

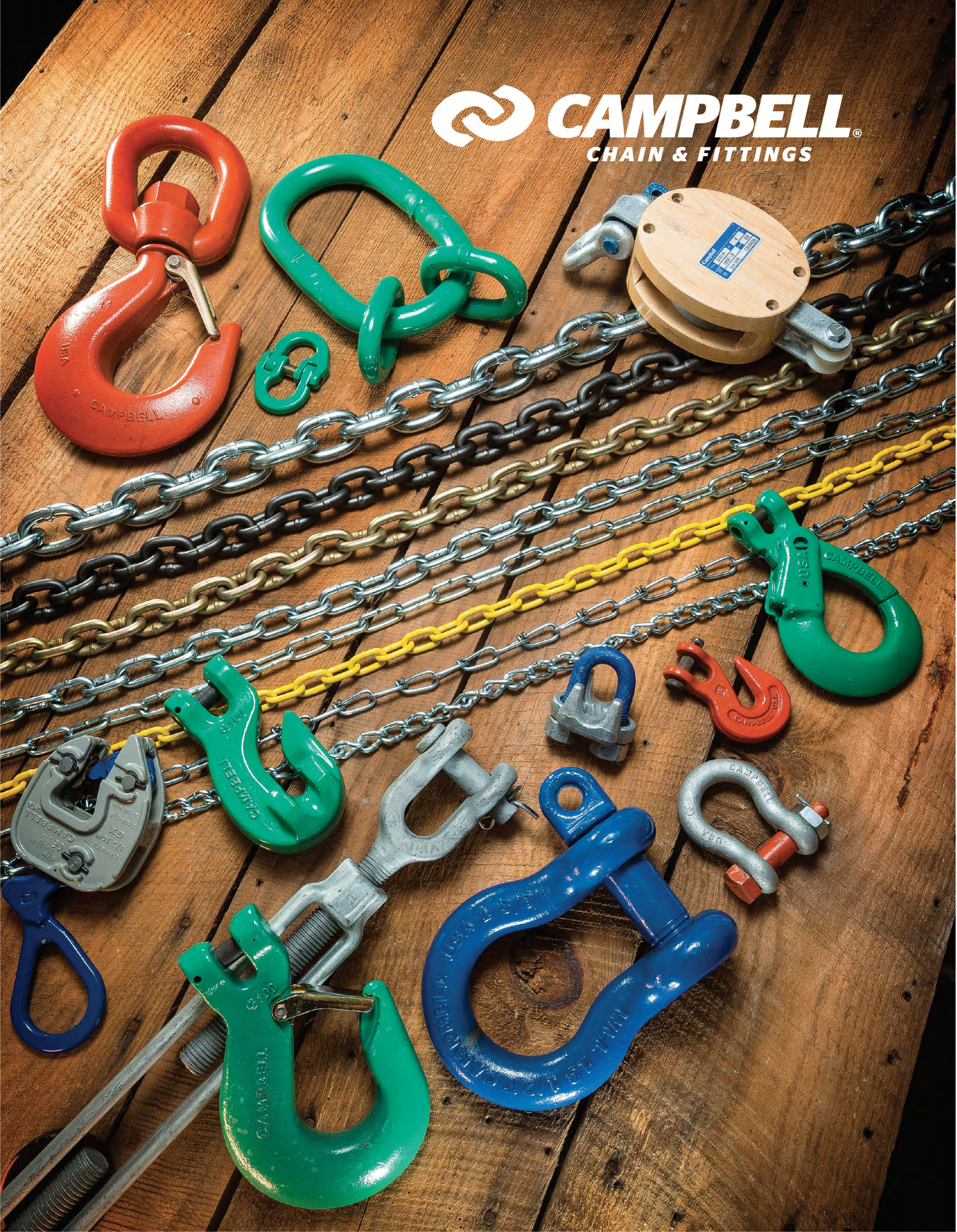

**CAMPBELL**<sup>®</sup>  
CHAIN & FITTINGS



Over the decades, thousands of tough applications and just as many demanding customers have forged the Campbell brand. Today, Campbell industrial rigging solutions stand for strength. Campbell industrial fittings are closed-die drop-forged for superior strength and performance, and all alloy lifting chains and associated alloy chain fittings are 100% load-tested to at least 2X the working load limit as “proof” of their reliability. Campbell chain and fittings are designed to maximize performance and expertly manufactured at our Pennsylvania and South Carolina plants by skilled American craftsmen. Trust Campbell performance: **100% American strong.**

### SINGLE-SOURCE RIGGING SOLUTIONS

Campbell's in-house team of chain, fitting and rigging specialists will find the right solution for your job. With more than 40 qualified technical and training professionals throughout North

America, you're never far from expert advice or the right answer. Campbell's technical support, expertise and training provide total customer satisfaction with our full line of material-handling products.

### WHEN YOU NEED IT NOW, CALL CAMPBELL FIRST

You have deadlines to meet, onsite inspections to pass, customers to satisfy. You have zero tolerance for downtime or delivery promises that aren't kept. So when you need 3,000 feet of Grade 100 chain or a replacement clamp ASAP or the job won't meet deadline, we'll deliver it fast to your jobsite from one of four Campbell distribution centers in the U.S. and Canada, even hot-shotting it your way, if necessary.

Whether you're positioning 6-metric ton steel plates on a new bridge or trucking heavy equipment and structures cross-country, there's no rigging job too challenging for Campbell. Specify Campbell chain and rigging solutions — **100% American strong.**



*Chain Products* ..... 3

*Accessories* ..... 46

*Fittings* ..... 72

*Blocks* ..... 112

*Slings* ..... 128

*Clamps* ..... 154

*Index* ..... 167



**CHAINS**

Grade 30 .....	7
Marine Proof .....	10
Mooring .....	11
BBB .....	11
Grade 43 .....	12
Sweep .....	14
Deck Lashing .....	14
Marine Alloy Trawl .....	15
Grade 70 .....	15
Marine .....	17
Grade 80/Grade 100.....	19
Stainless Steel/Aluminum .....	20
Straight/Twist Link.....	21
Studio .....	25
Passing Link .....	26
Handy Link Utility.....	27
Lock Link .....	28
Brass Plumber's .....	29
Inco.....	30
Single/Double Jack.....	32
Sash.....	34
Decorator/Hobby/Craft.....	35
Oval Link .....	37
Plastic.....	38
Cable.....	38
Wire Rope .....	40
Construction .....	41
Winch/Log.....	41
Binder .....	42
Tow .....	44
Pet .....	44
Porch Swing .....	45
Hydraulic Chain Cutters .....	45



## Campbell® Chain

Founded in 1919, Campbell® is the largest manufacturer of welded and weldless chain in the United States. Users of Campbell chain can select from a wide range of working load capacities including proof coil, high test, transport and alloy; finishes including self-colored, zinc plated, galvanized and bright color polycoated; links that are short, long, twisted, locked, looped, even stamped from flat stock. Several chain types are even available in solid brass and bronze. Campbell® chains and assemblies, including slings for overhead lifting, and binder chains, have earned for the manufacturer an outstanding reputation for quality.

## Important Chain Terms

### WORKING LOAD LIMIT

The “working load limit” (rated capacity) is the maximum combined static and dynamic load in pounds or kilograms that should never be applied to the product in service, even when the product is new, and when the load is uniformly applied in direct tension to the product.

### PROOF TEST

The “proof test” is a quality control test applied to chain for the purpose of verifying weld and material quality. It is the minimum force in pounds or newtons that the chain has withstood in

direct tension as part of the manufacturing process. Proof testing assures that the chain is more than capable of performing at its rated working load limit. Proof test loads are a manufacturing integrity test and shall not be used as criteria for service or design purposes. All Campbell proof tested chain and components are proof tested in accordance with the applicable ASTM, NACM and AISI/ASME requirements.

Campbell chain products and components are designed and built for rugged lasting service. As with any quality product certain precautions and standards of treatment should be observed.

## Finish Abbreviations

### (BRT) stands for Bright.

A finish where the surface is cleaned by shot peening or tumbling to produce a clean bright surface

### (GALV) stands for Hot-dip Galvanized.

Hot-dip galvanizing is a process where the chain is immersed in molten zinc. This produces both a chemical reaction between the steel and the zinc, as well as an outside layer of zinc on the chain. The end result is an adherent coating of zinc that is much thicker than that produced by zinc electroplating. Corrosion resistance is proportional to zinc thickness, and therefore galvanized products offer superior corrosion resistance to electroplated products.

*Note: Due to the temperature of the molten zinc, the strengths of hot-dip galvanized products are often reduced by 15%*

### (M-GALV) stands for Mechanically Galvanized.

Mechanical galvanizing is a process where zinc powder is mechanically applied to the outside of the chain. Because this is a mechanical process and not a molten process, the coating is very uniform.

### (Polycoated)

A finish where the chain is coated with a colored plastic powder which is then fused onto each link.

### (S.C.) stands for Self Colored.

A finish without any cleaning operations to remove oil or dirt or surface oxidation from the welding process

### (Y.C.) stands for Yellow Chromate.

A name for Campbell's method of zinc electroplating with a yellow chromate finish. The zinc electroplating is an attractive finish that also serves to prevent the onset of rust on the chain. The chromate finish serves to protect the zinc electroplate

### (Z.P.) stands for Zinc Plated.

Campbell's method of zinc electroplating. The zinc electroplating is an attractive finish that also serves to prevent the onset of rust on the chain.



## Campbell® CAMTROL System

Campbell's CAMTROL SYSTEM makes chain products easier to identify and understand. That's because all are based on engineering formulas computed according to ISO (International Organization for Standardization), NACM (National Association of Chain Manufacturers) and ASTM (American Society for Testing and Materials).

Use the CAMTROL SYSTEM to make wise chain purchasing decisions. Use it to compare the various categories of chain, to choose the right chain for the job according to the price per thousand pounds of working load instead of buying on a price per foot.

Consult your Campbell Chain distributor for current prices. Then refer to the chart below and divide the price per foot by the working load limit (in thousands of pounds) shown in the table. By using this comparison system you will discover that you can

buy a smaller, easier to handle chain, and at less cost based on its working load limit.

### Variations in Finish or Heat Treatment

The mechanical properties shown on the Camtrol Chart apply only to the various chains in their standard finish and heat treated condition. Finishes such as galvanizing or electroplating may reduce strengths. The manufacturer's revised recommendations should be solicited when such treatments are desirable for specific applications.

### Hallmarking (Identification)

All System 4, 7, 8, and 10 chains and all System 3 chains 5/16" (8 mm) and larger are marked with the grade identifier approximately every 12" or less. Please refer to the chain type of interest in this catalog for the specific hallmarks.

Grade	Camtrol System Number	Trade Size		Diameter		Nominal Dimensions				Weight Per 100 Feet		Working Load Limit	
		in.	mm	in.	mm	Inside Length		Inside Width		lb	kg	lb	kg
						in.	mm	in.	mm				
30	3	1/8	4	.156	4.0	.89	22.61	.29	7.33	22	10	400	180
30	3	3/16	5.5	.205	5.5	.95	24.13	.34	8.63	35	16	800	365
30	3	1/4	7	.260	7.0	1.20	30.50	.45	11.40	56	25	1,300	580
30	3	5/16	8	.312	8.0	1.27	32.27	.47	11.93	83	38	1,900	860
30	3	3/8	10	.369	10.0	1.36	34.46	.57	14.47	125	57	2,650	1,200
30	3	1/2	13	.480	13.0	1.70	43.18	.75	19.00	237	108	4,500	2,030
30	3	5/8	16	.656	16.7	2.10	53.34	.87	22.09	390	177	6,900	3,130
30	3	3/4	20	.781	19.8	2.70	68.58	1.02	26.00	535	243	10,600	4,810
30	3	7/8	22	.906	23.0	2.34	59.44	1.37	34.80	770	349	12,800	5,810
43	4	1/4	7	.276	7.0	1.20	30.50	.45	11.40	63	28	2,600	1,180
43	4	5/16	8	.330	8.4	1.27	32.27	.47	11.94	102	46	3,900	1,770
43	4	3/8	10	.394	10.0	1.15	29.21	.58	14.73	160	73	5,400	2,450
43	4	7/16	11.9	.468	11.9	1.29	32.77	.67	17.02	216	98	7,200	3,270
43	4	1/2	13	.531	13.0	1.70	43.18	.75	19.00	260	118	9,200	4,170
43	4	5/8	16	.656	16.7	1.94	49.27	.93	23.62	356	161	13,000	5,910
43	4	3/4	20	.781	23.0	2.21	56.13	1.10	27.94	535	243	20,200	9,180
70	7	1/4	7	.312	7.9	.94	23.88	.46	11.68	91	41	3,150	1,430
70	7	5/16	8.7	.343	8.7	1.01	25.65	.48	11.68	111	50	4,700	2,130
70	7	3/8	10	.406	10	1.36	34.46	.57	14.47	150	68	6,600	2,990
70	7	7/16	11.9	.468	11.9	1.29	32.77	.67	17.02	212	96	8,750	3,970
70	7	1/2	13	.531	13.0	1.70	43.18	.75	19.00	260	118	11,300	5,130
70	7	5/8	16	.630	16.0	1.93	49.02	.87	22.10	375	170	15,800	7,170
80	8	5/16	8	.315	8.0	.94	23.88	.46	11.68	92	42	4,500	2,000
80	8	1	26	1.000	25.4	2.80	71.12	1.40	35.56	965	438	47,700	21,600
80	8	1 1/4	32	1.250	31.8	3.50	88.90	1.75	44.45	1525	692	72,300	32,800
100	10	9/32	7	.285	7.2	.86	21.80	.41	11.40	74	34	4,300	1,950
100	10	3/8	10	.402	10.2	1.22	31.00	.55	14.00	148	67	8,800	3,990
100	10	1/2	13	.522	13.2	1.54	39.90	.45	19.10	250	113	15,000	6,800
100	10	5/8	16	.643	16.3	1.93	49.00	.87	22.10	379	172	22,600	10,250
100	10	3/4	20	.802	20.4	2.42	61.50	1.09	27.70	598	271	35,300	16,000
100	10	7/8	22	.882	22.4	2.70	68.52	1.28	32.48	775	351	42,700	19,400

## Warnings, Cautions, Inspection and Proper Use of Chain

Proper care will extend the useful life of the product.

### INSTRUCTIONS REGARDING COMPONENTS AND FITTINGS

Components, such as hooks or shackles, should have at least the same working load limit (rated capacity) as the chain with which they are used. If not, the assembly shall be rated to the capacity of the weakest component. Campbell offers a full line of components engineered specifically to be compatible with our chain products.

### WARNINGS AND CAUTIONS

- The use of chain is subject to certain hazards that cannot be met by mechanical or manufacturing means, but only by the exercise of intelligence, care, and common sense
- Do not exceed the working load limit of the chain or any component
- Chemically active environments may adversely affect chain and components. Do not use in highly acidic or caustic environments. Campbell should be contacted if the chain will be exposed to chemically active environments during use
- High and low temperatures will affect chain and components. Campbell should be contacted if temperatures below -20°F (-29°C) or above 400°F (200°C) will be experienced
- Chains used in certain applications are subject to governmental regulations. Please follow all Federal, State and/or Local Department of Transportation, OSHA, or other applicable standards and regulations when using Campbell products
- Never field weld or repair chain
- See other specific information under “Inspection and Proper Use”

### INSPECTION

Regular inspections should be conducted on chain to detect damage or deterioration from use. The chain should be inspected for any of the below conditions. If present, the chain should immediately be removed from service.

- Cracks in the chain or any component
- Excessive nicks or gouges
- Excessive wear. Chain should be removed from service if the thickness at any point on the link is below the value shown in the Chain Minimum Allowable Thickness chart. All other components should be removed from service if any dimension is worn by more than 10% from the original dimension
- Stretched, bent, twisted, or distorted chain links or components
- Excessive corrosion
- Evidence of heat damage
- Evidence of field welding or weld splatter
- Any other condition which questions the integrity of the chain

### PROPER USE

To protect the users and to prevent damage to the chain, the following safe practices should be followed:

- Select a chain suitable for the application and environment
- The hooks or other components should be of a size to fit the intended connections
- Avoid shock loading
- Pad all sharp edges or corners in contact with the chain
- Rig so that the load is properly seated in the hooks or other components. Avoid tip loading of hooks and side loading of chain and components
- Avoid twisting or kinking the chain
- Never knot chain

Purchasers please note that all “Warnings and Cautions” apply to chain as well as all components and fittings. Purchasers are responsible for conveying the “Warnings and Cautions,” including the “Inspection” and “Proper Use” section information to the end user.

Campbell denies any liability for damage that results from use in excess of the working load limit or any abuse or misuse of the product.

Any questions concerning the use of Campbell products may be directed to your Apex Tool Group Sales representative or Apex Tool Group Customer Service representative.

### OTHER PRODUCTS

Campbell produces a number of products for specialty applications. Please contact your Apex Tool Group Sales representative, or Customer Service representative, if you have special requirements.

Not all products produced by Campbell appear in this catalog. Campbell can produce engineered chain to meet customer design specifications, and also produces a variety of chain assemblies. Minimum order quantities may apply to special order products.

*NOTICE: The product specifications and dimensions are as accurate as possible at the time of printing. However, because we are continually improving the quality and design of our products, they can change without notice. The dimensions and weights are approximate nominal values, and some variation will occur. If specific dimensional requirements are necessary for the application, please contact your Apex Tool Group Sales representative, or Customer Service representative.*



## Chain Minimum Allowable Thickness Chart

Trade Size		Chain Type or Grade	Nominal Material Diameter		Min. Allowable Thickness on Link	
in.	mm		in.	mm	in.	mm
4	3.0	Machine, Coil	0.120	3.0	0.104	2.64
3	3.4	Machine, Coil	0.135	3.4	0.117	2.97
2	3.8	Machine, Coil	0.148	3.8	0.128	3.25
1	4.1	Machine, Coil	0.162	4.1	0.140	3.56
1/0	4.5	Machine, Coil	0.177	4.5	0.153	3.89
2/0	4.9	Machine, Coil, Passing Link	0.192	4.9	0.166	4.22
3/0	5.3	Machine, Coil	0.207	5.3	0.179	4.55
4/0	5.5	Machine, Coil, Passing Link	0.218	5.5	0.189	4.80
5/0	6.4	Machine, Coil	0.250	6.4	0.217	5.50
1/8	4.0	Grade 30	0.156	4.0	0.135	3.43
3/16	5.5	Grade 30, 80, 100	0.217	5.5	0.189	4.80
1/4-9/32	7.0	Grade 30, 43, 70, 80, 100 (Grade 43 = 0.281)	0.276	7.0	0.239	6.07
5/16	8.4	Grade 30	0.331	8.4	0.286	7.28
5/16	8.7	Grade 43, 70	0.343	8.7	0.297	7.54
5/16	8.0	Grade 80, 100	0.312	8.0	0.273	6.93
3/8	10.0	Grade 30, 80, 100	0.394	10.0	0.342	8.69
3/8	10.3	Grade 43, 70	0.406	10.3	0.351	8.93
7/16	11.9	Grade 30, 43, 70	0.468	11.9	0.405	10.30
1/2	13.0	Grade 30, 80, 100	0.512	13.0	0.443	11.26
1/2	13.5	Grade 43, 70	0.531	13.5	0.460	11.68
5/8	16.0	Grade 30, 43, 70	0.630	16.0	0.546	13.87
3/4	20.0	Grade 80, 100	0.787	20.0	0.687	17.45
7/8	20.0	Grade 30, 43, 80, 100	0.866	22.0	0.750	19.05
1	26.0	Grade 30, 80	1.020	26.0	0.887	22.53
1-1/4	32.0	Grade 80	1.260	32.0	1.091	27.71
1-1/2	38.0	Grade 63	1.500	38.0	1.300	32.99

 **Warning:** Remove chain from service if the thickness is less than the minimum shown, at any location on the link

### ADVERTENCIA

Para prevenir la posibilidad de una lesión personal seria:

- **NO EXCEDA** los límites de carga de las cadenas o componentes.
- **NO LA UTILICE** para cargar hacia arriba o para izar.
- **NO LA UTILICE** si la cadena o los componentes están visualmente distorsionados o gastados.

### WARNING

To prevent the possibility of serious bodily injury:

- **DO NOT EXCEED** the working load limits for chain or components.
- **DO NOT USE** for overhead lifting or hoisting.
- **DO NOT USE** if the chain or components are visibly distorted or worn.



## Grade 30, Proof Coil Chain - Drums

- Excellent Low Carbon Steel Chain for General Purpose Applications
- Frequently Used for Fabricating Tow Chains, Binding and Logging Chains, Marine and Other General Applications
- Standard Finish: Self Colored, Zinc Plated or Galvanized
- Hallmarking: "C3" and "USA" on 5/16" and Larger
- Proof Tested
- Design Factor: 4 to 1
- Packaged in Drums, Order Unit is "Feet"
- Made in the USA
- Do Not Use for Overhead Lifting
- DO NOT EXCEED THE WORKING LOAD LIMIT



Trade Size	Self-Colored		Zinc Plated		Galvanized		Material Diameter	Inside Length	Inside Width	Working Load Limit	Feet Per Pkg.	Links Per Foot	Weight Per Pkg.
	Catalog No.	UPC No. 020418	Catalog No.	UPC No. 020418	Catalog No.	UPC No. 020418							
1/8 in	0120202	056932	—	—	0120232	056949	0.16 in	0.89 in	0.29 in	400 lb	1000 ft	13.5	190 lb
3/16 in	0120302	056970	0120322	057007	0120332	057045	0.21 in	0.95 in	0.34 in	800 lb	1000 ft	12.6	350 lb
1/4 in	0120402	057076	0120422	057106	0120432	057144	0.26 in	1.20 in	0.45 in	1300 lb	800 ft	10	460 lb
5/16 in	0120502	057205	0120522	057243	0120532	057281	0.31 in	1.27 in	0.47 in	1900 lb	550 ft	9.4	482 lb
3/8 in	0120602	057335	0120622	057373	0120632	057410	0.37 in	1.36 in	0.57 in	2650 lb	400 ft	8.8	500 lb
7/16 in	—	—	—	—	0120732	057489	0.47 in	1.37 in	0.75 in	3700 lb	300 ft	8.8	660 lb
1/2 in	0120802	057502	0120822	057526	0120832	057557	0.48 in	1.70 in	0.75 in	4500 lb	200 ft	7.1	420 lb
5/8 in	0121002	057595	—	—	0121032	057618	0.66 in	2.10 in	0.87 in	6900 lb	150 ft	5.7	610 lb
3/4 in	0121202	057632	—	—	0121232	057656	0.78 in	2.70 in	1.02 in	10600 lb	100 ft	4.4	560 lb

## Grade 30, Proof Coil Chain - Half Drums

- Excellent Low Carbon Steel Chain for General Purpose Applications
- Frequently Used for Fabricating Tow Chains, Binding and Logging Chains, Marine and Other General Applications
- Standard Finish: Self Colored or Galvanized
- Hallmarking: "C3" and "USA" on 5/16" and Larger
- Proof Tested
- Design Factor: 4 to 1
- Packaged in Half Drums, Order Unit is "Feet"
- Made in the USA
- Do Not Use for Overhead Lifting
- DO NOT EXCEED THE WORKING LOAD LIMIT



Trade Size	Self-Colored		Galvanized		Material Diameter	Inside Length	Inside Width	Working Load Limit	Feet Per Package	Links Per Foot	Weight Per Package
	Catalog No.	UPC No. 020418	Catalog No.	UPC No. 020418							
3/16 in	0120300	056956	0120330	057021	0.21 in	0.95 in	0.34 in	800 lb	500 ft	12.6	175 lb
1/4 in	0120400	057052	0120430	057120	0.26 in	1.20 in	0.45 in	1300 lb	400 ft	10	230 lb
5/16 in	0120500	057182	0120530	057267	0.31 in	1.27 in	0.47 in	1900 lb	275 ft	9.4	241 lb
3/8 in	0120600	057311	0120630	057397	0.37 in	1.36 in	0.57 in	2650 lb	200 ft	8.8	250 lb





## Grade 30, Proof Coil Chain - Round Pails

- Excellent Low Carbon Steel Chain for General Purpose Applications
- Frequently Used for Fabricating Tow Chains, Binding and Logging Chains, Marine and Other General Applications
- Standard Finish: Zinc Plated or Galvanized
- Hallmarking: "C3" and "USA" on 5/16" and Larger
- Proof Tested
- Design Factor: 4 to 1
- Packaged in Pails, Order Unit is "Each"
- Made in the USA
- Do Not Use for Overhead Lifting
- DO NOT EXCEED THE WORKING LOAD LIMIT



Trade Size	Zinc Plated		Galvanized		Material Diameter	Inside Length	Inside Width	Working Load Limit	Feet Per Package	Links Per Foot	Weight Per Package
	Catalog No.	UPC No. 020418	Catalog No.	UPC No. 020418							
3/16 in	0140323	057991	0140333	058004	0.21 in	0.95 in	0.34 in	800 lb	250 ft	12.6	88 lb
1/4 in	0140423	058028	0140433	058035	0.26 in	1.20 in	0.45 in	1300 lb	141 ft	10	79 lb
5/16 in	0140523	058059	0140533	058066	0.31 in	1.27 in	0.47 in	1900 lb	92 ft	9.4	76 lb
3/8 in	0140623	058080	0140633	058097	0.37 in	1.36 in	0.57 in	2650 lb	63 ft	8.8	79 lb
1/2 in	0140823	058103	—	—	0.48 in	1.70 in	0.75 in	4500 lb	40 ft	7.1	95 lb

## Grade 30, Anchor Lead, Proof Coil Chain - Square Pails

- Excellent Low Carbon Steel Chain for General Purpose Applications
- Frequently Used As Anchor Lead Chain for Marine Applications
- Standard Finish: Galvanized and Polycoated White
- Hallmarking: "C3" and "USA" on 5/16" and Larger
- Proof Tested
- Design Factor: 4 to 1
- Order Unit is "Each"
- Made in the USA
- Do Not Use for Overhead Lifting
- DO NOT EXCEED THE WORKING LOAD LIMIT



Trade Size	Catalog No.	UPC No. 020418	Material Diameter	Inside Length	Inside Width	Finish	Working Load Limit	Feet Per Package	Links Per Foot	Weight Per Package
5/16 in	0200356	183881	0.31 in	1.27 in	0.47 in	Galvanized & Polycoated White	1900 lb	75 ft	9.4	62 lb



## Grade 30, Proof Coil Chain - Square Pails

- Excellent Low Carbon Steel Chain for General Purpose Applications
- Frequently Used for Fabricating Tow Chains, Binding and Logging Chains, Marine and Other General Applications
- Standard Finish: Zinc Plated or Galvanized
- Hallmarking: "C3" and "USA" on 5/16" and Larger
- Proof Tested
- Design Factor: 4 to 1
- Packaged in Pails, Order Unit is "Each"
- Made in the USA
- Do Not Use for Overhead Lifting
- DO NOT EXCEED THE WORKING LOAD LIMIT



Trade Size	Self-Colored		Zinc Plated		Galvanized		Material Diameter	Inside Length	Inside Width	Working Load Limit	Feet Per Package	Links Per Foot	Weight Per Package
	Catalog No.	UPC No. 020418	Catalog No.	UPC No. 020418	Catalog No.	UPC No. 020418							
1/8 in	—	—	0143226	190360	—	—	0.16 in	0.89 in	0.29 in	400 lb	200 ft	13.5	38 lb
3/16 in	—	—	0143326	183058	0143336	183065	0.21 in	0.95 in	0.34 in	800 lb	150 ft	12.6	53 lb
1/4 in	—	—	0143426	183072	0143436	183089	0.26 in	1.20 in	0.45 in	1300 lb	100 ft	10	56 lb
5/16 in	0143516	190681	0143526	183096	0143536	183102	0.31 in	1.27 in	0.47 in	1900 lb	75 ft	9.4	62 lb
3/8 in	—	—	0143626	183119	0143636	183126	0.37 in	1.36 in	0.57 in	2650 lb	45 ft	8.8	56 lb

## Grade 30, Polycoated, Proof Coil Chain - Square Pails

- Excellent Low Carbon Steel Chain for General Purpose Applications
- Frequently Used for Swing Sets, Borders, Crowd Control and Other General Applications
- Standard Finish: Polycoated Yellow or Hi-Visibility Orange
- Hallmarking: "C3" and "USA" on 5/16" and Larger
- Proof Tested
- Design Factor: 4 to 1
- Order Unit is "Each"
- Made in the USA
- Do Not Use for Overhead Lifting
- DO NOT EXCEED THE WORKING LOAD LIMIT



Trade Size	Catalog No.	UPC No. 020418	Material Diameter	Inside Length	Inside Width	Finish	Working Load Limit	Feet Per Package	Links Per Foot	Weight Per Package	Shelf Pack
1/4 in	PD0143426	212185	0.26 in	1.20 in	0.45 in	Yellow Polycoat	1300 lb	75 ft	10	45 lb	1
5/16 in	HV0142526	187940	0.31 in	1.27 in	0.47 in	Hi-Visibility Orange Polycoat	1900 lb	75 ft	9.4	62 lb	1



## Grade 30, Proof Coil Chain - Reels



- Excellent Low Carbon Steel Chain for General Purpose Applications
- Frequently Used for Swing Sets, Borders, Crowd Control and Other General Applications
- Standard Finish: Zinc Plated or Polycoated Yellow
- Hallmarking: "C3" and "USA" on 5/16" and Larger
- Proof Tested
- Design Factor: 4 to 1
- Packaged on Reels, Order Unit is "Each"
- Made in the USA
- Do Not Use for Overhead Lifting
- DO NOT EXCEED THE WORKING LOAD LIMIT



Trade Size	Zinc Plated		Yellow Polycoat		Material Diameter	Inside Length	Inside Width	Working Load Limit	Feet Per Package	Links Per Foot	Weight Per Package
	Catalog No.	UPC No. 020418	Catalog No.	UPC No. 020418							
3/16 in	0725027	064982	PD0725027	184642	0.21 in	0.95 in	0.34 in	800 lb	100 ft	10.75	38 lb
1/4 in	0722127	183270	—	—	0.26 in	1.20 in	0.45 in	1300 lb	65 ft	10.75	41 lb
1/4 in	—	—	PD0722127	183393	0.26 in	1.20 in	0.45 in	1300 lb	60 ft	10.75	36 lb
5/16 in	0722227	183287	—	—	0.31 in	1.27 in	0.47 in	1900 lb	60 ft	10.75	50 lb
3/8 in	0722327	183294	—	—	0.37 in	1.36 in	0.57 in	2650 lb	35 ft	10.75	44 lb

## Marine Proof Coil Chain - Drums



- Excellent Low-Carbon Steel Chain Made with A Shorter Link Length Than Standard Proof Coil
- Proof Tested
- Hallmarking: "C3"
- Design Factor: 4 to 1
- Packaged in Drums, Order Unit is "Feet"
- Made in the USA
- Do Not Use for Overhead Lifting
- DO NOT EXCEED THE WORKING LOAD LIMIT



Trade Size	Self-Colored		Hot Galvanized		Material Diameter	Inside Length	Inside Width	Working Load Limit	Feet Per Package	Links Per Foot	Weight Per Package
	Catalog No.	UPC No. 020418	Catalog No.	UPC No. 020418							
1/4 in	0128102*	182969	0128132	170645	0.28 in	1.00 in	0.50 in	1300 lb	800 ft	12	584 lb
5/16 in	—	—	0128232	170652	0.34 in	1.10 in	0.50 in	1900 lb	550 ft	11	561 lb
3/8 in	0128302*	182983	0128332	170669	0.41 in	1.23 in	0.62 in	2650 lb	400 ft	9.7	640 lb
1/2 in	—	—	0128432	170676	0.53 in	1.50 in	0.81 in	4500 lb	200 ft	7.8	554 lb

\* These Items are Made to Order



## Mooring Chain - Drums

- Excellent Low Carbon Steel Chain with A Long Link Design for Mooring Applications
- The Longer Link Allows the Use of A Shackle Anywhere in the Length of Chain, Not Just at End Links
- Greater Working Load Limit Than Proof Coil
- Hot Dipped Galvanized Finish
- Hallmarking: "MC" and "USA"
- Proof Tested
- Design Factor: 4 to 1
- Made in the USA
- Do Not Use for Overhead Lifting
- DO NOT EXCEED THE WORKING LOAD LIMIT



Trade Size	Catalog No.	UPC No. 020418	Material Diameter	Inside Length	Inside Width	Working Load Limit	Feet Per Package	Links Per Foot	Weight Per Package
3/8 in	0129332	152108	0.41 in	1.23 in	0.62 in	3700 lb	400 ft	9.7	536 lb
1/2 in	0129432	152092	0.51 in	2.05 in	0.83 in	6000 lb	200 ft	8	460 lb
5/8 in	0129532	152078	0.63 in	2.52 in	0.94 in	9000 lb	150 ft	4.7	510 lb
3/4 in	0129632	152085	0.79 in	3.00 in	1.16 in	13500 lb	100 ft	4	554 lb

## BBB Chain - Drums

- Especially Made for Windlass or Pocket Wheel Applications
- Standard Material: Low Carbon Steel
- Standard Finish: Self-Colored (S/C)
- Proof Tested
- Hallmarking: "CB" and "USA"
- Design Factor: 4 to 1
- Packaged in Drums, Order Unit is "Feet"
- Made in the USA
- Do Not Use for Overhead Lifting
- DO NOT EXCEED THE WORKING LOAD LIMIT



Trade Size	Catalog No.	UPC No. 020418	Material Diameter	Inside Length	Inside Width	Finish	Working Load Limit	Feet Per Package	Links Per Foot	Weight Per Package
9/16 in	0150902	058493	0.59 in	1.58 in	0.78 in	Self-Colored	8000 lb	200 ft	7	700 lb



## Grade 43, High Test Chain - Drums



- Designed for Use in Load Binding, Towing, Logging and Other Applications Requiring High Strength
- Standard Material: Carbon Steel
- Standard Finish: Self Colored or Bright, Zinc Plated or Galvanized
- Hallmarking: "C4" All Sizes and "USA" on 1/4" and 5/16"
- Proof Tested
- Design Factor: 3 to 1
- Packaged in Drums, Order Unit is "Feet"
- Made in the USA
- Do Not Use for Overhead Lifting
- DO NOT EXCEED THE WORKING LOAD LIMIT



Trade Size	Catalog No.	UPC No. 020418	Material Diameter	Inside Length	Inside Width	Finish	Working Load Limit	Feet Per Package	Links Per Foot	Weight Per Package
1/4 in	0180412	058769	0.28 in	1.20 in	0.45 in	Self-Colored	2600 lb	800 ft	10	504 lb
1/4 in	0180422	058790	0.28 in	1.20 in	0.45 in	Zinc Plated	2600 lb	800 ft	10	504 lb
1/4 in	0180432	058820	0.28 in	1.20 in	0.45 in	Galvanized	2600 lb	800 ft	10	504 lb
5/16 in	0180512	058851	0.33 in	1.27 in	0.47 in	Self-Colored	3900 lb	550 ft	9.4	523 lb
5/16 in	0180522	058882	0.33 in	1.27 in	0.47 in	Zinc Plated	3900 lb	550 ft	9.4	523 lb
5/16 in	0180532	058912	0.33 in	1.27 in	0.47 in	Galvanized	3900 lb	550 ft	9.4	523 lb
3/8 in	0180612	058943	0.38 in	1.36 in	0.58 in	Self-Colored	5400 lb	400 ft	8.8	520 lb
3/8 in	0180632	059018	0.38 in	1.36 in	0.58 in	Galvanized	5400 lb	400 ft	8.8	520 lb
1/2 in	0180812	059094	0.53 in	1.70 in	0.75 in	Self-Colored	9200 lb	200 ft	7.1	520 lb
1/2 in	0180832	059155	0.53 in	1.70 in	0.75 in	Galvanized	9200 lb	200 ft	7.1	520 lb
5/8 in	0181012	059186	0.66 in	1.94 in	0.93 in	Bright	13000 lb	150 ft	6.2	534 lb
5/8 in	0181032	059216	0.66 in	1.94 in	0.93 in	Galvanized	13000 lb	150 ft	6.2	534 lb
3/4 in	0181212	059254	0.78 in	2.21 in	1.10 in	Bright	20200 lb	100 ft	5.4	581 lb

## Grade 43, Polycoated, High Test Chain - Square Pails



- Designed for Use in Load Binding, Towing, Logging and Other Applications Requiring High Strength
- Standard Material: Carbon Steel
- Standard Finish: Polycoated Hi-Visibility Orange
- Hallmarking: "C4" All Sizes and "USA" on 1/4" and 5/16"
- Proof Tested
- Design Factor: 3 to 1
- Packaged in Pails, Order Unit is "Each"
- Made in the USA
- Do Not Use for Overhead Lifting
- DO NOT EXCEED THE WORKING LOAD LIMIT



Trade Size	Catalog No.	UPC No. 020418	Material Diameter	Inside Length	Inside Width	Finish	Working Load Limit	Feet Per Package	Links Per Foot	Weight Per Package
5/16 in	HV0184526	187698	0.33 in	1.27 in	0.47 in	Hi-Visibility Orange Polycoat	3900 lb	60 ft	9.4	50 lb



## Grade 43, High Test Chain - Round Pails

- Designed for Use in Load Binding, Towing, Logging and Other Applications Requiring High Strength
- Standard Material: Carbon Steel
- Standard Finish: Bright and Zinc Plated
- Hallmarking: "C4" All Sizes and "USA" on 1/4" and 5/16"
- Proof Tested
- Design Factor: 3 to 1
- Packaged in Pails, Order Unit is "Each"
- Made in the USA
- Do Not Use for Overhead Lifting
- DO NOT EXCEED THE WORKING LOAD LIMIT



Trade Size	Bright		Zinc Plated		Material Diameter	Inside Length	Inside Width	Working Load Limit	Feet Per Package	Links Per Foot	Weight Per Package
	Catalog No.	UPC No. 020418	Catalog No.	UPC No. 020418							
1/4 in	0181413	059278	0181423	059285	0.28 in	1.20 in	0.45 in	2600 lb	150 ft	10	98 lb
5/16 in	0181513	059292	0181523	059308	0.33 in	1.27 in	0.47 in	3900 lb	100 ft	9.4	95 lb
3/8 in	0181613	059315	0181623	059322	0.38 in	1.36 in	0.58 in	5400 lb	75 ft	8.8	98 lb

## Grade 43, High Test Chain - Square Pails

- Designed for Use in Load Binding, Towing, Logging and Other Applications Requiring High Strength
- Standard Material: Carbon Steel
- Standard Finish: Bright and Galvanized
- Hallmarking: "C4" All Sizes and "USA" on 1/4" and 5/16"
- Proof Tested
- Design Factor: 3 to 1
- Packaged in Pails, Order Unit is "Each"
- Made in the USA
- Do Not Use for Overhead Lifting
- DO NOT EXCEED THE WORKING LOAD LIMIT



Trade Size	Bright		Galvanized		Material Diameter	Inside Length	Inside Width	Working Load Limit	Feet Per Package	Links Per Foot	Weight Per Package
	Catalog No.	UPC No. 020418	Catalog No.	UPC No. 020418+							
1/4 in	0184416	183133	—	—	0.28 in	1.20 in	0.45 in	2600 lb	100 ft	10	66 lb
5/16 in	0184516	183140	0184536	185878	0.33 in	1.27 in	0.47 in	3900 lb	60 ft	9.4	57 lb
3/8 in	0184616	183157	0184636	185885	0.38 in	1.36 in	0.58 in	5400 lb	40 ft	8.8	52 lb



## Sweep Chain - Drums

- Produced Specifically for Scallop and Oyster Dredging
- Thru Hardened for Wear Resistance
- Hallmarking: "CC" and "USA"
- Proof Tested
- Design Factor: 4 to 1
- Packaged in Drums, Order Unit is "Feet"
- Made in the USA
- Do Not Use for Overhead Lifting
- DO NOT EXCEED THE WORKING LOAD LIMIT



Trade Size	Catalog No.	UPC No. 020418	Material Diameter	Inside Length	Inside Width	Working Load Limit	Feet Per Package	Links Per Foot	Weight Per Package
5/8 in	0181092	179921	0.66 in	1.94 in	0.93 in	15800 lb	150 ft	6.2	614 lb

## Deck Lashing Chain

- Used to Secure Cargo on Ship Decks
- Features a Long Link Design
- Heat Treated Carbon Steel
- Hot Galvanized Finish
- Proof Tested
- Hallmarking: "CCL" and "USA"
- Design Factor: 4 to 1
- Complaint with "Canadian Code of Safe Practice for Ships Carrying Timber Deck Cargoes (TP 2534E-1992)
- Packaged in Pallet Box, Order Unit is "Feet"
- DO NOT EXCEED THE WORKING LOAD LIMIT



Trade Size	Catalog No.	UPC No. 020418	Material Diameter	Inside Length	Inside Width	Working Load Limit	Feet Per Package	Links Per Foot	Weight Per Package	Shelf Pack
1/2 in	0187232	181511	0.53 in	3.15 in	0.99 in	9000 lb	1000 ft	3.8	2200 lb	1

## Marine Alloy Trawl Chain - Drums

- Made of High Strength, Heat Treated Alloy Steel
- Designed for Use with the Larger Nets in the Trawling Industry
- Special Heat Treatment for the Trawling Industry
- Grade 80 Strengths
- Hallmarking: "NETS8" and Date Code
- Proof Tested
- Design Factor: 4 to 1
- Packaged in Drums, Order Unit is "Feet"
- Made in the USA
- DO NOT EXCEED THE WORKING LOAD LIMIT



Midlink



Long Link

Trade Size	Catalog No.	UPC No.	Chain Type	Inside Length	Inside Width	Working Load Limit	Feet Per Package	Weight Per Package
1/2 in	0407512	190452	Long Link	3.15 in	0.97 in	12000 lb	300 ft	570 lb
5/8 in	0407612*		Long Link	3.71 in	1.00 in	18100 lb	150 ft	473 lb
3/4 in	0407712	190476	Long Link	3.99 in	1.29 in	28300 lb	100 ft	480 lb
7/8 in	0406812*	190445	Midlink	4.00 in	1.15 in	34200 lb	100 ft	660 lb

\* These Items are Made to Order

## Grade 70, Transport Chain - Drums

- Designed for Use in Load Binding, Towing, Logging and Other Applications Requiring High Strength
- Can Be Used in Accordance with Department of Transportation Regulations
- Standard Material: Heat Treated Carbon Steel
- Standard Finish: Zinc Electroplate with Yellow Chromate Conversion Coating
- Hallmarking: "C7" and "USA"
- Proof Tested
- Design Factor: 4 to 1
- Packaged in Drums, Order Unit is "Feet"
- Do Not Use for Overhead Lifting
- DO NOT EXCEED THE WORKING LOAD LIMIT



Trade Size	Catalog No.	UPC No.	Material Diameter	Inside Length	Inside Width	Finish	Working Load Limit	Feet Per Package	Links Per Foot	Weight Per Package
1/4 in	0510412	063763	0.31 in	0.94 in	0.46 in	Yellow Chromate	3150 lb	800 ft	12.8	752 lb
5/16 in	0510512	063800	0.33 in	1.15 in	0.48 in	Yellow Chromate	4700 lb	550 ft	10.4	561 lb
3/8 in	0510612	063848	0.40 in	1.36 in	0.57 in	Yellow Chromate	6600 lb	400 ft	8.8	600 lb
7/16 in	0510712	063886	0.47 in	1.29 in	0.67 in	Yellow Chromate	8750 lb	300 ft	9.3	636 lb
1/2 in	0510812	063916	0.53 in	1.70 in	0.75 in	Yellow Chromate	11300 lb	200 ft	7.1	520 lb





## Grade 70, Transport Chain - Half Drums



- Designed for Use in Load Binding, Towing, Logging and Other Applications Requiring High Strength
- Can Be Used in Accordance with Department of Transportation Regulations
- Standard Material: Heat Treated Carbon Steel
- Standard Finish: Zinc Electroplate with Yellow Chromate Conversion Coating
- Hallmarking: "C7" and "USA"
- Proof Tested
- Design Factor: 4 to 1
- Packaged in Half Drums, Order Unit is "Feet"
- Do Not Use for Overhead Lifting
- DO NOT EXCEED THE WORKING LOAD LIMIT



Trade Size	Catalog No.	UPC No. 020418	Material Diameter	Inside Length	Inside Width	Finish	Working Load Limit	Feet Per Package	Links Per Foot	Weight Per Package
1/4 in	0510410	063749	0.31 in	0.94 in	0.46 in	Yellow Chromate	3150 lb	400 ft	12.8	376 lb
5/16 in	0510510	063787	0.33 in	1.15 in	0.48 in	Yellow Chromate	4700 lb	275 ft	10.4	280 lb
3/8 in	0510610	063824	0.40 in	1.36 in	0.57 in	Yellow Chromate	6600 lb	200 ft	8.8	300 lb
1/2 in	0510810	063893	0.53 in	1.70 in	0.75 in	Yellow Chromate	11300 lb	100 ft	7.1	260 lb

## Grade 70, Transport Chain - Round Pails



- Designed for Use in Load Binding, Towing, Logging and Other Applications Requiring High Strength
- Can Be Used in Accordance with Department of Transportation Regulations
- Standard Material: Heat Treated Carbon Steel
- Standard Finish: Zinc Electroplate with Yellow Chromate Conversion Coating
- Hallmarking: "C7" and "USA"
- Proof Tested
- Design Factor: 4 to 1
- Packaged in Pails, Order Unit is "Each"
- Do Not Use for Overhead Lifting
- DO NOT EXCEED THE WORKING LOAD LIMIT



Trade Size	Catalog No.	UPC No. 020418	Material Diameter	Inside Length	Inside Width	Finish	Working Load Limit	Feet Per Package	Links Per Foot	Weight Per Package
1/4 in	0510413	063770	0.31 in	0.94 in	0.46 in	Yellow Chromate	3150 lb	150 ft	12.8	139 lb
5/16 in	0510513	063817	0.33 in	1.15 in	0.48 in	Yellow Chromate	4700 lb	100 ft	10.4	102 lb
3/8 in	0510613	063855	0.40 in	1.36 in	0.57 in	Yellow Chromate	6600 lb	75 ft	8.8	113 lb



## Grade 70, Transport Chain - Square Pails

- Designed for Use in Load Binding, Towing, Logging and Other Applications Requiring High Strength
- Can Be Used in Accordance with Department of Transportation Regulations
- Standard Material: Heat Treated Carbon Steel
- Standard Finish: Zinc Electroplate with Yellow Chromate Conversion Coating
- Hallmarking: "C7" and "USA"
- Proof Tested
- Design Factor: 4 to 1
- Packaged in Pails, Order Unit is "Each"
- Do Not Use for Overhead Lifting
- DO NOT EXCEED THE WORKING LOAD LIMIT



Trade Size	Catalog No.	UPC No. 020418	Material Diameter	Inside Length	Inside Width	Finish	Working Load Limit	Feet Per Package	Links Per Foot	Weight Per Package
1/4 in	0510426	183867	0.31 in	0.94 in	0.46 in	Yellow Chromate	3150 lb	65 ft	12.8	64 lb
5/16 in	0510526	183874	0.33 in	1.15 in	0.48 in	Yellow Chromate	4700 lb	50 ft	10.4	51 lb
3/8 in	0510626	186639	0.40 in	1.36 in	0.57 in	Yellow Chromate	6600 lb	45 ft	8.8	68 lb

## Tuna Net Chain - Drums

- Made of High Strength, Heat Treated Steel
- Designed for Sinkers Lines and Bridles in Purse Seining
- Hot Dip Galvanized Finish
- Hallmarking: "ST" and "USA"
- Proof Tested
- Packaged in Drums, Order Unit is "Feet"
- Made in the USA
- Do Not Use for Overhead Lifting
- DO NOT EXCEED THE WORKING LOAD LIMIT



Trade Size	Catalog No.	UPC No. 020418	Material Diameter	Inside Length	Inside Width	Working Load Limit	Feet Per Package	Links Per Foot	Weight Per Package
3/8 in	0514632	175480	0.41 in	1.36 in	0.57 in	5600 lb	400 ft	9.75	620 lb
7/16 in	0514732	064241	0.47 in	1.37 in	0.75 in	7500 lb	300 ft	8.75	651 lb
1/2 in	0514832	064272	0.50 in	1.70 in	0.75 in	9600 lb	200 ft	7.75	476 lb
5/8 in	0514932	177507	0.63 in	1.93 in	0.87 in	13500 lb	150 ft	6.25	563 lb



## Dock Fender Chain - Drums



- High Tensile Chain Holds Thick Rubber Fenders to Dock Sides
- Hot Dipped Galvanized Finish
- Proof Tested
- Hallmarking: "C-DF"
- Packaged in Drums, Order Unit is "Feet"
- Made in the USA
- Do Not Use for Overhead Lifting
- DO NOT EXCEED THE WORKING LOAD LIMIT



Trade Size	Catalog No.	UPC No. 020418	Material Diameter	Inside Length	Inside Width	Working Load Limit	Feet Per Package	Weight Per Package
5/8 in	0516531*	181887	0.66 in	3.75 in	0.90 in	12500 lb	150 ft	480 lb
3/4 in	0516631*	181894	0.78 in	3.75 in	1.13 in	22300 lb	100 ft	446 lb

\* Item is Made to Order

## Beacon Fishing Chain



- Standard Material: Heat Treated Carbon Steel
- Standard Finish: Bright (Brt)
- Proof Tested
- Hallmarking: "CB" and "USA"
- Uses: Designed to Accommodate All Types of Chain Needs in the Trawling and Marine Industry
- Packaged in Drums, Order Unit is "Feet"
- Made in the USA
- Do Not Use for Overhead Lifting
- DO NOT EXCEED THE WORKING LOAD LIMIT



Trade Size	Catalog No.	UPC No. 020418	Material Diameter	Inside Length	Inside Width	Working Load Limit	Feet Per Package	Links Per Foot	Weight Per Package
3/8 in	0520612	064302	0.39 in	1.58 in	0.59 in	6600 lb	200 ft	7.6	268 lb
1/2 in	0520812	064319	0.51 in	2.05 in	0.83 in	11300 lb	200 ft	5.9	460 lb
5/8 in	0521012	064326	0.63 in	2.52 in	0.94 in	15800 lb	200 ft	4.8	680 lb



## Grade 80, Cam-Alloy Chain

- Specifically Recommended for Overhead Lifting Applications
- Standard Material: Alloy Steel, Heat Treated
- Standard Finish: Bright
- Hallmarking: “C8”, “USA” and Traceability Code
- Proof Tested
- Design Factor: 4 to 1
- Packaged in Drums, Order Unit is “Feet”
- Made in the USA
- DO NOT EXCEED THE WORKING LOAD LIMIT



Trade Size	Catalog No.	UPC No. 020418	Material Diameter	Inside Length	Inside Width	Working Load Limit	Feet Per Package	Links Per Foot	Weight Per Package
5/16 in	0400512	063367	0.32 in	0.94 in	0.46 in	4500 lb	500 ft	12.8	460 lb
1 in	0401612	063510	1.00 in	2.80 in	1.40 in	47700 lb	100 ft	4.3	965 lb
1-1/4 in	0402012	063534	1.25 in	3.50 in	1.75 in	72300 lb	60 ft	3.5	915 lb

## Grade 100, Cam-Alloy Chain

- Specifically Recommended for Overhead Lifting Applications
- 25% Stronger Than Grade 80 Which Enables You to Perform Same Lifts with Lighter Weight Chain
- Standard Material: Alloy Steel, Heat Treated
- Standard Finish: Bright
- Hallmarking: “C10”, “USA” and Traceability Code
- Proof Tested
- Design Factor: 4 to 1
- Packaged in Drums, Order Unit is “Feet”
- Made in the USA
- DO NOT EXCEED THE WORKING LOAD LIMIT



Trade Size	Catalog No.	UPC No. 020418	Material Diameter	Inside Length	Inside Width	Working Load Limit	Feet Per Package	Links Per Foot	Weight Per Package
9/32 in	0405212	182204	0.29 in	0.87 in	0.41 in	4300 lb	500 ft	13.8	370 lb
5/16 in	0405312	245510	0.33 in	1.01 in	0.50 in	5700 lb	500 ft	12	520 lb
3/8 in	0405412	182211	0.40 in	1.22 in	0.57 in	8800 lb	500 ft	10	740 lb
1/2 in	0405512	182228	0.52 in	1.58 in	0.75 in	15000 lb	300 ft	7.8	750 lb
5/8 in	0405612	182235	0.64 in	1.93 in	0.87 in	22600 lb	200 ft	6.5	758 lb
3/4 in	0405712	182242	0.80 in	2.42 in	1.09 in	35300 lb	100 ft	5.5	598 lb
7/8 in	0405812	152924	0.88 in	2.70 in	1.28 in	42700 lb	100 ft	4.4	775 lb



## Stainless Steel Chain



- Uses: Food Processing, Chemical and Marine Applications, Wherever Non-Magnetic, Electrically Welded Corrosion Resistant Chain is Needed
- Standard Material: Type 316L Stainless
- Standard Finish: Bright
- Hallmarking: "316"
- Proof Tested
- Design Factor: 4 to 1
- Cut to Order, Order Unit is "Feet"
- Do Not Use for Overhead Lifting
- DO NOT EXCEED THE WORKING LOAD LIMIT
- Working load limits (WLL) shown are room temperatures. Reduce WLL by 15% for temperatures up to 250°F, 25% between 250°F and 800°F, 33% between 800°F and 1000°F, 50% between 1000°F and 1200°F, and 60% between 1200°F and 1400°F.



Trade Size	Catalog No.	UPC No. 020418	Material Diameter	Inside Length	Inside Width	Working Load Limit	Links Per Foot	Weight Per 100 Feet (lbs)
5/32 in	0192411	177422	0.156 in	0.89 in	0.28 in	500 lb	15.6	21
3/16 in	0192711	176043	0.196 in	0.91 in	0.34 in	930 lb	13.2	41
1/4 in	0192911	176050	0.250 in	1.00 in	0.43 in	1570 lb	12	75
5/16 in	0193111	176067	0.312 in	1.03 in	0.49 in	2400 lb	11.7	95
3/8 in	0193311	176074	0.394 in	1.22 in	0.51 in	3550 lb	9.8	138

## Aluminum Chain



- Standard Material: 5056 Aluminum-Magnesium Alloy
- Standard Finish: Bright (Brt)
- Proof Tested
- Design Factor: 4 to 1
- Uses: Chemical Processing, Petroleum, Refining, Food Processing, Landscaping, Crowd Control, Wherever A Non-Magnetic, Non-Sparking Chain is Needed
- Cut to Order, Order Unit is "Feet"
- Made in the USA
- Do Not Use for Overhead Lifting or Dynamic Load Conditions
- DO NOT EXCEED THE WORKING LOAD LIMIT



Trade Size	Catalog No.	UPC No. 020418	Material Diameter	Inside Length	Inside Width	Working Load Limit	Links Per Foot	Weight Per 100 Feet (lbs)
17/64 in	0635211	176098	0.26 in	1.06 in	0.37 in	550 lb	11.3	19
5/16 in	0635311	176104	0.34 in	1.14 in	0.49 in	850 lb	10.5	36



## Straight Link Machine Chain - Cartons

- Uses: General Utility, Animal, and Farm and Ranch Applications
- Standard Material: Low Carbon Steel
- Standard Finish: Bright and Zinc Plated
- Proof Tested
- Design Factor: 4 to 1
- Packaged in Cartons, Order Unit is "Feet"
- Made in the USA
- Do Not Use for Overhead Lifting
- DO NOT EXCEED THE WORKING LOAD LIMIT



Trade Size	Bright		Zinc Plated		Material Diameter	Inside Length	Inside Width	Working Load Limit	Feet Per Package	Links Per Foot	Weight Per Package
	Catalog No.	UPC No. 020418	Catalog No.	UPC No. 020418							
1	—	—	0310124	060816	0.16 in	0.63 in	0.28 in	390 lb	100 ft	19.0	23 lb
1/0	—	—	0311024	060946	0.18 in	0.74 in	0.31 in	465 lb	100 ft	16.2	27 lb
2	—	—	0310224	060847	0.15 in	0.61 in	0.26 in	325 lb	100 ft	19.7	19 lb
2/0	0312014	060977	0312024	060984	0.18 in	0.78 in	0.34 in	545 lb	100 ft	15.4	29 lb
3	—	—	0310324	060878	0.14 in	0.59 in	0.24 in	270 lb	100 ft	20.3	15 lb
3/0	—	—	0313024	061011	0.21 in	1.01 in	0.36 in	635 lb	100 ft	11.9	37 lb
4	—	—	0310424	060908	0.12 in	0.55 in	0.21 in	215 lb	100 ft	21.8	11 lb
4/0	—	—	0314024	061042	0.23 in	1.03 in	0.38 in	700 lb	100 ft	11.7	47 lb
5/0	0315014	061073	0315024	061080	0.25 in	1.07 in	0.44 in	925 lb	100 ft	11.2	52 lb

## Straight Link Machine Chain - Reels

- Uses: General Utility, Animal, and Farm and Ranch Applications
- Standard Material: Low Carbon Steel
- Standard Finish: Zinc Plated and Brass Glo
- Proof Tested
- Design Factor: 4 to 1
- Packaged on Reels, Order Unit is "Each"
- Made in the USA
- Do Not Use for Overhead Lifting
- DO NOT EXCEED THE WORKING LOAD LIMIT



Trade Size	Catalog No.	UPC No. 020418	Material Diameter	Inside Length	Inside Width	Finish	Working Load Limit	Feet Per Package	Links Per Foot	Reel Width (in.)	Weight Per Package
4	AW0310427	145384	0.12 in	0.55 in	0.21 in	Zinc Plated	215 lb	100 ft	22	3.5 in	12 lb
3	0723367	064814	0.14 in	0.59 in	0.24 in	Brass Glo	270 lb	50 ft	20	3.5 in	9 lb
2	0726727	184475	0.15 in	0.61 in	0.26 in	Zinc Plated	325 lb	125 ft	19.7	10.75 in	26 lb



## Twist Link Machine Chain - Cartons

- Uses: General Utility Applications
- Standard Material: Low Carbon Steel
- Standard Finish: Bright, Zinc Plated and Galvanized
- Design Factor: 4 to 1
- Packaged in Cartons, Order Unit is "Feet"
- Made in the USA
- Do Not Use for Overhead Lifting
- DO NOT EXCEED THE WORKING LOAD LIMIT



Trade Size	Catalog No.	UPC No. 020418	Material Diameter	Inside Length	Inside Width	Finish	Working Load Limit	Feet Per Package	Links Per Foot	Weight Per Package
3	0320324	061165	0.14 in	0.56 in	0.20 in	Zinc Plated	255 lb	100 ft	21.4	16 lb
2	0320224	061134	0.15 in	0.58 in	0.21 in	Zinc Plated	310 lb	100 ft	20.7	20 lb
1/0	0321024	061219	0.18 in	0.68 in	0.26 in	Zinc Plated	440 lb	100 ft	17.6	28 lb
2/0	0322014	061233	0.18 in	0.73 in	0.28 in	Bright	520 lb	100 ft	16.4	31 lb
4/0	0324024	061301	0.23 in	0.89 in	0.32 in	Zinc Plated	670 lb	100 ft	13.5	48 lb
5/0	0325034	061349	0.25 in	1.00 in	0.37 in	Galvanized	880 lb	100 ft	12.0	56 lb

## Twist Link Machine Chain - Reels

- Uses: General Utility Applications
- Standard Material: Low Carbon Steel
- Standard Finish: Brass Glo and Zinc Plated
- Design Factor: 4 to 1
- Packaged on Reels, Order Unit is "Each"
- Made in the USA
- Do Not Use for Overhead Lifting
- DO NOT EXCEED THE WORKING LOAD LIMIT



Trade Size	Brass Glo		Zinc Plated		Material Diameter	Inside Length	Inside Width	Working Load Limit	Feet Per Package	Links Per Foot	Reel Width (in.)	Weight Per Package
	Catalog No.	UPC No. 020418	Catalog No.	UPC No. 020418								
2	0723388	064838	—	—	0.15 in	0.58 in	0.21 in	310 lb	70 ft	20.7	3.5 in	15 lb
2	—	—	0726627	184468	0.15 in	0.58 in	0.21 in	310 lb	125 ft	20.7	5.5 in	27 lb
2/0	—	—	0722527	183300	0.18 in	0.73 in	0.28 in	520 lb	70 ft	16.0	5.5 in	21 lb
4	—	—	AW0320427	145391	0.12 in	0.52 in	0.17 in	205 lb	100 ft	23.0	3.5 in	13 lb



CHAIN

## Twist Link Machine Chain - Round Pails

- Uses: General Utility Applications
- Standard Material: Low Carbon Steel
- Standard Finish: Zinc Plated
- Design Factor: 4 to 1
- Packaged in Pails, Order Unit is “Each”
- Made in the USA
- Do Not Use for Overhead Lifting
- DO NOT EXCEED THE WORKING LOAD LIMIT



Trade Size	Catalog No.	UPC No.	Material Diameter	Inside Length	Inside Width	Finish	Working Load Limit	Feet Per Package	Links Per Foot	Weight Per Package
2/0	0329500	169434	0.18 in	0.73 in	0.28 in	Zinc Plated	520 lb	300 ft	16.4	95 lb

## Twist Link Machine Chain - Square Pails

- Uses: General Utility Applications
- Standard Material: Low Carbon Steel
- Standard Finish: Zinc Plated
- Design Factor: 4 to 1
- Packaged in Pails, Order Unit is “Each”
- Made in the USA
- Do Not Use for Overhead Lifting
- DO NOT EXCEED THE WORKING LOAD LIMIT



Trade Size	Catalog No.	UPC No.	Material Diameter	Inside Length	Inside Width	Finish	Working Load Limit	Feet Per Package	Links Per Foot	Weight Per Package
2/0	0322026	183171	0.18 in	0.73 in	0.28 in	Zinc Plated	520 lb	175 ft	16.4	54 lb

## Straight Link Coil Chain - Cartons

- Typical Uses Include Tailgates, Barrier Guards, Swing Sets, Hanging Light Fixtures and Animal Chains
- Standard Material: Low Carbon Steel
- Standard Finish: Zinc Plated
- Proof Tested
- Design Factor: 4 to 1
- Packaged in Cartons, Order Unit is “Feet”
- Do Not Use for Overhead Lifting
- DO NOT EXCEED THE WORKING LOAD LIMIT



Trade Size	Catalog No.	UPC No.	Material Diameter	Inside Length	Inside Width	Finish	Working Load Limit	Feet Per Package	Links Per Foot	Weight Per Package
4	0330424	061455	0.12 in	1.11 in	0.21 in	Zinc Plated	205 lb	100 ft	10.8	10 lb
3	0330324	061424	0.14 in	1.17 in	0.24 in	Zinc Plated	255 lb	100 ft	10.3	13 lb
2	0330224	061394	0.15 in	1.18 in	0.26 in	Zinc Plated	310 lb	100 ft	10.2	15 lb
1	0330124	061363	0.16 in	1.25 in	0.28 in	Zinc Plated	370 lb	100 ft	9.6	19 lb
1/0	0331024	061516	0.18 in	1.25 in	0.31 in	Zinc Plated	440 lb	100 ft	9.6	22 lb
2/0	0332024	061578	0.18 in	1.29 in	0.34 in	Zinc Plated	520 lb	100 ft	9.3	24 lb
3/0	0333024	061622	0.21 in	1.30 in	0.36 in	Zinc Plated	605 lb	100 ft	9.2	31 lb
4/0	0334024	061660	0.22 in	1.39 in	0.42 in	Zinc Plated	670 lb	100 ft	8.6	35 lb
5/0	0335024	061721	0.234 in	1.52 in	0.44 in	Zinc Plated	880 lb	100 ft	7.9	41 lb





## Straight Link Coil Chain - Reels



- Typical Uses Include Tailgates, Barrier Guards, Swing Sets, Hanging Light Fixtures and Animal Chains
- Standard Material: Low Carbon Steel
- Standard Finish: Zinc Plated and Yellow Polycoated
- Proof Tested
- Design Factor: 4 to 1
- Packaged on Reels, Order Unit is "Each"
- Made in the USA
- Do Not Use for Overhead Lifting
- DO NOT EXCEED THE WORKING LOAD LIMIT



Trade Size	Zinc Plated		Yellow Polycoat		Material Diameter	Inside Length	Inside Width	Working Load Limit	Feet Per Package	Links Per Foot	Reel Width (in.)	Weight Per Package
	Catalog No.	UPC No. 020418	Catalog No.	UPC No. 020418								
4	AW0330427	145445	—	—	0.12 in	1.11 in	0.21 in	205 lb	100 ft	10.8	3.5 in	11 lb
2	0726827	184482	—	—	0.15 in	1.18 in	0.26 in	310 lb	125 ft	10.2	10.75 in	21 lb
2/0	0722827	183843	—	—	0.18 in	1.29 in	0.34 in	520 lb	40 ft	9.3	3.5 in	14 lb
2/0	0723627	064869	—	—	0.18 in	1.29 in	0.34 in	520 lb	125 ft	9.3	10.75 in	37 lb
2/0	—	—	PD0722627	183409	0.18 in	1.29 in	0.34 in	520 lb	120 ft	9.3	10.75 in	35 lb
3/0	0724527	175732	—	—	0.21 in	1.30 in	0.36 in	605 lb	100 ft	9.2	10.75 in	31 lb

## Straight Link Coil Green Sleeve Chain - Reels

- Used as Swing Set Chain
- Standard Material: Low Carbon Steel
- Standard Finish: Zinc Plated With Green Sleeve
- Proof Tested
- Design Factor: 4 to 1
- Packaged on Reels, Order Unit is "Each"
- Do Not Use for Overhead Lifting
- DO NOT EXCEED THE WORKING LOAD LIMIT



Trade Size	Catalog No.	UPC No. 020418	Material Diameter	Inside Length	Inside Width	Finish	Working Load Limit	Feet Per Package	Links Per Foot	Reel Width (in.)	Weight Per Package
2/0	PS0332027	208997	0.19 in	1.30 in	0.30 in	Green Sleeve	520 lb	60 ft	9.3	10.75 in	21 lb



CHAIN

## Straight Link Coil Chain - Round Pails

- Typical Uses Include Tailgates, Barrier Guards, Swing Sets, Hanging Light Fixtures and Animal Chains
- Standard Material: Low Carbon Steel
- Standard Finish: Zinc Plated
- Proof Tested
- Design Factor: 4 to 1
- Packaged in Pails, Order Unit is "Each"
- Made in the USA
- Do Not Use for Overhead Lifting
- DO NOT EXCEED THE WORKING LOAD LIMIT



Trade Size	Catalog No.	UPC No.	Material Diameter	Inside Length	Inside Width	Finish	Working Load Limit	Feet Per Package	Links Per Foot	Weight Per Package
2/0	0332023	061561	0.18 in	1.29 in	0.34 in	Zinc Plated	520 lb	400 ft	9.3	97 lb

## Straight Link Coil Chain - Square Pails

- Typical Uses Include Tailgates, Barrier Guards, Swing Sets, Hanging Light Fixtures and Animal Chains
- Standard Material: Low Carbon Steel
- Standard Finish: Zinc Plated
- Proof Tested
- Design Factor: 4 to 1
- Packaged in Pails, Order Unit is "Each"
- Made in the USA
- Do Not Use for Overhead Lifting
- DO NOT EXCEED THE WORKING LOAD LIMIT



Trade Size	Catalog No.	UPC No.	Material Diameter	Inside Length	Inside Width	Finish	Working Load Limit	Feet Per Package	Links Per Foot	Weight Per Package
1	0330126	187643	0.16 in	1.25 in	0.28 in	Zinc Plated	370 lb	350 ft	9.6	66 lb
1/0	0331026	187667	0.18 in	1.25 in	0.31 in	Zinc Plated	440 lb	250 ft	9.6	55 lb
2/0	0332426	183188	0.18 in	1.29 in	0.34 in	Zinc Plated	520 lb	225 ft	9.3	55 lb
5/0	0335026	187674	0.234 in	1.52 in	0.44 in	Zinc Plated	880 lb	140 ft	7.9	58 lb

## Studio Chain - Carton

- Uses: Hanging Theatrical Lights and Fixtures
- Standard Material: Low Carbon Steel
- Standard Finish: Bright
- Hallmarking: "CS" and "USA"
- Proof Tested
- Design Factor: 4 to 1
- Packaged in Cartons, Order Unit is "Feet"
- Made in the USA
- Do Not Use for Overhead Lifting



Trade Size	Catalog No.	UPC No.	Material Diameter	Inside Length	Inside Width	Finish	Working Load Limit	Feet Per Package	Links Per Foot	Weight Per Package
6/0	0336015	192876	0.28 in	1.50 in	0.47 in	Bright	2000 lb	100 ft	8	63 lb



## Twist Link Coil Chain - Cartons

- Typical Uses Include Tailgates, Barrier Guards, Light Fixtures and Animal Chains
- Difference Over Straight Link is Twist Link Chain Lies Flat
- Standard Material: Low Carbon Steel
- Standard Finish: Zinc Plated
- Design Factor: 4 to 1
- Packaged in Cartons, Order Unit is "Feet"
- Made in the USA
- Do Not Use for Overhead Lifting
- DO NOT EXCEED THE WORKING LOAD LIMIT



Trade Size	Catalog No.	UPC No.	Material Diameter	Inside Length	Inside Width	Finish	Working Load Limit	Feet Per Package	Links Per Foot	Weight Per Package
3	0340324	061868	0.14 in	1.14 in	0.21 in	Zinc Plated	240 lb	100 ft	10.5	13 lb

## Twist Link Coil Chain - Reels

- Typical Uses Include Tailgates, Barrier Guards, Light Fixtures and Animal Chains
- Difference Over Straight Link is Twist Link Chain Lies Flat
- Standard Material: Low Carbon Steel
- Standard Finish: Brass Glo
- Design Factor: 4 to 1
- Packaged on Reels, Order Unit is "Each"
- Made in the USA
- Do Not Use for Overhead Lifting
- DO NOT EXCEED THE WORKING LOAD LIMIT



Trade Size	Catalog No.	UPC No.	Material Diameter	Inside Length	Inside Width	Finish	Working Load Limit	Feet Per Package	Links Per Foot	Reel Width (in.)	Weight Per Package
3	0723167	064777	0.14 in	1.14 in	0.21 in	Brass Glo	240 lb	50 ft	10.5	3.5 in	7.5 lb

## Passing Link Chain - Cartons

- Uses: General Utility, Animal, and Farm and Ranch Applications
- Standard Material: Low Carbon Steel
- Standard Finish: Zinc Plated
- Proof Tested
- Design Factor: 4 to 1
- Packaged in Cartons, Order Unit is "Feet"
- Made in the USA
- Do Not Use for Overhead Lifting
- DO NOT EXCEED THE WORKING LOAD LIMIT



Trade Size	Catalog No.	UPC No.	Material Diameter	Inside Length	Inside Width	Finish	Working Load Limit	Feet Per Package	Links Per Foot	Weight Per Package
4/0	0304024	060786	0.22 in	0.88 in	0.50 in	Zinc Plated	600 lb	100 ft	13.8	43 lb



## Passing Link Chain - Reels

- Uses: General Utility, Animal, and Farm and Ranch Applications
- Standard Material: Low Carbon Steel
- Standard Finish: Zinc Plated
- Proof Tested
- Design Factor: 4 to 1
- Packaged on Reels, Order Unit is "Each"
- Made in the USA
- Do Not Use for Overhead Lifting
- DO NOT EXCEED THE WORKING LOAD LIMIT



Trade Size	Catalog No.	UPC No. 020418	Material Diameter	Inside Length	Inside Width	Finish	Working Load Limit	Feet Per Package	Links Per Foot	Reel Width (in.)	Weight Per Package
2/0	0722927	183317	0.18 in	0.88 in	0.47 in	Zinc Plated	450 lb	125 ft	13.75	10.75 in	36 lb
2/0	0722957	183478	0.18 in	0.88 in	0.47 in	Zinc Plated	450 lb	50 ft	13.75	5.5 in	15 lb

## Passing Link Chain - Square Pails

- Uses: General Utility, Animal, and Farm and Ranch Applications
- Standard Material: Low Carbon Steel
- Standard Finish: Zinc Plated
- Proof Tested
- Design Factor: 4 to 1
- Packaged in Pails, Order Unit is "Each"
- Made in the USA
- Do Not Use for Overhead Lifting
- DO NOT EXCEED THE WORKING LOAD LIMIT



Trade Size	Catalog No.	UPC No. 020418	Material Diameter	Inside Length	Inside Width	Finish	Working Load Limit	Feet Per Package	Links Per Foot	Weight Per Package
2/0	0309526	183164	0.18 in	0.88 in	0.47 in	Zinc Plated	450 lb	200 ft	13.8	58 lb

## Handy Link Utility Chain - Square Pails

- For Hanging Fixtures and Plants
- Standard Material: Low Carbon Steel
- Standard Finish: Zinc Plated
- Proof Tested
- Design Factor: 4 to 1
- Packaged in Pails, Order Unit is "Each"
- Made in the USA
- Do Not Use for Overhead Lifting
- DO NOT EXCEED THE WORKING LOAD LIMIT



Trade Size	Catalog No.	UPC No. 020418	Material Diameter	Inside Length	Inside Width	Finish	Working Load Limit	Feet Per Package	Links Per Foot	Weight Per Package
120	0339626	183195	0.120 in	1.35 in	0.34 in	Zinc Plated	255 lb	500 ft	8.9	50 lb



## Handy Link Utility Chain - Reels

- For Hanging Fixtures and Plants
- Standard Material: Low Carbon Steel
- Standard Finish: Zinc Plated
- Proof Tested
- Design Factor: 4 to 1
- Packaged on Reels, Order Unit is "Each"
- Made in the USA
- Do Not Use for Overhead Lifting
- DO NOT EXCEED THE WORKING LOAD LIMIT



Trade Size	Catalog No.	UPC No. 020418	Material Diameter	Inside Length	Inside Width	Finish	Working Load Limit	Feet Per Package	Links Per Foot	Reel Width (in.)	Weight Per Package
120	0723169	064784	0.120 in	1.35 in	0.34 in	Zinc Plated	255 lb	175 ft	8.9	10.75 in	17.5 lb

## Lock Link, Single Loop Chain - Cartons

- Ideal for Sprocket Wheel, Overhead Door Chains, General Utility Use
- Standard Material: Low Carbon Steel
- Standard Finish: Zinc Plated, Galvanized
- Design Factor: 4 to 1
- Packaged in Cartons, Order Unit is "Feet"
- Made in the USA
- Do Not Use for Overhead Lifting
- DO NOT EXCEED THE WORKING LOAD LIMIT



Trade Size	Zinc Plated			Galvanized			End Type	Working Load Limit	Feet Per Package	Links Per Foot	Weight Per Package
	Catalog No.	UPC No. 020418	Catalog No.	UPC No. 020418	Material Diameter	Inside Length					
1/0	0741024	066290	0741034	066320	0.12 in	1.29 in	Wrapped	265 lb	100 ft	9.3	16 lb
2	0740224	066238	0740234	066252	0.09 in	1.08 in	Sheared	155 lb	100 ft	11.1	9 lb
2/0	0742024	066375	0742034	066399	0.14 in	1.48 in	Wrapped	340 lb	100 ft	8.1	23 lb
3/0	0743024	066412	—	—	0.15 in	1.63 in	Wrapped	405 lb	100 ft	7.4	26 lb
4/0	0744024	066481	—	—	0.16 in	1.80 in	Wrapped	485 lb	100 ft	6.7	29 lb
5/0	0745024	066566	—	—	0.18 in	2.15 in	Wrapped	580 lb	100 ft	5.6	34 lb



## Lock Link, Single Loop Chain - Reels

- Ideal for Sprocket Wheel, Overhead Door Chains, General Utility Use
- Standard Material: Low Carbon Steel
- Standard Finish: Zinc Plated, Galvanized
- Design Factor: 4 to 1
- Packaged on Reels, Order Unit is “Each”
- Made in the USA
- Do Not Use for Overhead Lifting
- DO NOT EXCEED THE WORKING LOAD LIMIT



Trade Size	Zinc Plated		Galvanized		Material Diameter	Inside Length	End Type	Working Load Limit	Feet Per Package	Links Per Foot	Reel Width (in.)	Weight Per Package
	Catalog No.	UPC No. 020418	Catalog No.	UPC No. 020418								
1/0	—	—	<b>0741037</b>	066337	0.12 in	1.29 in	Wrapped	265 lb	250 ft	9.3	10.75 in	40 lb
2	—	—	<b>0740237</b>	066269	0.09 in	1.08 in	Sheared	155 lb	360 ft	11.1	10.75 in	33 lb
3/0	<b>0723427</b>	064845	—	—	0.15 in	1.63 in	Wrapped	405 lb	125 ft	7.4	10.75 in	33 lb
3/0	<b>0722427</b>	183454	—	—	0.15 in	1.63 in	Wrapped	405 lb	50 ft	7.4	5.5 in	17 lb
4/0	<b>0744027</b>	066498	<b>0744037</b>	066528	0.16 in	1.80 in	Wrapped	485 lb	100 ft	6.7	10.75 in	29 lb
5/0	—	—	<b>0745037</b>	066603	0.18 in	2.15 in	Wrapped	580 lb	100 ft	5.6	10.75 in	34 lb

## Brass Plumber’s Chain - Cartons

- Plumbing Fixtures, & Other Applications Requiring Light Flat Metal Chain
- Standard Material: Brass
- Standard Finish: Bright
- Design Factor: 4 to 1
- Packaged in Cartons, Order Unit is “Feet”
- Made in the USA
- Do Not Use for Overhead Lifting
- DO NOT EXCEED THE WORKING LOAD LIMIT



Trade Size	Catalog No.	UPC No. 020418	Stock Thickness (in)	Inside Length	Finish	Working Load Limit	Feet Per Package	Links Per Foot	Weight Per Package
2/0	<b>0872014</b>	067877	0.02 in	0.55 in	Bright	23 lb	100 ft	21.8	2 lb
1/0	<b>0871014</b>	067839	0.02 in	0.55 in	Bright	35 lb	100 ft	21.8	2 lb



## Brass Plumber's Chain - Reels



- Plumbing Fixtures, & Other Applications Requiring Light Flat Metal Chain
- Standard Material: Brass
- Standard Finish: Bright
- Design Factor: 4 to 1
- Packaged on Reels, Order Unit is "Each"
- Made in the USA
- Do Not Use for Overhead Lifting
- DO NOT EXCEED THE WORKING LOAD LIMIT



Trade Size	Catalog No.	UPC No. 020418	Stock Thickness (in)	Inside Length	Finish	Working Load Limit	Feet Per Package	Links Per Foot	Reel Width (in.)	Weight Per Package
1/0	0723817	064883	0.02 in	0.55 in	Bright	35 lb	200 ft	21.8	3.5 in	5 lb

## Inco, Double Loop Chain - Cartons



- Farm and Animal Chains, and Many General-Purpose Applications
- Standard Material: Low Carbon Steel
- Standard Finish: Zinc Plated, Galvanized
- Design Factor: 4 to 1
- Packaged in Cartons, Order Unit is "Feet"
- Made in the USA
- Note: Avoid Twisting in Suspension Applications
- Campbell Recommends The Use of Proof Coil or Straight Link Coil Chain for Swing Set Applications
- Do Not Use for Overhead Lifting
- DO NOT EXCEED THE WORKING LOAD LIMIT



Trade Size	Zinc Plated		Galvanized		Material Diameter	Inside Length	Working Load Limit	Feet Per Package	Links Per Foot	Weight Per Package	Shelf Pack
	Catalog No.	UPC No. 020418	Catalog No.	UPC No. 020418							
1	0750124	066641	—	—	0.11 in	1.54 in	155 lb	100 ft	7.8	10 lb	-
1/0	—	—	0751034	066924	0.12 in	1.78 in	200 lb	100 ft	6.7	13 lb	-
2	0750224	066696	—	—	0.09 in	1.33 in	115 lb	100 ft	9.0	8 lb	-
2/0	0752024	066979	0752034	067006	0.14 in	2.17 in	255 lb	100 ft	5.5	16 lb	-
3	0750324	066764	—	—	0.08 in	1.10 in	90 lb	100 ft	10.9	6 lb	100
4	0750424	066818	—	—	0.07 in	1.00 in	70 lb	100 ft	12.0	5 lb	100
4/0	—	—	0754034	067105	0.16 in	2.19 in	365 lb	100 ft	5.5	25 lb	-
8/0	—	—	0758034	067167	0.23 in	2.90 in	705 lb	100 ft	4.1	51 lb	-



## Inco, Double Loop Chain - Square Pails

- Farm and Animal Chains, and Many General-Purpose Applications
- Standard Material: Low Carbon Steel
- Standard Finish: Zinc Plated, Polycoated in White or Yellow Color
- Design Factor: 4 to 1
- Packaged in Pails, Order Unit is “Each”
- Made in the USA
- Note: Avoid Twisting in Suspension Applications
- Campbell Recommends The Use of Proof Coil or Straight Link Coil Chain for Swing Set Applications
- Do Not Use for Overhead Lifting
- DO NOT EXCEED THE WORKING LOAD LIMIT



Trade Size	Catalog No.	UPC No. 020418	Material Diameter	Inside Length	Finish	Working Load Limit	Feet Per Package	Links Per Foot	Weight Per Package
3	0754326	183348	0.08 in	1.10 in	Zinc Plated	90 lb	750 ft	10.9	47 lb
1	0754126	183331	0.11 in	1.54 in	Zinc Plated	155 lb	450 ft	7.8	45 lb
2/0	0752426	183324	0.14 in	2.17 in	Zinc Plated	255 lb	275 ft	5.5	50 lb
2/0	PD0752496	183584	0.14 in	2.17 in	Yellow Polycoat	255 lb	200 ft	5.5	36 lb

## Inco, Double Loop Chain - Round Pails

- Farm and Animal Chains, and Many General-Purpose Applications
- Standard Material: Low Carbon Steel
- Standard Finish: Zinc Plated
- Design Factor: 4 to 1
- Packaged in Pails, Order Unit is “Each”
- Made in the USA
- Note: Avoid Twisting in Suspension Applications
- Campbell Recommends The Use of Proof Coil or Straight Link Coil Chain for Swing Set Applications
- Do Not Use for Overhead Lifting
- DO NOT EXCEED THE WORKING LOAD LIMIT



Trade Size	Catalog No.	UPC No. 020418	Material Diameter	Inside Length	Finish	Working Load Limit	Feet Per Package	Links Per Foot	Weight Per Package
2/0	0752023	066962	0.14 in	2.17 in	Zinc Plated	255 lb	350 ft	5.5	56 lb

## Special Inco Well Chain

- General Utility; Farm and Animal; Well Pipes
- Standard Material: Low Carbon Steel, Galvanized Wire
- Packaged in Cartons, Order Unit is “Feet” or Pail, Order Unit is “Each”
- Made in the USA
- Do Not Use for Overhead Lifting
- DO NOT EXCEED THE WORKING LOAD LIMIT



Trade Size	Catalog No.	UPC No. 020418	Material Diameter	Inside Length	Finish	Working Load Limit	Feet Per Package	Links Per Foot	Weight Per Package
2/0	0762024	067174	0.14 in	2.50 in	Zinc Coated	255 lb	250 ft	5.5	41 lb
2/0	T0762026	237843	0.14 in	2.50 in	Zinc Coated	255 lb	250 ft	5.5	41 lb







## Inco, Double Loop Chain - Reels

- Farm and Animal Chains, and Many General-Purpose Applications
- Standard Material: Low Carbon Steel
- Standard Finish: Zinc Plated, Polycoated in White, Yellow, Green or Red Colors
- Design Factor: 4 to 1
- Packaged on Reels, Order Unit is "Each"
- Made in the USA
- Note: Avoid Twisting in Suspension Applications
- Campbell Recommends The Use of Proof Coil or Straight Link Coil Chain for Swing Set Applications
- Do Not Use for Overhead Lifting
- DO NOT EXCEED THE WORKING LOAD LIMIT



Trade Size	Catalog No.	UPC No. 020418	Material Diameter	Inside Length	Finish	Working Load Limit	Feet Per Package	Links Per Foot	Reel Width (in.)	Weight Per Package
4	0720427	064593	0.07 in	1.00 in	Zinc Plated	70 lb	500 ft	12.0	10.75 in	24 lb
3	0723227	064791	0.08 in	1.10 in	Zinc Plated	90 lb	200 ft	10.9	5.5 in	14 lb
3	LPA0722227	228902	.08 in	1.1 in	White Polycoat	90 lb	80 ft	10.9	3.5 in	6 lb
3	PG0722227	183423	0.08 in	1.10 in	Red Polycoat	90 lb	150 ft	10.9	5.5 in	11 lb
2	0750227	066702	0.09 in	1.33 in	Zinc Plated	115 lb	250 ft	9.0	10.75 in	21 lb
1	0720127	064579	0.11 in	1.54 in	Zinc Plated	155 lb	250 ft	7.8	10.75 in	25 lb
1	0722627	183461	0.11 in	1.54 in	Zinc Plated	155 lb	125 ft	7.8	5.5 in	14 lb
1/0	AW0751024	145612	0.12 in	1.78 in	Zinc Plated	200 lb	100 ft	6.7	5.5 in	13 lb
2/0	PA0722027	183355	0.14 in	2.17 in	White Polycoat	255 lb	125 ft	5.5	10.75 in	22 lb
2/0	PD0722027	183386	0.14 in	2.17 in	Yellow Polycoat	255 lb	125 ft	5.5	10.75 in	23 lb
2/0	PE0722027	183416	0.14 in	2.17 in	Green Polycoat	255 lb	125 ft	5.5	10.75 in	22 lb
2/0	0722027	183263	0.14 in	2.17 in	Zinc Plated	255 lb	155 ft	5.5	10.75 in	26 lb
2/0	0722087	183836	0.14 in	2.17 in	Zinc Plated	255 lb	60 ft	5.5	5.5 in	11 lb
2/0	PD0722087	183577	0.14 in	2.17 in	Yellow Polycoat	255 lb	50 ft	5.5	5.5 in	10 lb
3/0	0726427	184444	0.15 in	2.17 in	Zinc Plated	305 lb	150 ft	5.5	10.75 in	34 lb
4/0	0724627	209253	0.16 in	2.19 in	Zinc Plated	365 lb	100 ft	5.5	10.75 in	28 lb

## Single Jack Chain - Cartons

- Fixture and Novelty Suspension
- General Utility Use Not Requiring High Strength
- Standard Material: Low Carbon Steel
- Standard Finish: Zinc Plated
- Packaged in Cartons, Order Unit is "Feet"
- Made in the USA
- Do Not Use for Overhead Lifting
- DO NOT EXCEED THE WORKING LOAD LIMIT



Trade Size	Catalog No.	UPC No. 020418	Material Diameter	Inside Length	Finish	Working Load Limit	Feet Per Package	Links Per Foot	Weight Per Package
16	0801624	067402	0.06 in	0.50 in	Zinc Plated	10 lb	100 ft	24	3 lb
14	0801424	067365	0.08 in	0.63 in	Zinc Plated	16 lb	100 ft	19	5 lb
12	0801224	067327	0.11 in	0.75 in	Zinc Plated	29 lb	100 ft	16	9 lb
10	0801024	067280	0.14 in	0.93 in	Zinc Plated	43 lb	100 ft	13	14 lb
8	0800824	067235	0.16 in	1.09 in	Zinc Plated	60 lb	100 ft	11	21 lb



## Single Jack Chain - Reels

- Fixture and Novelty Suspension
- General Utility Use Not Requiring High Strength
- Standard Material: Low Carbon Steel
- Standard Finish: Zinc Plated, Brass Glo and Black Polycoated
- Packaged on Reels, Order Unit is “Each”
- Made in the USA
- Do Not Use for Overhead Lifting
- DO NOT EXCEED THE WORKING LOAD LIMIT



Trade Size	Catalog No.	UPC No. 020418	Material Diameter	Inside Length	Finish	Working Load Limit	Feet Per Package	Links Per Foot	Reel Width (in.)	Weight Per Package
16	0724027	064920	0.06 in	0.50 in	Zinc Plated	10 lb	250 ft	24	3.5 in	8 lb
14	PB0722827	183379	0.08 in	0.63 in	Black Polycoat	16 lb	190 ft	19	3.5 in	10 lb
14	AW0801427	145698	0.08 in	0.63 in	Zinc Plated	16 lb	200 ft	19	3.5 in	12 lb
12	0721727	064746	0.11 in	0.75 in	Zinc Plated	29 lb	100 ft	16	3.5 in	9 lb
12	AW0801227	145681	0.11 in	0.75 in	Zinc Plated	29 lb	200 ft	16	5.5 in	17 lb
10	AW0801027	145674	0.14 in	0.93 in	Zinc Plated	43 lb	100 ft	13	5.5 in	15 lb

## Double Jack Chain - Reels

- Fixture and Novelty Suspension
- General Utility Use Not Requiring High Strength
- Standard Material: Low Carbon Steel
- Standard Finish: Zinc Plated, Brass Glo
- Packaged on Reels, Order Unit is “Each”
- Made in the USA
- Do Not Use for Overhead Lifting
- DO NOT EXCEED THE WORKING LOAD LIMIT



Trade Size	Zinc Plated		Brass Glo		Material Diameter	Inside Length	Working Load Limit	Feet Per Package	Links Per Foot	Reel Width (in.)	Weight Per Package	Shelf Pack
	Catalog No.	UPC No. 020418	Catalog No.	UPC No. 020418								
16	0721627	064722	—	—	0.06 in	0.34 in	11 lb	200 ft	35	3.5 in	9 lb	1
16	—	—	0721667	064739	0.06 in	0.34 in	11 lb	200 ft	35	3.5 in	9 lb	-



## Sash Chain - Reels

- Counter-Balance Chain for Double Hung Window Sashes
- Also for Arc Lamp Chain, Animal Chain
- Standard Material: Low Carbon Steel
- Standard Finish: Zinc Plated
- Design Factor: 4 to 1
- Packaged on Reels, Order Unit is "Each"
- Made in the USA
- Do Not Use for Overhead Lifting
- DO NOT EXCEED THE WORKING LOAD LIMIT



Trade Size	Catalog No.	UPC No. 020418	Stock Thickness (in)	Inside Length	Finish	Working Load Limit	Feet Per Package	Links Per Foot	Reel Width (in.)	Weight Per Package
8	0890827	067969	0.04 in	0.55 in	Zinc Plated	75 lb	500 ft	22	5.5 in	20 lb
25	0892527	068041	0.04 in	0.55 in	Zinc Plated	94 lb	500 ft	22	10.75 in	25 lb
35	0893527	068218	0.04 in	0.59 in	Zinc Plated	106 lb	500 ft	20	10.75 in	30 lb
35	0723727	064876	0.04 in	0.59 in	Zinc Plated	106 lb	100 ft	20	3.5 in	7 lb

## Sash Chain - Cartons

- Counter-Balance Chain for Double Hung Window Sashes
- Also for Arc Lamp Chain, Animal Chain
- Standard Material: Low Carbon Steel
- Standard Finish: Zinc Plated, Copper Glo, Solid Bronze
- Design Factor: 4 to 1
- Packaged in Cartons, Order Unit is "Feet"
- Made in the USA
- Do Not Use for Overhead Lifting
- DO NOT EXCEED THE WORKING LOAD LIMIT



Trade Size	Zinc Plated		Copper Glo		Solid Bronze		Stock Thickness (in)	Inside Length	Working Load Limit	Feet Per Package	Links Per Foot	Weight Per Package	Shelf Pack
	Catalog No.	UPC No. 020418	Catalog No.	UPC No. 020418	Catalog No.	UPC No. 020418							
8	0890824	067952	0890844	067976	—	—	0.04 in	0.55 in	75 lb	100 ft	22	4 lb	100
8	—	—	0880844*	067921	—	—	0.04 in	0.55 in	75 lb	100 ft	22	4 lb	1
25	0892524	068034	—	—	—	—	0.04 in	0.55 in	94 lb	100 ft	22	5 lb	100
35	0893524	068201	0893544	068225	—	—	0.04 in	0.59 in	106 lb	100 ft	20	6 lb	-
35	—	—	—	—	0893574	068249	0.04 in	0.59 in	100 lb	100 ft	20	6 lb	-
40	0894024	068287	0894044	068300	—	—	0.04 in	0.59 in	131 lb	100 ft	20	7 lb	-
40	—	—	—	—	0894074	068324	0.04 in	0.59 in	125 lb	100 ft	20	7 lb	-
50	0895024	068454	—	—	—	—	0.06 in	0.65 in	225 lb	100 ft	21	11 lb	-

\* Includes fixtures for 7 double hung sashes. Order unit is box.



CHAIN

## Stainless Steel Sash Chain - Cartons

- Counter-Balance Chain for Double Hung Window Sashes
- Also for Arc Lamp Chain, Animal Chain
- Standard Material: Type 304 Stainless Steel
- Standard Finish: Polished
- Design Factor: 4 to 1
- Packaged in Cartons, Order Unit is "Feet"
- Made in the USA
- Do Not Use for Overhead Lifting
- Size 35 is also known as size 3 Navy chain
- DO NOT EXCEED THE WORKING LOAD LIMIT



Trade Size	Catalog No.	UPC No. 020418	Stock Thickness (in)	Inside Length	Finish	Working Load Limit	Feet Per Package	Links Per Foot	Weight Per Package
8	0898014	068560	0.04 in	0.55 in	Stainless Steel	75 lb	100 ft	22	4 lb
35	0895314	068515	0.04 in	0.59 in	Stainless Steel	175 lb	100 ft	20	6 lb

## Decorator Chain

- For Hanging Plants and Lamps, Drapery Tie-Backs
- Finishes: Zinc Plated, Brass Glo, Black Polycoated, Antique Brass, White Polycoated, Antique Copper, Antique Silver, Brushed Nickel
- Order Unit is "Each Reel"
- DO NOT EXCEED THE WORKING LOAD LIMIT



Trade Size	Catalog No.	UPC No. 020418	Material Diameter	Inside Length	Inside Width	Finish	Working Load Limit	Feet Per Package	Reel Width (in.)	Weight Per Package
4	0720428	178771	0.120 in	0.58 in	0.21 in	Zinc Plated	70 lb	90 ft	3.5 in	10 lb
10	0722000	190834	0.135 in	1.21 in	0.52 in	Brass Glo	35 lb	60 ft	3.5 in	10 lb
10	0722002	183218	0.135 in	1.21 in	0.52 in	Black Polycoat	35 lb	40 ft	3.5 in	6.8 lb
10	0722003	183225	0.135 in	1.21 in	0.52 in	Antique Brass	35 lb	40 ft	3.5 in	6.8 lb
10	0722004	183232	0.135 in	1.24 in	0.52 in	White Polycoat	35 lb	40 ft	3.5 in	6.8 lb
10	0722006	183249	0.135 in	1.21 in	0.52 in	Antique Copper	35 lb	40 ft	3.5 in	6.8 lb
10	0722007	183256	0.135 in	1.21 in	0.52 in	Antique Silver	35 lb	40 ft	3.5 in	6.8 lb
10	0722010	212161	0.135 in	1.21 in	0.52 in	Brushed Nickel	35 lb	40 ft	3.5 in	6.8 lb

## Hobby/Craft Decorator Chain - Standard Reels

- Used for Decorative and Hobby/Craft Applications
- Finishes: Brass Plated, Black
- Order Unit is "Each Reel"
- DO NOT EXCEED THE WORKING LOAD LIMIT



Trade Size	Brass Plated			Black			Working Load Limit	Feet Per Package	Reel Width (in.)	Weight Per Package	
	Catalog No.	UPC No. 020418	Catalog No.	UPC No. 020418	Material Diameter	Inside Length					Inside Width
100	0711017	188251	0711077	188268	0.087 in	0.63 in	0.24 in	13 lb	197 ft	4.5 in	11.6 lb



## Hobby/Craft Cathedral Chain - Standard Reels

- Used for Decorative and Hobby/Craft Applications
- Finishes: Brass Plated, Black, White
- Order Unit is "Each Reel"
- DO NOT EXCEED THE WORKING LOAD LIMIT



Trade Size	Brass Plated		Black		White		Material Diameter	Inside Length	Inside Width	Working Load Limit	Feet Per Package	Reel Width (in.)	Weight Per Package
	Catalog No.	UPC No. 020418	Catalog No.	UPC No. 020418	Catalog No.	UPC No. 020418							
31	0713117	188374	0713177	188381	0713187	188398	0.087 in	0.95 in	0.40 in	20 lb	98 ft	4.5 in	7 lb
32	0713217	188411	0713277	188428	—	—	0.105 in	1.57 in	0.56 in	35 lb	66 ft	4.5 in	7 lb

## Hobby/Craft Twist Chain - Mini Reels

- Used for Decorative and Hobby/Craft Applications
- Finishes: Brass Plated, Nickel Plated, Black
- Order Unit is "Each Reel"
- DO NOT EXCEED THE WORKING LOAD LIMIT



Trade Size	Brass Plated		Nickel Plated		Black		Material Diameter	Inside Length	Inside Width	Working Load Limit	Feet Per Package	Reel Width (in.)	Weight Per Package
	Catalog No.	UPC No. 020418	Catalog No.	UPC No. 020418	Catalog No.	UPC No. 020418							
70	0717017	188558	—	—	—	—	0.043 in	0.14 in	0.07 in	5 lb	82 ft	3.25 in	1.5 lb
90	0719017	188572	0719027	188589	—	—	0.056 in	0.21 in	0.12 in	5 lb	82 ft	3.25 in	2 lb
200	0712017	188282	—	—	—	—	0.079 in	0.40 in	0.16 in	12 lb	49 ft	3.25 in	2.8 lb
250	0712517	188312	—	—	0712577	188336	0.099 in	0.33 in	0.16 in	25 lb	33 ft	3.25 in	2.8 lb

## Hobby/Craft Clock Chain - Mini Reels

- Used for Decorative and Hobby/Craft Applications
- Finishes: Brass Plated
- Order Unit is "Each Reel"
- DO NOT EXCEED THE WORKING LOAD LIMIT



Trade Size	Catalog No.	UPC No. 020418	Material Diameter	Inside Length	Inside Width	Finish	Working Load Limit	Feet Per Package	Reel Width (in.)	Weight Per Package
3	0710317	188183	0.043 in	0.31 in	0.11 in	Brass Plated	5 lb	164 ft	3.25 in	2.8 lb
5	0710517	188206	0.051 in	0.31 in	0.11 in	Brass Plated	10 lb	82 ft	3.25 in	1.8 lb
7	0710717	188220	0.063 in	0.30 in	0.11 in	Brass Plated	15 lb	82 ft	3.25 in	2.5 lb

## Hobby/Craft Sash Chain - Mini Reels

- Used for Decorative and Hobby/Craft Applications
- Finishes: Chrome Plated
- Order Unit is "Each Reel"
- DO NOT EXCEED THE WORKING LOAD LIMIT



Trade Size	Catalog No.	UPC No. 020418	Material Diameter	Inside Length	Inside Width	Finish	Working Load Limit	Feet Per Package	Reel Width (in.)	Weight Per Package
2	0710227	188176	0.016 in	0.58 in	0.20 in	Chrome Plated	29 lb	164 ft	3.25 in	2.1 lb
3	0713027	188367	0.020 in	0.75 in	0.27 in	Chrome Plated	25 lb	82 ft	3.25 in	1.8 lb

## Hobby Chain - Carded

- Used for Decorative and Hobby/Craft Applications
- Finishes: Brass Plated, Nickel Plated, Black
- DO NOT EXCEED THE WORKING LOAD LIMIT

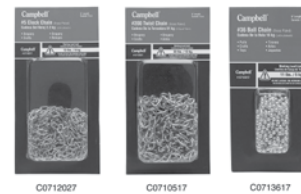

Trade Size	Brass Plated		Nickel Plated		Material Diameter	Chain Type	Working Load Limit	Feet Per Card	Weight Per Package	Shelf Pack
	Catalog No.	UPC No. 020418	Catalog No.	UPC No. 020418						
5	C0710517	212505	—	—	0.051 in	#5 Clock Chain	10 lb	15	0.39 lb	5
36	C0713617	212529	C0713627	212512	0.142 in	#36 Ball Chain w/2 connectors	11 lb	6	0.12 lb	5
200	C0712017	212543	C0712027	212536	0.079 in	#200 Twist Chain	12 lb	10	0.58 lb	5

## Ball Chain

- Used for Chain Pulls and Other Home and Craft Projects
- Ball Chain Connectors are packed 6 pcs per Bag and 10 Bags per Box
- DO NOT EXCEED THE WORKING LOAD LIMIT



Trade Size	Catalog No.	UPC No. 020418	Material Diameter	Chain Type	Finish	Working Load Limit	Feet Per Package	Reel Width (in.)	Weight Per Package	Shelf Pack
36	0713627	188459	0.142 in	#36 Ball Chain	Chrome Plated	11 lb	164 ft	3.25 in	2.60 lb	-
36	B0713601	156755	-	#36 Ball Chain Connector	Chrome Plated	-	-	-	-	10

## Oval Link Chain

- Used for Decorative and Hobby/Craft Applications
- Finishes: Brass Plated
- Order Unit is "Each Reel"
- DO NOT EXCEED THE WORKING LOAD LIMIT



Trade Size	Catalog No.	UPC No. 020418	Material Diameter	Inside Length	Inside Width	Finish	Working Load Limit	Feet Per Package	Reel Width (in.)	Weight Per Package
19	0711917	188275	0.043 in	0.20 in	0.11 in	Brass Plated	3 lb	82 ft	3.25 in	1.70 lb



## Plastic Chain - Square Pails

- Used for Creating Borders for Flower Beds, Gardens, Driveways, Etc.
- For Decorative Non-Load Bearing Use Only
- Available in Three Colors: White, Yellow or Black
- Order Unit is "Each Pail"
- Do Not Use for Overhead Lifting, Towing or Pulling



Trade Size	White		Yellow		Black		Material Diameter	Inside Length	Inside Width	Feet Per Package	Weight Per Package
	Catalog No.	UPC No. 020418	Catalog No.	UPC No. 020418	Catalog No.	UPC No. 020418					
6	0990646	185168	—	—	—	—	0.23 in	1.00 in	0.30 in	220 ft	16 lb
8	0990846	185205	0990836	185182	0990856	185229	0.29 in	1.50 in	0.40 in	138 ft	12 lb

## Plastic Chain - Reels

- Used for Creating Borders for Flower Beds, Gardens, Driveways, Etc.
- For Decorative Non-Load Bearing Use Only
- Available in Three Colors: White, Yellow or Black
- Order Unit is "Each Reel"
- Do Not Use for Overhead Lifting, Towing or Pulling



Trade Size	White		Yellow		Black		Material Diameter	Inside Length	Inside Width	Feet Per Package	Reel Width (in.)	Weight Per Package
	Catalog No.	UPC No. 020418	Catalog No.	UPC No. 020418	Catalog No.	UPC No. 020418						
6	0990647	185175	—	—	—	—	0.23 in	1.00 in	0.30 in	100 ft	10.75 in	7 lb
8	0990847	185212	0990837	185199	0990857	185236	0.30 in	1.50 in	0.50 in	60 ft	10.75 in	5 lb

## Cable - Uncoated, Galvanized

- High Strength Cable with A Galvanized Finish
- Flexible 7 X 7 or 7 X 19 Construction
- Design Factor: 5 to 1
- DO NOT EXCEED THE WORKING LOAD LIMIT

Catalog No.	UPC No. 020418	Size (in.)	Construction Type	Working Load Limit	Feet Per Package	Reel Width (in.)	Weight Per Package
7000227	100253	1/16	7 x 7	96 lb	500 ft	3.5 in	5 lb
7000327	100260	3/32	7 x 7	184 lb	500 ft	3.5 in	14 lb
7000427	100284	1/8	7 x 7	340 lb	500 ft	3.5 in	16 lb
7000627	100307	3/16	7 x 19	840 lb	250 ft	3.5 in	18 lb
7000827	100321	1/4	7 x 19	1400 lb	250 ft	6 in	26 lb
7000927	189463	5/16	7 x 19	1960 lb	200 ft	6 in	35 lb
7001027	289439	3/8	7 x 19	-	150 ft	-	35 lb



## Cable - Stainless Steel

- High Strength Stainless Steel Cable
- Type 304 Stainless Steel
- Flexible 7 X 7 or 7 X 19 Construction
- Design Factor: 5 to 1
- DO NOT EXCEED THE WORKING LOAD LIMIT

Catalog No.	UPC No. 020418	Size (in.)	Construction Type	Working Load Limit	Feet Per Package	Reel Width (in.)	Weight Per Package
T7000226	240775	1/16	7 x 7	96 lb	250 ft	3.5 in	2.3 lb
T7000326	240782	3/32	7 x 7	184 lb	250 ft	3.5 in	6.3 lb
7000426	193071	1/8	7 x 7	340 lb	250 ft	3.5 in	7.2 lb
7000626	193088	3/16	7 x 19	740 lb	250 ft	3.5 in	16 lb
7000826	193095	1/4	7 x 19	1280 lb	250 ft	6 in	26 lb
T7000926	238192	5/16	7 x 19	1800 lb	200 ft	6 in	35 lb

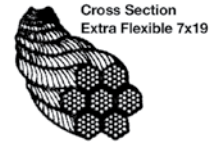

## Cable - Vinyl Coated

- High Strength Cable with A Galvanized Finish
- Clear Vinyl Coated
- Flexible 7 X 7 or 7 X 19 Construction
- Vinyl Coated Cable is More Resistant to Abrasion and Weathering
- Can Be Cleaned Easily
- Warning: Remove Plastic Coating From Cable Where Clips, Clamps, Ferrules or Hardware Are Attached
- Design Factor: 5 to 1
- DO NOT EXCEED THE WORKING LOAD LIMIT



Catalog No.	UPC No. 020418	Size (in.)	Size With Coating (in.)	Construction Type	Color	Working Load Limit	Feet Per Package	Reel Width (in.)	Weight Per Package
7000397	100277	3/32	1/8 in	7 x 7	Clear	184 lb	250 ft	3.5 in	8 lb
7000497	100291	1/8	3/16 in	7 x 7	Clear	340 lb	250 ft	3.5 in	10 lb
7000697	100314	3/16	1/4 in	7 x 19	Clear	840 lb	250 ft	6 in	20 lb
7000797	289309	3/16	1/4 in	7 x 19	Hi Viz Orange	840 lb	250 ft	6 in	20 lb
7000897	100338	1/4	5/16 in	7 x 19	Clear	1400 lb	200 ft	6 in	26 lb

## Cable - Coated Green

- Green Vinyl Coated Cable
- 1 X 7 Iron Wire Construction Which Enables Bending or Shaping of Cable
- Vinyl Coated Cable is More Resistant to Abrasion and Weathering
- Can Be Cleaned Easily
- Warning: Remove Plastic Coating From Cable Where Clips, Clamps, Ferrules or Hardware Are Attached
- Design Factor: 5 to 1
- DO NOT EXCEED THE WORKING LOAD LIMIT



Catalog No.	UPC No. 020418	Size (in.)	Size With Coating (in.)	Construction Type	Working Load Limit	Feet Per Package	Reel Width (in.)	Weight Per Package
7000197	189456	1/16	1/8 in	1 x 7	28 lb	250 ft	3.5 in	5 lb





## Wire Rope - Uncoated

- 6X19 Fiber Core Construction
- Treated with A Rust Prohibiting Oil
- Design Factor: 5 to 1
- DO NOT EXCEED THE WORKING LOAD LIMIT



Catalog No.	UPC No. 020418	Size (in.)	Construction Type	Working Load Limit	Feet Per Package	Reel Width (in.)	Weight Per Package
7008027	190902	1/4	6 x 19	1040 lb	500 ft	8.5 in	53 lb
7008227	190919	5/16	6 x 19	1700 lb	500 ft	8.5 in	82 lb
7008327	190926	3/8	6 x 19	2400 lb	250 ft	8.5 in	58 lb
7008427	190933	1/2	6 x 19	4280 lb	250 ft	9.75 in	102 lb

## Chain and Cable - Plastic Clam Shell Packs

- Product Packaged in Clear, See-Through Plastic Clam Shells
- Customer Can See Product First Hand
- Package Will Sit Upright on Shelf or Can Be Hung Using Convenient Hang Up Hole
- Do Not Use for Overhead Lifting
- DO NOT EXCEED THE WORKING LOAD LIMIT



Catalog No.	UPC No. 020418	Size and Description	Working Load Limit	Feet Per Package	Weight Per Package	Shelf Pack
5971230	185243	3/16" Proof Coil Chain, Zinc Plated	800 lb	10 ft	4 lb	6
5973000	185250	2/0 Passing Link Chain, Zinc Plated	450 lb	10 ft	3.4 lb	5
5973310	185274	2/0 Straight Link Coil Chain, Zinc Plated	520 lb	10 ft	3 lb	5
5977502	185304	#3 Double Loop (Inco) Chain, Zinc Plated	90 lb	15 ft	1 lb	9
5977510	185311	#1 Double Loop (Inco) Chain, Zinc Plated	155 lb	15 ft	1.7 lb	5
5977522	185335	2/0 Double Loop (Inco) Chain, Zinc Plated	255 lb	15 ft	2.6 lb	6
5978000	185342	#12 Single Jack Chain, Zinc Plated	29 lb	15 ft	1.4 lb	9
5979600	185403	#10 Decorator Chain, Brass Glo	35 lb	10 ft	1.4 lb	5
5979610	185410	#10 Decorator Chain, Black	35 lb	10 ft	1.6 lb	5
5979630	185434	#10 Decorator Chain, White	35 lb	10 ft	1.6 lb	5
5977001	185571	3/32" Vinyl Coated Cable	184 lb	50 ft	2 lb	5
5977011	185595	1/8" Vinyl Coated Cable	340 lb	50 ft	2 lb	5
5977020	185601	3/16" Vinyl Coated Cable	840 lb	25 ft	2.2 lb	5
5977206CBL	239540	3/16" x 6' Security Cable	840 lb	6 ft	.6 lb	3
5977405CBL	239557	1/8" x 50' Galvanized Cable w/Swaged Eye One End	340 lb	50 ft	1.5 lb	3
5977410CBL	239564	1/8" x 100' Galvanized Cable w/Swaged Eye One End	340 lb	100 ft	3 lb	3
5977610CBL	239571	1/8" x 100' Vinyl Coated Cable w/Swaged Eye One End	340 lb	100 ft	3.4 lb	3



## Construction Chain

- Manufactured Using Grade 30 Proof Coil Chain
- Self Colored Finish
- General Purpose Chain Primarily Used in Telecommunications Industry for Tying, Binding and Pulling; Outside the Plant
- Order unit is “Each”
- Do Not Use for Overhead Lifting
- DO NOT EXCEED THE WORKING LOAD LIMIT



Catalog No.	UPC No. 020418	Size/Trade Size	Weight Each	Working Load Limit
0213505	178405	5/16 in x 4-1/3 ft.	6 lb	1700 lb

## Winch Line Chains

- Made From Alloy Chain and Used with Wire Rope When Wrapping is Required to Lift, Pull or Skid
- Special Hook is Designed to Minimize Fraying of Wire Rope to Which It is Attached
- Proof Tested
- Bulk Packaged, Order Unit is “Each”
- Made in the USA
- DO NOT EXCEED THE WORKING LOAD LIMIT



Trade Size	Catalog No.	UPC No. 020418	Chain Length	Weight Each	Working Load Limit
3/4 in	2011295	068706	18 in	12 lb	23000 lb
7/8 in	2011495	068713	24 in	24 lb	34200 lb
1 in	2011695	068720	24 in	27 lb	38700 lb

## Log Chain

- Made From Grade 30 Proof Coil Chain with Grab Hook One End, Slip Hook Other End
- Standard Finish: Self Colored
- Proof Tested
- Design Factor: 4 to 1
- Packed One 14 Ft. Length Per Bag; 2 Bags Per Box
- Made in the USA
- Do Not Use for Overhead Lifting
- DO NOT EXCEED THE WORKING LOAD LIMIT



Trade Size	Catalog No.	UPC No. 020418	Length	Weight Each	Working Load Limit	Shelf Pack
3/8 in	1005505	068591	14 ft	23 lb	2650 lb	2



## Grade 43, Binder Chains, Packed in Pail or Vinyl Bag

- Binder Chains Manufactured Using Grade 43 Chain and Feature Forged Heat Treated Clevis Grab Hooks on Each End
- Standard Finish: Bright (Brt)
- Chains May Be Used in Accordance with the Latest D.O.T. Regulations
- Used to Tie Down or “Bind” Loads for Transportation
- Packaged in Pails or Bags, Order Unit is “Each”
- Made in the USA
- Do Not Use for Overhead Lifting
- DO NOT EXCEED THE WORKING LOAD LIMIT



Catalog No.	UPC No. 020418	Size/Trade Size	Packaging	Finish	Weight Each	Working Load Limit	Shelf Pack
T0222725	163067	3/8 in x 16 ft	1 per Bag	Bright	25 lb	5400 lb	-
T0223698	264368	3/8 in x 20 ft	1 per Bag	Bright	32 lb	5400 lb	-
T0223820	237829	3/8 in x 20 ft	3 per Pail	Bright	32 lb	5400 lb	3

## Grade 43, Binder Chains

- Binder Chains Manufactured Using Grade 43 Chain and Feature Forged Heat Treated Clevis Grab Hooks on Each End
- Standard Finish: Bright (Brt)
- Chains May Be Used in Accordance with the Latest D.O.T. Regulations
- Used to Tie Down or “Bind” Loads for Transportation
- Packaged in Drums, Order Unit is “Each”
- Made in the USA
- Do Not Use for Overhead Lifting
- DO NOT EXCEED THE WORKING LOAD LIMIT



Catalog No.	UPC No. 020418	Size/Trade Size	Pieces Per Package	Finish	Weight Each	Working Load Limit
0226615	059995	5/16 in x 20 ft	25	Bright	20 lb	3900 lb
0226625	060007	5/16 in x 25 ft	25	Bright	25 lb	3900 lb
0222525	174339	3/8 in x 12 ft	25	Bright	19 lb	5400 lb
0222625	174353	3/8 in x 14 ft	25	Bright	21 lb	5400 lb
0222725	174377	3/8 in x 16 ft	20	Bright	25 lb	5400 lb
0222925	174414	3/8 in x 20 ft	20	Bright	32 lb	5400 lb
0223025	174438	3/8 in x 25 ft	20	Bright	37 lb	5400 lb



## Grade 70, Binder Chains, Packed in Pail or Vinyl Bag

- Binder Chains Manufactured Using Grade 70 Chain and Feature Forged Heat Treated Clevis Grab Hooks on Each End
- Standard Finish: Chain Has Yellow Chromated Zinc Electroplate Finish, Hooks Are Bright Finish
- Chains May Be Used in Accordance with the Latest D.O.T. Regulations
- Packaged in Pails or Bags, Order Unit is “Each”
- Made in the USA
- Do Not Use for Overhead Lifting
- DO NOT EXCEED THE WORKING LOAD LIMIT



Catalog No.	UPC No. 020418	Size/Trade Size	Packaging	Finish	Weight Each	Working Load Limit	Shelf Pack
T0513598	263248	5/16 in x 20 ft	1 per Bag	Yellow Chromate	22 lb	4700 lb	2
T0513668	289361	5/16 in x 20 ft	3 per Pail	Yellow Chromate	66 lb	4700 lb	3
T0513698	262937	3/8 in x 20 ft	1 per Bag	Yellow Chromate	32 lb	6600 lb	1
T0513678	237782	3/8 in x 20 ft	3 per Pail	Yellow Chromate	96 lb	6600 lb	3

## Grade 70 Binder Chains

- Binder Chains Manufactured Using Grade 70 Chain and Feature Forged Heat Treated Clevis Grab Hooks on Each End
- Standard Finish: Chain Has Yellow Chromated Zinc Electroplate Finish, Hooks Are Bright Finish
- Chains May Be Used in Accordance with the Latest D.O.T. Regulations
- Grade 70 Binder Chains Provide Higher Load-To-Weight Ratios
- Used to Tie Down or “Bind” Loads for Transportation
- Packaged in Drums, Order Unit is “Each”
- Made in the USA
- Do Not Use for Overhead Lifting
- DO NOT EXCEED THE WORKING LOAD LIMIT



Catalog No.	UPC No. 020418	Size/Trade Size	Pieces Per Package	Finish	Weight Each	Working Load Limit
0513572	174179	5/16 in x 16 ft	25	Yellow Chromate	17 lb	4700 lb
0513574	174193	5/16 in x 20 ft (Short Link)	25	Yellow Chromate	24 lb	4700 lb
0513576	212130	5/16 in x 20 ft (Long Link)	25	Yellow Chromate	22 lb	4700 lb
0513575	174209	5/16 in x 25 ft	25	Yellow Chromate	30 lb	4700 lb
0513660	064135	3/8 in x 16 ft	25	Yellow Chromate	27 lb	6600 lb
0513665	064159	3/8 in x 20 ft	20	Yellow Chromate	32 lb	6600 lb
0513667	064166	3/8 in x 25 ft	20	Yellow Chromate	39 lb	6600 lb
0513765	178788	1/2 in x 20 ft	20	Yellow Chromate	54 lb	11300 lb



## Tow Chain

- Tow Chains Are Available in High Test or Transport Grade
- All Have Forged Clevis Hooks
- Tow Chains Are Subject to Shock Loading and Must Be Inspected Frequently
- They Must Be Taken Out of Service When Damaged
- Select the Right Chain for the Job According to the Working Load Limits
- Made in the USA
- Do Not Use for Overhead Lifting
- DO NOT EXCEED THE WORKING LOAD LIMIT

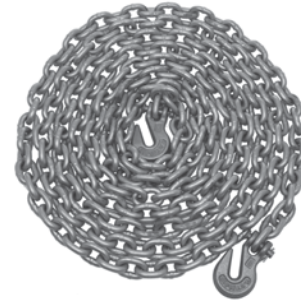

Catalog No.	UPC No. 020418	Size/Trade Size	Chain Type	Finish	Packaging	Weight Each	Working Load Limit	Shelf Pack
0231912	187681	5/16 in x 12 ft	High Test Chain w/Clevis Hooks	Hi-Visibility Orange Polycoat	1/Bag	14 lb	3900 lb	2
0231916	188756	5/16 in x 16 ft	High Test Chain w/Clevis Hooks	Hi-Visibility Orange Polycoat	1/Bag	18 lb	3900 lb	2
0513578	175794	5/16 in x 20 ft	Transport Chain w/Clevis Hooks	Yellow Chromate	1/Bag	22 lb	4700 lb	2

## Tow Cable

- Used for Towing, Logging
- Galvanized Cable with Zinc Plated Hooks
- Product Packaged in Clear, See-Through Plastic Clam Shells
- Eye Slip Hooks Swaged on Each End
- Do Not Use for Overhead Lifting
- DO NOT EXCEED THE WORKING LOAD LIMIT



Catalog No.	UPC No. 020418	Size and Description	Working Load Limit	Weight Each	Shelf Pack
5977920	205453	5/16 in x 20 ft	1960 lb	5 lb	3

## Pet Tie-Outs

- Product Packaged in Clear, See-Through Plastic Clam Shells
- One Chain or Cable Per Clam Shell
- Welded Pet Tie-Out Uses 2/0 Welded Chain with Heavy Duty Swivel Snaps Each End, Rated for Larger Pets Up to 70 Lbs.
- Tie-Out Cable Features Red Vinyl Coating Over Galvanized Cable with Swivel Snaps on Each End, Rated for Small to Medium Pets Up to 35 Lbs.



Catalog No.	UPC No. 020418	Size and Description	Chain/Cable Size	Length	Working Load Limit	Weight Per Package	Shelf Pack
3129907	211690	Large Pet Tie-out Chain w/Swivel Snaps Each End	2/0	15 ft	520 lb	3.6 lb	3
5970820	205378	Small to Medium Pet Tie-out Cable w/Swivel Snaps Each End	1/8"	20 ft	150 lb	1.2 lb	3

## Dog Runner and Kennel Chains

- Product Packaged in Clear, See-Through Plastic Clam Shells
- Inco Chain with Zinc Plate Finish and Swivel Snaps Each End
- One Chain Per Clam Shell
- For Small to Medium Pets Up to 35 Lbs.



Catalog No.	UPC No.	Chain/Cable Size	Length	Working Load Limit	Weight Per Package	Shelf Pack
3129504	171055	# 2	15 ft	80 lb	1.25 lb	5
3129507	171079	2/0	15 ft	120 lb	2.50 lb	6

## Tie-Out Chains

- Product Packaged in Clear, See-Through Plastic Clam Shells
- Double Loop (Inco) Chain with Ring and Swivel Snaps on Opposite Ends, Swivel in Center
- One Chain Per Clam Shell
- For Small to Medium Pets Up to 35 Lbs.



Catalog No.	UPC No.	Chain/Cable Size	Length	Working Load Limit	Weight Per Package	Shelf Pack
3209507	171109	2/0	20 ft	120 lb	3.25 lb	3

## Porch Swing Chain Assembly with Hooks

- For Securing Porch Swings to Porch Ceilings
- Set Packaged One Pair Per Clam Shell, Includes Hooks for Installation
- The Rated Working Load Limit is 500Lb / 227Kg Per Pair
- Made in the USA



Catalog No.	UPC No.	Working Load Limit	Weight Per Package	Shelf Pack
0702024	064562	500 lb	3.30 lb	5

## Hydraulic Chain Cutters

- 7508495 – Max capacity: 3/8" high test chain (G43)
- 7508595 – Max capacity: 3/8" alloy/transport (G70) or 1/2" high test chain (G43)
- Both can be mounted to Campbell free standing or Lozier display
- MADE IN USA



Catalog No.	UPC No.	Type	Capacity	Weight Each
7508495	135477	Hydraulic Chain Cutter	3/8 in	33 lb
7508595	178320	Hydraulic Chain Cutter # 80	3/8 in	38 lb
M7508494	208294	Hydraulic Cutter Guard Kit	-	1 lb

**ACCESSORIES**

Load Binders.....	48
Cable Pullers.....	48
“S” Hooks .....	49
Cold Shuts .....	49
Lap Links .....	50
Double Clevises .....	50
Hitch Pins.....	51
Clevises .....	52
Draw Bar Hooks.....	52
Welded Rings.....	54
Seven Seas Welded Rings .....	54
Seven Seas Net Links .....	54
Welded Rings (Imported) .....	55
Dees.....	55
Swivels .....	55
Tie-out Stake .....	56
Gate Hook .....	56
Iron and Steel Snaps .....	57
Die Cast Zinc Snaps .....	59
Bronze Snaps.....	60
Stainless Steel Snaps.....	61
Links (Snap and Quick).....	61
Pulleys .....	64
Rope Clamps.....	65
Rope Cleats.....	65
Footman Loops .....	66
Ferrules and Stops .....	66
Swaging Tool .....	66
Wire Rope Clips and Thimbles .....	67
Eye and Eye Swivels (Imported) .....	68
Shackles.....	68
Turnbuckles .....	68
Forged Turnbuckles .....	69
Grab Hooks and Slip Hooks .....	70



## Campbell® Accessories

Campbell began manufacturing harness hardware of malleable iron in 1873. Over the years, Campbell has added an extensive line of snaps made from malleable iron, steel, zinc, bronze, stainless steel, and aluminum. Campbell also offers a broad line of accessories to complement our chain and cable products, as well as products for use on synthetic webbing and rope.

## Warnings, Cautions, Inspection and Proper Use of Chain

Certain precautions and standards of treatment should be observed when using Campbell accessories. Proper care will extend the useful life of the product.

### SNAPS, PULLEYS, QUICK AND SPRING LINKS, RINGS AND SWIVELS

Campbell offers a full line of snap products made from a variety of materials to meet the needs of many applications. These products are designed and intended for light duty applications.

Typical and appropriate uses would include pet leashes, ancillary saddlery and tack, hanging plants, flagpoles, tarp covers, key rings, gate closures, luggage and shoulder bag straps. Snaps are not to be used for overhead lifting, to support human weight, for playground or athletic equipment, or as safety devices.

### WARNINGS AND CAUTIONS:

- The use of accessories is subject to certain hazards that cannot be met by mechanical or manufacturing means, but only by the exercise of intelligence, care and common sense.
- Do not exceed the working load limit of the accessory.
- Chemically active environments may adversely affect accessories. Do not use in highly acidic or caustic environments. Campbell should be contacted if the accessory will be exposed to chemically active environments during use.
- High and low temperatures will affect accessories. Campbell should be contacted if temperatures below -20°F (-29°C) or above 200°F (93°C) will be experienced.
- Accessories, such as load binders, used in certain applications are subject to governmental regulations. Please follow all Federal, State and/or Local Department of Transportation, OSHA, or other applicable standards and regulations when using Campbell products.
- Never field weld or repair accessories.
- See specific information under “Inspection” and “Proper Use” sections.

### INSPECTION

Regular inspections should be conducted on accessories to detect damage or deterioration from use. The accessory should be inspected for any of the below conditions. If present, the accessory should immediately be removed from service.

- Cracks.
- Excessive nicks or gouges.
- Excessive wear. The accessory should be removed from service if any dimension is worn more than 10% from the original dimension.
- Stretched, bent, twisted, or distorted parts.
- Excessive corrosion.
- Evidence of heat damage.
- Evidence of field welding.
- Any other condition which questions the integrity of the accessory.

### PROPER USE

To protect the users and to prevent damage to the accessories, the following safe practices should be followed:

- Select the accessory suitable for the application and environment.
- Avoid shock loading.
- Avoid bending over sharp edges or corners.
- Avoid twisting.
- Follow the assembly instructions and cautions and warning on the product packaging.

Purchasers please note that all “Warnings and Cautions” apply to accessories as well as all chain, components and fittings. Purchasers are responsible for conveying the “Warnings and Cautions” including the “Inspection” and “Proper Use” section information to the end user. Campbell denies any liability for damage that results from use in excess of the working load limit or any abuse or misuse of the product. Any questions concerning the use of Campbell products may be directed to your Apex Tool Group Sales Representative or Customer Service.

**NOTICE:** The product specifications and dimensions are as accurate as possible at the time of printing. However, because we are continually improving the quality and design of our products, they can change without notice.

The dimensions and weights are approximate nominal values, and some variation will occur. If specific dimensional requirements are necessary for the application, please contact your Apex Tool Group Sales Representative or Customer Service.



### ADVERTENCIA

Para prevenir la posibilidad de una lesión personal sería:

- **NO EXCEDA** los límites de carga de las cadenas o componentes.
- **NO LA UTILICE** para cargar hacia arriba o para izar.
- **NO LA UTILICE** si la cadena o los componentes están visualmente distorsionados o gastados.



### WARNING

To prevent the possibility of serious bodily injury:

- **DO NOT EXCEED** the working load limits for chain or components.
- **DO NOT USE** for overhead lifting or hoisting.
- **DO NOT USE** if the chain or components are visibly distorted or worn.





## Load Binders

- To Tighten Chain, Typically for Cargo Securement
- Meets U.S. D.O.T. 393.100 -393.102 Requirements for Use with Chain
- Lever Type: Allows for Quicker Application of Load
- Ratchet Type: Allows for Easier Adjustment of Tension and Greater Range of Take-Up
- DO NOT EXCEED THE WORKING LOAD LIMIT
- Do Not Use for Overhead Lifting or Hoisting



Catalog No.	UPC No. 020418	Style	For Chain Size & Grade	Finish	Take-Up	Quantity Per Package	Working Load Limit	Weight Each
6203205	178658	Lever Type, Imported	1/4" Gr.30 & Gr.43	Painted Red	2-3/4 in	4	2600 lb	3.40 lb
6203603	086441	Lever Type, Domestic	5/16" Gr.70 to 3/8" Gr.43	Painted Red	4-1/2 in	4	5400 lb	7.50 lb
6203604	187162	Lever Type, Imported	5/16" Gr.70 to 3/8" Gr.43	Painted Red	4-1/2 in	4	5400 lb	8.05 lb
6203605	190247	Lever Type, Domestic	3/8" Gr.70 to 1/2" Gr.43	Painted Red	4-1/2 in	Bulk	9200 lb	9.92 lb
6207504	086472	Ratchet Type, Imported	5/16" Gr.70 to 3/8" Gr.43	Painted Red	8 in	Bulk	5400 lb	11.00 lb
6207506	228940	Ratchet Type, Imported	5/16" Gr.70 to 3/8" Gr.70	Yellow Chromate	8 in	2	6600 lb	11.00 lb
6207803	189425	Ratchet Type, Imported	3/8" Gr.70 to 1/2" Gr.43	Painted Red	8 in	Bulk	9200 lb	9.92 lb
6207805	086489	Ratchet Type, Domestic	3/8" Gr.70 to 1/2" Gr.43	Painted Red	8 in	Bulk	9200 lb	12.50 lb

## Cable Pullers

- Feature Double Drive Ratchet Wheels
- Easy Let-Down Releases and Aircraft-Type, 3/16" Galvanized Cables
- Built-in Safety Handle is Designed to Bend if Recommended Working Load Limit is Exceeded
- Packaged 1 Per Box, with Operating Instructions
- CAUTION: Do Not Use Cable Pullers to Lift People or to Lift Loads Over People



Catalog No.	UPC No. 020418	Draw	Lift Capacity	Pull Capacity	Packaged	Weight Each	Shelf Pack
6312035	162701	10-1/2 ft	1/2 T	1 T	Boxed	8.80 lb	1
6312036	162718	6 ft	1 T	2 T	Boxed	9.50 lb	1

## S Hooks

- For Attaching Accessories to Chain
- After Engaging Chain, Close the “S” Hook to Prevent Disengagement
- Standard Material: Low Carbon Steel
- Order Unit is “Each”
- DO NOT EXCEED THE WORKING LOAD LIMIT
- Do Not Use for Overhead Lifting or Hoisting

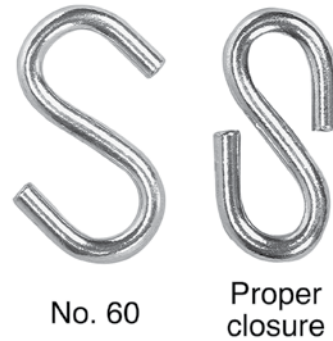

Trade Size	Catalog No.	UPC No. 020418	Finish	Wire Size	Inside Length	Pieces Per Package	Packaged	Working Load Limit	Weight Each	Shelf Pack
20	6102024*	084836	Zinc Plated	0.08 in	27/32 in	50	Bagged	16 lb	0.004 lb	50
40	6104024	084911	Zinc Plated	0.134 in	1 in	50	Boxed	42 lb	0.01 lb	50
40	B5954024	154843	Zinc Plated	0.134 in	1 in	6	Bagged	42 lb	0.07 lb	10
60	6106024	084980	Zinc Plated	0.187 in	1-13/16 in	50	Boxed	35 lb	0.04 lb	50
60	B5956024	154850	Zinc Plated	0.187 in	1-13/16 in	6	Bagged	35 lb	0.20 lb	10
61	6106124	085048	Zinc Plated	0.204 in	1-5/8 in	50	Boxed	120 lb	0.04 lb	50
62	6106224	085086	Zinc Plated	0.175 in	1-3/8 in	50	Boxed	60 lb	0.03 lb	50
70	6107014	085130	Bright	0.219 in	1-13/16 in	50	Boxed	100 lb	0.05 lb	50
72	6107224	085215	Zinc Plated	0.225 in	1-1/2 in	50	Boxed	100 lb	0.05 lb	50
80	6108024	085284	Zinc Plated	0.250 in	1-25/32 in	50	Boxed	120 lb	0.07 lb	50
80	B5955024	156663	Zinc Plated	0.250 in	1-25/32 in	6	Bagged	120 lb	0.42 lb	10
81	6108114	085338	Bright	0.250 in	2-1/2 in	50	Boxed	150 lb	0.08 lb	50
84	6108424	085444	Zinc Plated	0.250 in	1-25/32 in	50	Boxed	100 lb	0.06 lb	50
100	6101024	084737	Zinc Plated	0.312 in	2-1/4 in	50	Boxed	290 lb	0.12 lb	50
120	6101224	084782	Zinc Plated	0.375 in	2-3/8 in	50	Boxed	410 lb	0.20 lb	-
120	B5959024	156670	Zinc Plated	0.375 in	2-3/8 in	2	Bagged	410 lb	0.42 lb	10

\* Packed 50 Pieces per Bag

## Cold Shuts

- Connections for Chain and Attachments
- When Using Cold Shuts with Chain, Use One Size Larger Than Chain Size
- With A Hammer, Drive the Open End Through the Cold Shut Eye. Peen the Extended End to Prevent Opening
- Order Unit is “Each”
- Do Not Use for Overhead Lifting or Hoisting



Trade Size	Catalog No.	UPC No. 020418	Finish	Inside Length	Inside Width	Packaged	Working Load Limit	Weight Each	Shelf Pack
3/16 in	T4900324	180118	Zinc Plated	15/16 in	11/32 in	Bulk, UPC Tag	400 lb	0.02 lb	10
1/4 in	T4900424	180125	Zinc Plated	1-3/16 in	3/8 in	Bulk, UPC Tag	800 lb	0.06 lb	10
5/16 in	T4900524	201448	Zinc Plated	1-3/8 in	7/16 in	Bulk, UPC Tag	1300 lb	0.10 lb	10
3/8 in	T4900624	201455	Zinc Plated	1-1/2 in	5/8 in	Bulk, UPC Tag	1900 lb	0.16 lb	10
1/2 in	T4900824	201462	Zinc Plated	1-7/8 in	3/4 in	Bulk, UPC Tag	3700 lb	0.38 lb	10



## Repair and Lap Links

- Connections for Chain and Attachments
- Chain is Inserted, Then Link is Hammered Closed
- Standard Material: Low Carbon Steel
- DO NOT EXCEED THE WORKING LOAD LIMIT



Trade Size	Catalog No.	UPC No. 020418	Finish	Quantity Per Package	Packaged	Working Load Limit	Weight Each	Shelf Pack
1/8 in x 3/4 in	T5950024	192807	Zinc Plated	10	Bulk, UPC Tag	125 lb	0.01 lb	10
3/16 in x 1 in	T5800124	258510	Zinc Plated	100	Carton	240 lb	0.03 lb	100
3/16 in x 1 in	B5950124	156540	Zinc Plated	6	Bulk, UPC Tag	240 lb	0.03 lb	10
3/16 in x 1 in	T5950124	192623	Zinc Plated	10	Bulk, UPC Tag	240 lb	0.03 lb	10
1/4 in x 1-1/4 in	5800324	081163	Zinc Plated	50	Carton	400 lb	0.07 lb	50
1/4 in x 1-1/4 in	B5950324	156557	Zinc Plated	4	Bulk, UPC Tag	400 lb	0.07 lb	10
1/4 in x 1-1/4 in	T5950324	192593	Zinc Plated	10	Bulk, UPC Tag	400 lb	0.07 lb	10
5/16 in x 1-1/2 in	5800724	081330	Zinc Plated	50	Carton	700 lb	0.10 lb	50
5/16 in x 1-1/2 in	B5950724	156571	Zinc Plated	2	Bulk, UPC Tag	700 lb	0.10 lb	10
5/16 in x 1-1/2 in	T5950724	192609	Zinc Plated	10	Bulk, UPC Tag	700 lb	0.10 lb	10
3/8 in x 1-5/8 in	5800924	081422	Zinc Plated	50	Carton	1250 lb	0.20 lb	-
3/8 in x 1-5/8 in	T5950924	192616	Zinc Plated	10	Bulk, UPC Tag	1250 lb	0.20 lb	10
3/8 in x 2 in	5801024	081484	Zinc Plated	50	Carton	1250 lb	0.20 lb	-
1/2 in x 2-1/2 in	5801124	081521	Zinc Plated	25	Carton	2125 lb	0.53 lb	-

ACCESSORIES

## Double Clevises

- Forged Steel
- For Use with Proof Coil or High Test Chain
- Order Unit is "Each"
- DO NOT EXCEED THE WORKING LOAD LIMIT
- Do Not Use for Overhead Lifting or Hoisting

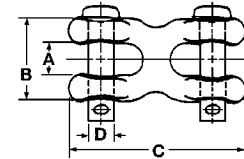

Trade Size	Catalog No.	UPC No. 020418	Finish	A Dim.	B Dim.	C Dim.	D Dim.	Working Load Limit	Weight Each	Shelf Pack
1/4 in x 5/16 in	T5423300	191534	Zinc Plated	7/16 in	1-1/16 in	2-1/2 in	3/8 in	3900 lb	0.36 lb	10
3/8 in	T5423301	191541	Zinc Plated	1/2 in	1-5/16 in	2-27/32 in	7/16 in	5400 lb	0.55 lb	10
7/16 in x 1/2 in	T5423302	204869	Zinc Plated	5/8 in	1-5/8 in	3-5/8 in	9/16 in	9200 lb	1.04 lb	5

## Yellow Chromate Hitch Pins

- Forged Steel
- Standard Finish: Zinc Plate with Yellow Chromate
- Includes Hair Pin Clip
- UPC Tagged
- Order Unit is "Each"



Catalog No.	UPC No. 020418	Pin Diameter	Usable Length	Packaged	Weight Each	Shelf Pack	Case Pack
T3899733	257421	3/8 in	3 in	Bulk, UPC Tag	0.20 lb	5	40
T3899724	257414	1/2 in	4-1/4 in	Bulk, UPC Tag	0.36 lb	5	40
T3899720	210952	5/8 in	4 in	Bulk, UPC Tag	0.60 lb	4	40
T3899752	210990	5/8 in	6 in	Bulk, UPC Tag	0.80 lb	4	40
T3899728	210969	3/4 in	4-1/4 in	Bulk, UPC Tag	1.00 lb	4	40
T3899760	211003	3/4 in	6-1/4 in	Bulk, UPC Tag	1.10 lb	4	40
T3899736	210976	7/8 in	4-1/4 in	Bulk, UPC Tag	1.20 lb	2	20
T3899768	211010	7/8 in	6-1/2 in	Bulk, UPC Tag	1.50 lb	2	20
T3899744	210983	1 in	4-1/2 in	Bulk, UPC Tag	1.60 lb	2	20
T3899776	211027	1 in	6-3/4 in	Bulk, UPC Tag	2.10 lb	2	20

## Red Handle Hitch Pins

- Forged, Heated Treated, Grade 5 Strength
- Pin Has Black Powder Coating with A Red Vinyl Coated Head and Handle with Yellow Zinc Plated Hair Pin Clip
- UPC Tagged
- Order Unit is "Each"



Catalog No.	UPC No. 020418	Pin Diameter	Usable Length	Packaged	Weight Each	Shelf Pack	Case Pack
T3898910	257490	1/2 in	3-5/8 in	Bulk, UPC Tag	0.49 lb	5	20
T3898954	257483	5/8 in	4 in	Bulk, UPC Tag	0.67 lb	5	20
T3898956	257476	5/8 in	5-1/2 in	Bulk, UPC Tag	0.79 lb	5	20
T3898934	257452	3/4 in	4-1/2 in	Bulk, UPC Tag	1.04 lb	2	10
T3898936	257469	3/4 in	6-1/2 in	Bulk, UPC Tag	1.27 lb	2	10
T3898976	257445	7/8 in	6-1/2 in	Bulk, UPC Tag	1.74 lb	-	5
T3898917	257438	1 in	7-1/2 in	Bulk, UPC Tag	2.38 lb	-	5



## Hitch Pin Clips

- Replacement Clips for Hitch Pins
- Yellow Zinc Plated for Corrosion Resistance
- Order Unit is "Bag"



Trade Size	Catalog No.	UPC No. 020418	Fits Pin Dia. (in.)	Wire Size	I.D. Of Eye	Overall Length	Pieces Per Package	Weight Each	Shelf Pack
1/16 in	B3899816	257513	3/8 in	0.077 in	7/16 in	1-3/4 in	10	0.06 lb	10
3/32 in	B3899832	257520	3/8 in	0.099 in	1/2 in	2 in	10	0.09 lb	10
1/8 in	B3899818	257537	1/2 in	0.11 in	3/4 in	3 in	10	0.15 lb	10
5/32 in	B3899852	257544	1/2 in & 5/8 in	0.15 in	3/4 in	3-1/8 in	7	0.23 lb	10
3/16 in	B3899836	257551	3/4 in & 7/8 in	0.188 in	1 in	4 in	5	0.34 lb	10
1/4 in	B3899814	257568	1 in	0.23 in	1-1/4 in	5 in	2	0.26 lb	10

ACCESSORIES

## Tractor Draw Bar Hook

- Forged, Heat Treated Steel
- Blue Powder Coat Finish on Hook
- Design Factor: 4 to 1
- Can Be Used with 5/16" to 1/2" Grade 30 or Grade 43 Chain
- UPC Tagged
- DO NOT EXCEED THE WORKING LOAD LIMIT



Trade Size	Catalog No.	UPC No. 020418	Hook Style	Finish	Working Load Limit	Weight Each	Case Pack
1/2 in	T9501805	257575	Clevis	Super Blue	9200 lb	3.09 lb	5

## Straight and Twisted Clevises

- Forged Steel
- UPC Tagged
- DO NOT EXCEED THE WORKING LOAD LIMIT
- Do Not Use for Overhead Lifting or Hoisting

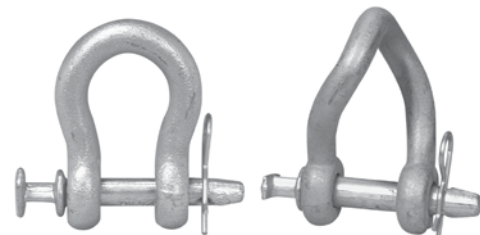

Catalog No.	UPC No. 020418	Body Type	Finish	Body Diameter	Pin Diameter	Working Load Limit	Weight Each	Shelf Pack
T3899910	211775	Straight, Short	Electro-Galvanized	7/8 in	3/4 in	16000 lb	2.97 lb	5
T3899913	211768	Twisted, Short	Electro-Galvanized	7/8 in	3/4 in	16000 lb	2.97 lb	3
T3899916	211799	Straight, Long	Electro-Galvanized	7/8 in	3/4 in	16000 lb	3.30 lb	2
T3899919	211782	Twisted, Long	Electro-Galvanized	7/8 in	3/4 in	16000 lb	3.30 lb	2

## Utility Clevises

- Forged Steel
- Blue Powder Coat Finish
- Design Factor: 5 to 1
- Working Load Limit Marked on Clevis Body
- UPC Tagged
- DO NOT EXCEED THE WORKING LOAD LIMIT



Trade Size	Catalog No.	UPC No. 020418	Style	Finish	Working Load Limit (Short Tons)	Packaged	Weight Each	Shelf Pack	Case Pack
1/4 in	T9420405	257292	Round Pin	Super Blue	1/2 T	Bulk, UPC Tag	0.10 lb	10	100
5/16 in	T9420505	257285	Round Pin	Super Blue	3/4 T	Bulk, UPC Tag	0.17 lb	10	100
3/8 in	T9420605	257278	Round Pin	Super Blue	1 T	Bulk, UPC Tag	0.27 lb	10	100
7/16 in	T9420705	257254	Round Pin	Super Blue	1-1/2 T	Bulk, UPC Tag	0.38 lb	5	50
1/2 in	T9420805	257247	Round Pin	Super Blue	2 T	Bulk, UPC Tag	0.60 lb	5	50
5/8 in	T9421005	257261	Round Pin	Super Blue	3-1/4 T	Bulk, UPC Tag	1.17 lb	-	25

## Farm Clevises

- Forged Steel
- Blue Powder Coat Finish
- Design Factor: 5 to 1
- Working Load Limit Marked on Clevis Body
- UPC Tagged
- DO NOT EXCEED THE WORKING LOAD LIMIT



Trade Size	Catalog No.	UPC No. 020418	Style	Finish	Working Load Limit (Short Tons)	Packaged	Weight Each	Shelf Pack	Case Pack
1/4 in	T9640405	257407	Screw Pin	Super Blue	1/2 T	Bulk, UPC Tag	0.10 lb	10	100
5/16 in	T9640505	257391	Screw Pin	Super Blue	3/4 T	Bulk, UPC Tag	0.18 lb	10	100
3/8 in	T9640605	257384	Screw Pin	Super Blue	1 T	Bulk, UPC Tag	0.30 lb	10	100
7/16 in	T9640705	257377	Screw Pin	Super Blue	1-1/2 T	Bulk, UPC Tag	0.40 lb	5	50
1/2 in	T9640805	257360	Screw Pin	Super Blue	2 T	Bulk, UPC Tag	0.63 lb	5	50
5/8 in	T9641005	257353	Screw Pin	Super Blue	3-1/4 T	Bulk, UPC Tag	1.34 lb	-	25
3/4 in	T9641205	257346	Screw Pin	Super Blue	4-3/4 T	Bulk, UPC Tag	2.22 lb	-	15
7/8 in	T9641405	257339	Screw Pin	Super Blue	6-1/2 T	Bulk, UPC Tag	3.34 lb	-	10
1 in	T9641605	257322	Screw Pin	Super Blue	8-1/2 T	Bulk, UPC Tag	4.93 lb	-	5
1-1/8 in	T9641805	257315	Screw Pin	Super Blue	9-1/2 T	Bulk, UPC Tag	6.79 lb	-	5
1-1/4 in	T9642005	257308	Screw Pin	Super Blue	12 T	Bulk, UPC Tag	9.93 lb	-	5



## Welded Rings

- Made of Low Carbon Steel
- General Attachment for Chain or Rope
- DO NOT EXCEED THE WORKING LOAD LIMIT
- Do Not Use for Overhead Lifting or Hoisting



Trade Size	Catalog No.	UPC No. 020418	Inside Diameter	Finish	Packed Per Box	Packaged	Working Load Limit	Weight Each	Shelf Pack
3/16 in	6050314	083518	1-1/4 in	Bright	25	Carton	200 lb	0.03 lb	25
3/16 in	6050324	083532	1-1/4 in	Zinc Plated	25	Carton	200 lb	0.03 lb	25
1/4 in	6050414	083556	1-1/2 in	Bright	25	Carton	450 lb	0.08 lb	25
1/4 in	6050424	083570	1-1/2 in	Zinc Plated	25	Carton	450 lb	0.08 lb	25
1/4 in	6052414	083914	2 in	Bright	25	Carton	350 lb	0.10 lb	25
5/16 in	6050514	083600	2 in	Bright	25	Carton	600 lb	0.16 lb	25
3/8 in	6050614	083655	2 in	Bright	25	Carton	900 lb	0.23 lb	25
3/8 in	6050624	083679	2 in	Zinc Plated	25	Carton	900 lb	0.20 lb	25
3/8 in	6053614	084164	3 in	Bright	25	Carton	700 lb	0.33 lb	-
1/2 in	6052814	084027	2-1/2 in	Bright	10	Carton	1400 lb	0.60 lb	10
5/8 in	6051014	083747	4 in	Bright	10	Carton	1700 lb	1.45 lb	-

ACCESSORIES

## Seven Seas Welded Rings

- Made of Low Carbon Steel
- For Use in the Construction of Scallop Dredge Nets
- Order Unit is "Pound"
- Do Not Use for Overhead Lifting or Hoisting



Trade Size	Catalog No.	UPC No. 020418	Inside Diameter	Pounds Per Pail	Pieces Per Package	Working Load Limit	Shelf Pack
1/4 in	6052418*	083938	2 in	50 lb	500	350 lb	50
7/16 in	6055888~*		3-1/2 in	50 lb	100	-	-
7/16 in	6055988~*	193521	4 in	50 lb	80	-	-

\* Pieces per Package is Approximate; ~ Case Hardened

## Seven Seas Net Links

- Shaped to Facilitate Uniform Closing
- Links Are Heat Treated
- Provide the Hardness and Strength Required for Deep Sea Scallop Dredging
- Order Unit is "Pound"



Trade Size	Catalog No.	UPC No. 020418	Wire Size	Inside Length	Pounds Per Pail	Pieces Per Package	Shelf Pack
719	6010898*	083440	3/8 in	1-1/8 in	50 lb	375	50
719	6011898*	189418	3/8 in	1 in	50 lb	500	50

\* Pieces per Package is Approximate

## Welded Rings (Imported)

- For General Chain & Rope Attachment
- Do Not Use for Overhead Lifting or Hoisting



Figure No.	Trade Size	Catalog No.	UPC No. 020418	Style	Finish	Packaged	A Dim.	B Dim.	Working Load Limit	Weight Each	Shelf Pack	Case Pack
7	1 in	T7665012	201301	Steel Ring	Nickel Plated	Bulk, UPC Tag	1.00 in	0.18 in	200 lb	0.03 lb	10	100
7B	1-1/8 in	T7662114	201288	Solid Bronze Ring	Polished	Bulk, UPC Tag	1.125 in	0.21 in	150 lb	0.04 lb	10	100
4	1-1/4 in	T7660841	192845	Steel Ring	Zinc Plated	Bulk, UPC Tag	1.25 in	0.22 in	200 lb	0.05 lb	10	100
7	1-1/4 in	T7665032	201318	Steel Ring	Nickel Plated	Bulk, UPC Tag	1.25 in	0.18 in	200 lb	0.03 lb	10	100
3	1-1/2 in	T7665042	201325	Steel Ring	Nickel Plated	Bulk, UPC Tag	1.50 in	0.24 in	200 lb	0.05 lb	10	100
3	2 in	T7661152	192036	Steel Ring	Nickel Plated	Bulk, UPC Tag	2.00 in	0.24 in	200 lb	0.09 lb	10	100
7B	2 in	T7662154	192050	Solid Bronze Ring	Polished	Bulk, UPC Tag	2.00 in	0.25 in	150 lb	0.12 lb	10	100
-	2 in	T7663550	211898	Hitch Ring w/3-1/2" Screw Eye	Zinc Plated	Bulk, UPC Tag	2.00 in	0.26 in	90 lb	0.21 lb	5	50
2	2 in	T7665001	201295	Steel Ring	Nickel Plated	Bulk, UPC Tag	2.00 in	0.26 in	200 lb	0.10 lb	10	100
2	2-1/2 in	T7661361	192043	Steel Ring	Zinc Plated	Bulk, UPC Tag	2.50 in	0.26 in	200 lb	0.14 lb	10	100

## Dees

- Used to Attach a Strap to an Accessory
- Do Not Use for Overhead Lifting or Hoisting

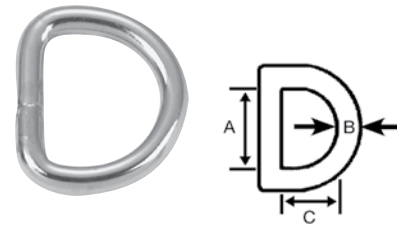

Figure No.	Trade Size	Catalog No.	UPC No. 020418	Finish	Packaged	A Dim.	B Dim.	C Dim.	Working Load Limit	Weight Each	Shelf Pack	Case Pack
3250	1 in	T7662322	204821	Nickel Plated	Bulk, UPC Tag	1.00 in	0.21 in	0.81 in	200 lb	0.03 lb	10	100
3250	1-1/4 in	T7662342	192067	Zinc Plated	Bulk, UPC Tag	1.25 in	0.24 in	1.125 in	200 lb	0.07 lb	10	100
3250	1-1/2 in	T7662351	192074	Zinc Plated	Bulk, UPC Tag	1.50 in	0.24 in	1.50 in	200 lb	0.08 lb	10	100
3250	2 in	T7662372	204845	Nickel Plated	Bulk, UPC Tag	2.00 in	0.26 in	1.75 in	200 lb	0.11 lb	10	100

## Open Eye Swivels

- Used to Couple Weldless Chain, Prevents Tangling
- Eyes Easily Closed with Hammer



Size No.	Catalog No.	UPC No. 020418	For Chain Size	Finish	Packaged	Working Load Limit	Weight Each	Shelf Pack
1020	T5901024	192852	1/0 & 2/0 Inco (Double Loop)	Zinc Plated	Bulk, UPC Tag	100 lb	0.05 lb	10

ACCESSORIES





## Double End Swivels

- Used for Connecting Chain or Rope
- Swivel Feature Allows for Less Kinking or Tangling of Chain
- Zinc Die Cast Construction
- DO NOT EXCEED THE WORKING LOAD LIMIT
- Do Not Use for Overhead Lifting or Hoisting



Figure No.	Trade Size	Catalog No.	UPC No. 020418	Finish	Eye Size	Length	Packaged	Working Load Limit	Weight Each	Shelf Pack	Case Pack
2225Z	5/8 in	T7640302	191930	Nickel Plated	5/8	2-11/16 in	Bulk, UPC Tag	90 lb	0.08 lb	10	100
2225Z	3/4 in	T7616202	191831	Nickel Plated	3/4	3 in	Bulk, UPC Tag	100 lb	0.08 lb	10	100
2225Z	1 in	T7640322	191947	Nickel Plated	1	3-9/16 in	Bulk, UPC Tag	100 lb	0.18 lb	10	100

ACCESSORIES

## Tie Out Stake

- Spiral Tie Out Stake

Figure No.	Trade Size	Catalog No.	UPC No. 020418	Finish	Weight Each	Case Pack
1949	15-1/2 in	T7692006	144936	Zinc Plated	0.90 lb	25



## Gate Hook

- Gate Hook, Reverse Eye, with Steel Staples (2)
- Packaged in Retail Polybag

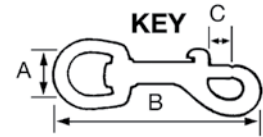

Figure No.	Trade Size	Catalog No.	UPC No. 020418	Finish	Packaged	A Dim.	B Dim.	C Dim.	Weight Each	Shelf Pack	Case Pack
444	3/8 in	B7606601	156724	Zinc Plated	Bagged	3/8 in	4 in	1/4 in	0.16 lb	10	100

## Malleable Iron and Steel Snaps

- Typical uses include Tarp Covers, Key Rings, Gate Closures, Flagpoles, and Other Home, Farm, Recreational and Marine Applications
- Also Ideal for Pet Leashes and Tie-Outs
- DO NOT EXCEED THE WORKING LOAD LIMIT
- Do Not Use for Overhead Lifting or Hoisting

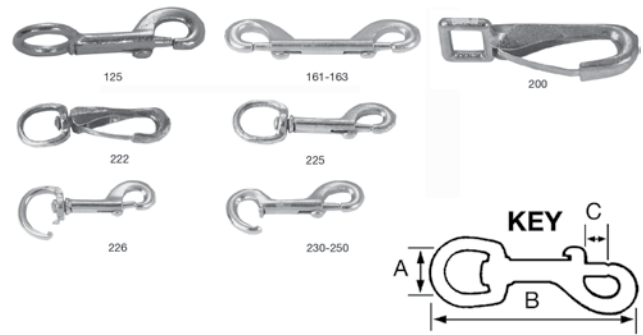
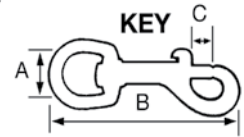

Figure No.	Trade Size	Catalog No.	UPC No. 020418	Style	Finish	Packaged	A Dim.	B Dim.	C Dim.	Working Load Limit	Weight Each	Shelf Pack	Case Pack
125	5/8 in	T7600311	191558	Rigid, Round Eye Bolt Snap	Zinc Plated	Bulk, UPC Tag	5/8 in	5 in	11/32 in	70 lb	0.14 lb	10	100
161	3-1/2 in	T7605501	201028	Double Ended Bolt Snap	Zinc Plated	Bulk, UPC Tag	-	3-1/2 in	9/32 in	70 lb	0.10 lb	10	100
162	4-1/8 in	T7605511	191671	Double Ended Bolt Snap	Zinc Plated	Bulk, UPC Tag	-	4-1/8 in	13/32 in	70 lb	0.14 lb	10	100
163	4-3/4 in	T7605521	191688	Double Ended Bolt Snap	Zinc Plated	Bulk, UPC Tag	-	4-3/4 in	3/8 in	110 lb	0.18 lb	10	100
200	3/4 in	T7600511	201004	Rigid, Strap Eye Spring Snap	Zinc Plated	Bulk, UPC Tag	3/4 in	3 in	3/8 in	80 lb	0.08 lb	10	100
200	1 in	T7600531	201011	Rigid, Strap Eye Spring Snap	Zinc Plated	Bulk, UPC Tag	1 in	3-1/4 in	7/16 in	90 lb	0.10 lb	10	100
200	1-1/2 in	T7600561	192821	Rigid, Strap Eye Spring Snap	Zinc Plated	Bulk, UPC Tag	1-1/2 in	3-13/16 in	1/2 in	80 lb	0.10 lb	10	100
222	3/4 in	T7605701	192814	Swiveling, Round Eye Spring Snap	Zinc Plated	Bulk, UPC Tag	3/4 in	3-3/4 in	7/16 in	70 lb	0.12 lb	10	100
225	1/2 in	T7601201	191565	Swiveling, Round Eye Bolt Snap	Zinc Plated	Bulk, UPC Tag	1/2 in	4 in	3/8 in	110 lb	0.13 lb	10	100
225	5/8 in	T7605801	191695	Swiveling, Round Eye Bolt Snap	Zinc Plated	Bulk, UPC Tag	5/8 in	4 in	3/8 in	110 lb	0.14 lb	10	100
225	3/4 in	T7605811	191701	Swiveling, Round Eye Bolt Snap	Zinc Plated	Bulk, UPC Tag	3/4 in	4-1/4 in	3/8 in	100 lb	0.14 lb	10	100
225	1 in	T7605821	191718	Swiveling, Round Eye Bolt Snap	Zinc Plated	Bulk, UPC Tag	1 in	4-5/8 in	15/32 in	100 lb	0.20 lb	10	100
226	1 in	T7601311	191572	Swiveling, Open Eye Bolt Snap	Zinc Plated	Bulk, UPC Tag	1 in	4-3/4 in	15/32 in	30 lb	0.24 lb	10	100
230	3/8 in	T7606001	201035	Rigid, Open Eye Bolt Snap	Zinc Plated	Bulk, UPC Tag	3/8 in	3-3/8 in	11/32 in	40 lb	0.10 lb	10	100
231	3/8 in	T7606011	191725	Rigid, Open Eye Bolt Snap	Zinc Plated	Bulk, UPC Tag	3/8 in	3-1/2 in	13/32 in	60 lb	0.12 lb	10	100
232	1/2 in	T7606021	191732	Rigid, Open Eye Bolt Snap	Zinc Plated	Bulk, UPC Tag	1/2 in	4 in	7/16 in	60 lb	0.15 lb	10	100
240	1/2 in	T7606031	191749	Rigid, Open Eye Bolt Snap	Zinc Plated	Bulk, UPC Tag	1/2 in	4-1/4 in	15/32 in	100 lb	0.23 lb	10	100
245	1/2 in	T7601451	191589	Rigid, Open Eye Bolt Snap	Zinc Plated	Bulk, UPC Tag	1/2 in	5-1/4 in	1/2 in	200 lb	0.42 lb	10	50
250	5/8 in	T7601461	191596	Rigid, Open Eye Bolt Snap	Zinc Plated	Bulk, UPC Tag	5/8 in	7 in	9/16 in	240 lb	0.64 lb	10	100



## Malleable Iron and Steel Snaps

- Typical uses include Tarp Covers, Key Rings, Gate Closures, Flagpoles, and Other Home, Farm, Recreational and Marine Applications
- Also Ideal for Pet Leashes and Tie-Outs
- DO NOT EXCEED THE WORKING LOAD LIMIT
- Do Not Use for Overhead Lifting or Hoisting



ACCESSORIES

Figure No.	Trade Size	Catalog No.	UPC No. 020418	Style	Finish	Packaged	A Dim.	B Dim.	C Dim.	Working Load Limit	Weight Each	Shelf Pack	Case Pack
333	7/8 in	T7601801	191602	Swiveling, Round Eye Animal Snap	Zinc Plated	Bulk, UPC Tag	7/8 in	5 in	9/16 in	440 lb	0.66 lb	10	50
334	3/8 in	T7601912	191619	Swiveling, Round Eye Spring Snap	Nickel Plated	Bulk, UPC Tag	3/8 in	2 in	5/32 in	20 lb	0.02 lb	10	100
334	1/4 in	T7606102	201042	Swiveling, Round Eye Spring Snap	Nickel Plated	Bulk, UPC Tag	1/4 in	1-7/8 in	5/32 in	20 lb	0.02 lb	10	100
341	3/8 in	T7602301	192630	Rigid, Round Eye Spring Snap	Zinc Plated	Bulk, UPC Tag	3/8 in	2 in	5/32 in	30 lb	0.03 lb	10	100
407	3/4 in	T7606301	201059	Swiveling, Round Eye Spring Snap	Zinc Plated	Bulk, UPC Tag	3/4 in	4-1/8 in	9/32 in	80 lb	0.10 lb	10	100
424	2-1/2 in	T7602611	191626	Breaching Snap	Zinc Plated	Bulk, UPC Tag	-	2-1/2 in	9/32 in	80 lb	0.06 lb	10	100
437	3/8 in	T7606502	191756	Swiveling, Round Eye Spring Snap	Nickel Plated	Bulk, UPC Tag	3/8 in	2-1/2 in	7/32 in	30 lb	0.04 lb	10	100
822	5/8 in	T7603211	204555	Rigid, Round Eye Cap Snap	Zinc Plated	Bulk, UPC Tag	5/8 in	5 in	9/16 in	320 lb	0.32 lb	10	100
830	1 in	T7603441	191640	Swiveling, Round Eye Cap Snap	Zinc Plated	Bulk, UPC Tag	1 in	4-1/2 in	7/16 in	190 lb	0.22 lb	10	100
830	3/4 in	T7606801	201066	Swiveling, Round Eye Cap Snap	Zinc Plated	Bulk, UPC Tag	3/4 in	3-1/2 in	11/32 in	100 lb	0.13 lb	10	100
855	5-1/4 in	T7603911	193712	Double Ended Cap Snap	Zinc Plated	Bulk, UPC Tag	-	5-1/4 in	7/16 in	250 lb	0.26 lb	10	100
1001	1/2 in	T7604002	191657	Rigid, Round Eye Panic Snap	Zinc Plated	Bulk, UPC Tag	1/2 in	4 in	-	140 lb	0.31 lb	10	100
1405	2-7/8 in	T7607306	192838	Swiveling, Open Eye Spring Snap	Zinc Plated	Bulk, UPC Tag	-	2-7/8 in	1/4 in	30 lb	0.06 lb	10	10
1407	3-3/4 in	T7607301	201073	Swiveling, Open Eye Spring Snap	Zinc Plated	Bulk, UPC Tag	-	3-3/4 in	5/16 in	60 lb	0.06 lb	10	100
2311F	3/4 in	T7620934	238130	Latched, Snap Hook	Zinc Plated	Bulk, UPC Tag	3/4 in	4 in	7/8 in	750 lb	0.33 lb	10	100
3142	7/8 in	T7607401	191763	Swiveling, Round Eye Animal Snap	Zinc Plated	Bulk, UPC Tag	7/8 in	4-7/8 in	7/8 in	300 lb	0.44 lb	10	100
3369	5/8 in	T7620794	204609	Rigid, Fixed Eye Hook	Zinc Plated	Bulk, UPC Tag	5/8 in	3-5/8 in	9/16 in	1000 lb	0.33 lb	10	100
5013	5/8 in	T7604622	191664	Swiveling, Strap Eye Trigger Snap	Nickel Plated	Bulk, UPC Tag	5/8 in	2-1/2 in	3/8 in	70 lb	0.09 lb	10	100

## Die Cast Zinc Snaps

- Typical uses include Tarp Covers, Key Rings, Gate Closures, Flagpoles, and Other Home, Farm, Recreational and Marine Applications
- Also Ideal for Pet Leashes and Tie-Outs
- Zinc Die Cast Construction
- DO NOT EXCEED THE WORKING LOAD LIMIT
- Do Not Use for Overhead Lifting or Hoisting

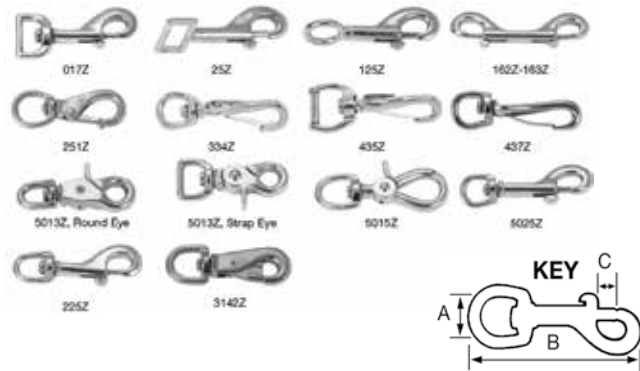

Figure No.	Trade Size	Catalog No.	UPC No. 020418	Style	Finish	Packaged	A Dim.	B Dim.	C Dim.	Working Load Limit	Weight Each	Shelf Pack	Case Pack
017Z	1 in	T7610102	201097	Swiveling, Strap Eye Bolt Snap	Nickel Plated	Bulk, UPC Tag	1 in	3-3/16 in	3/8 in	80 lb	0.10 lb	10	100
25Z	1 in	T7615102	191794	Rigid, Strap Eye Bolt Snap	Nickel Plated	Bulk, UPC Tag	1 in	3-1/16 in	3/8 in	40 lb	0.09 lb	10	100
125Z	5/8 in	T7615202	201127	Rigid, Round Eye Bolt Snap	Nickel Plated	Bulk, UPC Tag	5/8 in	3-3/8 in	3/8 in	90 lb	0.08 lb	10	100
162Z	-	T7615302	201134	Double Ended Bolt Snap	Nickel Plated	Bulk, UPC Tag	-	4 in	3/8 in	60 lb	0.11 lb	10	100
163Z	-	T7615312	191800	Double Ended Bolt Snap	Nickel Plated	Bulk, UPC Tag	-	4-5/8 in	7/16 in	70 lb	0.15 lb	10	100
225Z	1/2 in	T7615012	201110	Swiveling, Round Eye Bolt Snap	Nickel Plated	Bulk, UPC Tag	1/2 in	3-1/2 in	3/8 in	90 lb	0.09 lb	10	100
225Z	5/8 in	T7615402	201141	Swiveling, Round Eye Bolt Snap	Nickel Plated	Bulk, UPC Tag	5/8 in	3-1/2 in	3/8 in	80 lb	0.10 lb	10	100
225Z	3/4 in	T7615412	201158	Swiveling, Round Eye Bolt Snap	Nickel Plated	Bulk, UPC Tag	3/4 in	3-11/16 in	3/8 in	70 lb	0.11 lb	10	100
225Z	1 in	T7615422	201165	Swiveling, Round Eye Bolt Snap	Nickel Plated	Bulk, UPC Tag	1 in	4-1/4 in	1/2 in	90 lb	0.17 lb	10	100
251Z	1 in	T7610832	201103	Swiveling, Round Eye Quick Snap	Nickel Plated	Bulk, UPC Tag	1 in	3-13/16 in	5/8 in	70 lb	0.14 lb	10	100
251Z	5/8 in	T7615502	191817	Swiveling, Round Eye Quick Snap	Nickel Plated	Bulk, UPC Tag	5/8 in	3-3/8 in	5/8 in	80 lb	0.13 lb	10	100
334Z	1/4 in	T7615602	191824	Swiveling, Round Eye Spring Snap	Nickel Plated	Bulk, UPC Tag	1/4 in	2 in	7/32 in	20 lb	0.02 lb	10	100
435Z	5/8 in	T7615802	201172	Swiveling, Strap Eye Spring Snap	Nickel Plated	Bulk, UPC Tag	5/8 in	2-5/8 in	9/32 in	30 lb	0.04 lb	10	100
437Z	3/8 in	T7615902	201189	Swiveling, Round Eye Spring Snap	Nickel Plated	Bulk, UPC Tag	3/8 in	2-9/16 in	9/32 in	30 lb	0.02 lb	10	100
3142Z	7/8 in	T7616302	191848	Swiveling, Round Eye Animal Snap	Nickel Plated	Bulk, UPC Tag	7/8 in	4-13/16 in	7/8 in	150 lb	0.35 lb	10	100
5013Z	3/8 in	T7616402	193538	Swiveling, Round Eye Trigger Snap	Nickel Plated	Bulk, UPC Tag	3/8 in	2-7/16 in	3/8 in	30 lb	0.09 lb	10	100
5013Z	1/2 in	T7616412	179723	Swiveling, Round Eye Trigger Snap	Nickel Plated	Bulk, UPC Tag	1/2 in	2-11/16 in	3/8 in	40 lb	0.08 lb	10	100
5015Z	3/4 in	T7616602	191855	Swiveling, Round Eye Trigger Snap	Nickel Plated	Bulk, UPC Tag	3/4 in	4 in	9/16 in	90 lb	0.15 lb	10	100



## Solid Bronze Snaps

- Typical uses include Tarp Covers, Key Rings, Gate Closures, Flagpoles, and Other Home, Farm, Recreational and Marine Applications
- Also Ideal for Pet Leashes and Tie-Outs
- DO NOT EXCEED THE WORKING LOAD LIMIT
- Do Not Use for Overhead Lifting or Hoisting

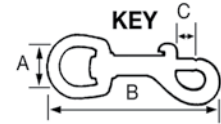

Figure No.	Trade Size	Catalog No.	UPC No. 020418	Style	Finish	Packaged	A Dim.	B Dim.	C Dim.	Working Load Limit	Weight Each	Shelf Pack	Case Pack
161B	-	T7625004	201226	Double Ended Bolt Snap	Polished	Bulk, UPC Tag	-	3-13/32 in	5/16 in	60 lb	0.10 lb	10	100
163B	-	T7625014	201233	Double Ended Bolt Snap	Polished	Bulk, UPC Tag	-	4-1/2 in	13/32 in	100 lb	0.18 lb	10	100
225B	1-1/4 in	T7620334	191862	Swiveling, Round Eye Bolt Snap	Polished	Bulk, UPC Tag	1-1/4 in	4-3/4 in	19/32 in	120 lb	0.30 lb	10	100
225B	5/8 in	T7625104	191886	Swiveling, Round Eye Bolt Snap	Polished	Bulk, UPC Tag	5/8 in	3-1/8 in	3/8 in	70 lb	0.12 lb	10	100
225B	3/4 in	T7625114	179785	Swiveling, Round Eye Bolt Snap	Polished	Bulk, UPC Tag	3/4 in	3-1/8 in	3/8 in	70 lb	0.12 lb	10	100
225B	1 in	T7625124	191893	Swiveling, Round Eye Bolt Snap	Polished	Bulk, UPC Tag	1 in	3-17/32 in	3/8 in	90 lb	0.10 lb	10	100
231B	3/8 in	T7625204	179792	Rigid, Open Eye Bolt Snap	Polished	Bulk, UPC Tag	3/8 in	3-13/32 in	3/8 in	70 lb	0.15 lb	10	100
249B	3/4 in	T7620534	201202	Rigid, Round Eye Quick Snap	Polished	Bulk, UPC Tag	3/4 in	3-15/64 in	9/16 in	140 lb	0.28 lb	10	100
249B	3/8 in	T7625304	201240	Rigid, Round Eye Quick Snap	Polished	Bulk, UPC Tag	3/8 in	2-5/32 in	9/32 in	60 lb	0.07 lb	10	100
249B	5/8 in	T7625314	201257	Rigid, Round Eye Quick Snap	Polished	Bulk, UPC Tag	5/8 in	2-7/8 in	3/4 in	70 lb	0.10 lb	10	100
249B	11/16 in	T7625324	193743	Rigid, Round Eye Quick Snap	Polished	Bulk, UPC Tag	11/16 in	3-29/32 in	19/32 in	100 lb	0.18 lb	10	100
251B	11/16 in	T7620614	201219	Swiveling, Round Eye Quick Snap	Polished	Bulk, UPC Tag	11/16 in	3-11/16 in	7/16 in	60 lb	0.02 lb	10	100
251B	5/8 in	T7625404	201264	Swiveling, Round Eye Quick Snap	Polished	Bulk, UPC Tag	5/8 in	3-1/8 in	5/16 in	60 lb	0.10 lb	10	100
251B	3/4 in	T7625434	201271	Swiveling, Round Eye Quick Snap	Polished	Bulk, UPC Tag	3/4 in	4-1/2 in	9/16 in	140 lb	0.30 lb	10	100
2311B	3/4 in	T7620804	191879	Latched, Snap Hook	Polished	Bulk, UPC Tag	3/4 in	4-1/16 in	5/8 in	140 lb	0.29 lb	10	100
5013B	1/2 in	T7625504	191909	Swiveling, Round Eye Trigger Snap	Polished	Bulk, UPC Tag	1/2 in	2-1/2 in	1/2 in	40 lb	0.09 lb	10	100
5025B	3/8 in	T7625604	191916	Swiveling, Round Eye Bolt Snap	Polished	Bulk, UPC Tag	3/8 in	2-15/16 in	1/4 in	80 lb	0.08 lb	10	100
5025B	1/2 in	T7625614	191923	Swiveling, Round Eye Bolt Snap	Polished	Bulk, UPC Tag	5/8 in	3-1/16 in	1/4 in	40 lb	0.05 lb	10	100

## Stainless Steel Snaps

- Typical uses include Tarp Covers, Key Rings, Gate Closures, Flagpoles, and Other Home, Farm, Recreational and Marine Applications
- Also Ideal for Pet Leashes and Tie-Outs
- DO NOT EXCEED THE WORKING LOAD LIMIT
- Do Not Use for Overhead Lifting or Hoisting



Figure No.	Trade Size	Catalog No.	UPC No. 020418	Style	Finish	Packaged	A Dim.	B Dim.	C Dim.	Working Load Limit	Weight Each	Shelf Pack	Case Pack
162S	-	T7631204	201332	Double Ended Bolt Snap	Polished	Bulk, UPC Tag	-	4 in	3/8 in	130 lb	0.14 lb	10	100
225S	1/2 in	T7631304	179907	Swiveling, Round Eye Bolt Snap	Polished	Bulk, UPC Tag	1/2 in	3-5/16 in	3/8 in	170 lb	0.10 lb	10	100
225S	3/4 in	T7631324	201349	Swiveling, Round Eye Bolt Snap	Polished	Bulk, UPC Tag	3/4 in	3-3/32 in	3/8 in	180 lb	0.11 lb	10	100
249S	3/8 in	T7631404	204647	Rigid, Round Eye Quick Snap	Polished	Bulk, UPC Tag	3/8 in	2-5/32 in	9/32 in	90 lb	0.04 lb	10	100
249S	5/8 in	T7631414	201356	Rigid, Round Eye Quick Snap	Polished	Bulk, UPC Tag	5/8 in	2-7/8 in	3/8 in	160 lb	0.11 lb	10	100
249S	3/4 in	T7631434	201363	Rigid, Round Eye Quick Snap	Polished	Bulk, UPC Tag	3/4 in	3-29/32 in	9/16 in	190 lb	0.24 lb	10	100
251S	11/16 in	T7631524	193514	Swiveling, Round Eye Quick Snap	Polished	Bulk, UPC Tag	11/16 in	3-11/16 in	7/16 in	220 lb	0.20 lb	10	100
251S	3/4 in	T7631534	201370	Swiveling, Round Eye Quick Snap	Polished	Bulk, UPC Tag	3/4 in	4-1/2 in	9/16 in	200 lb	0.31 lb	10	100
2311S	3/4 in	T7631604	201387	Latched, Snap Hook	Polished	Bulk, UPC Tag	3/4 in	4-1/16 in	5/8 in	400 lb	0.23 lb	10	100
2311S	1-1/8 in	T7631614	201394	Latched, Snap Hook	Polished	Bulk, UPC Tag	1-1/8 in	4-21/32 in	23/32 in	400 lb	0.34 lb	10	50
5013S	1/2 in	T7631704	201400	Swiveling, Round Eye Trigger Snap	Polished	Bulk, UPC Tag	1/2 in	2-15/32 in	7/16 in	80 lb	0.10 lb	10	100
5025S	1/2 in	T7631804	179983	Swiveling, Round Eye Bolt Snap	Polished	Bulk, UPC Tag	1/2 in	2-15/16 in	1/4 in	50 lb	0.08 lb	10	100

ACCESSORIES

## Aluminum Spring Snap Link

- Aluminum Spring Snap
- Shipped in Assorted Colors
- DO NOT EXCEED THE WORKING LOAD LIMIT
- Do Not Use for Overhead Lifting or Hoisting
- Do Not Use to Support Human Weight, for Playground or Athletic Equipment, or as a Safety Device



Trade Size	Catalog No.	UPC No. 020418	Finish	Opening	Inside Length	Inside Width	Overall Length	Packaged	Working Load Limit	Weight Each	Shelf Pack	Case Pack
5/16 in	T7645000	206092	Various	0.50 in	2.50 in	1.125 in	3.125 in	Bulk, UPC Tag	75 lb	0.05 lb	10	100



## Spring Snap Links

- Ideal for Hanging Keys and Other Utility Items From Belt
- Fast and Easy to Connect and Disconnect
- Do Not Use to Support Human Weight, for Playground or Athletic Equipment, or as a Safety Device

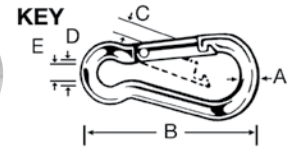

Figure No.	Trade Size	Catalog No.	UPC No. 020418	Finish	Mat. Dia. (A)	Length (B)	Opening (C)	Eye Dia. (D)	Inside Width (E)	Packaged	Working Load Limit	Weight Each	Shelf Pack	Case Pack
2450	1/4 in	T7645006V	269837	Zinc Plated	0.19 in	2.03 in	0.27 in	0.34 in	0.21 in	Bulk, UPC Tag	80 lb	0.03 lb	10	100
2450	5/16 in	T7645016V	269868	Zinc Plated	0.23 in	2.40 in	0.28 in	0.34 in	0.23 in	Bulk, UPC Tag	130 lb	0.05 lb	10	100
2450	3/8 in	T7645026V	269776	Zinc Plated	0.27 in	2.74 in	0.35 in	0.43 in	0.33 in	Bulk, UPC Tag	160 lb	0.10 lb	10	100
2450	7/16 in	T7645036V	269844	Zinc Plated	0.31 in	3.22 in	0.46 in	0.48 in	0.30 in	Bulk, UPC Tag	200 lb	0.15 lb	10	100
2450	1/2 in	T7645046V	269790	Zinc Plated	0.35 in	3.53 in	0.46 in	0.56 in	0.40 in	Bulk, UPC Tag	230 lb	0.20 lb	10	100
2450	5/8 in	T7645066V	269899	Zinc Plated	0.38 in	3.92 in	0.50 in	0.61 in	0.41 in	Bulk, UPC Tag	280 lb	0.28 lb	10	100
2450	3/4 in	T7645068V	269851	Zinc Plated	0.42 in	4.76 in	0.64 in	0.76 in	0.47 in	Bulk, UPC Tag	350 lb	0.30 lb	10	50
2450	1 in	T7645074V	269882	Zinc Plated	0.47 in	5.60 in	0.82 in	0.88 in	0.50 in	Bulk, UPC Tag	400 lb	0.59 lb	10	50

## Quick Links

- For Fast and Easy Connections Between Two Lengths of Chain
- Do Not Use to Support Human Weight, for Playground or Athletic Equipment, or as a Safety Device

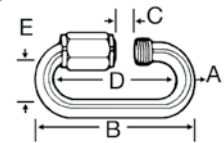
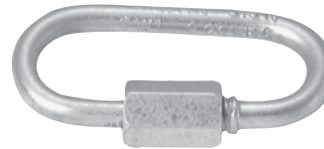

Figure No.	Trade Size	Catalog No.	UPC No. 020418	Finish	Mat. Dia. (A)	Length (B)	Opening (C)	Inside Length (D)	Inside Width (E)	Packaged	Working Load Limit	Weight Each	Shelf Pack	Case Pack
7350	1/8 in	T7645106V	269806	Zinc Plated	0.13 in	1.40 in	0.20 in	1.16 in	0.40 in	Bulk, UPC Tag	220 lb	0.02 lb	10	100
7350	3/16 in	T7645116V	269875	Zinc Plated	0.20 in	1.85 in	0.29 in	1.60 in	0.53 in	Bulk, UPC Tag	660 lb	0.05 lb	10	100
7350	1/4 in	T7645126V	269813	Zinc Plated	0.24 in	2.31 in	0.34 in	1.85 in	0.58 in	Bulk, UPC Tag	880 lb	0.08 lb	10	100
7350	5/16 in	T7645136V	269783	Zinc Plated	0.31 in	2.92 in	0.41 in	2.31 in	0.74 in	Bulk, UPC Tag	1760 lb	0.15 lb	10	100
7350	3/8 in	T7645146V	269820	Zinc Plated	0.35 in	3.21 in	0.45 in	2.53 in	0.81 in	Bulk, UPC Tag	2200 lb	0.24 lb	10	100
7350	1/2 in	T7645156V	269905	Zinc Plated	0.47 in	4.17 in	0.57 in	3.27 in	0.94 in	Bulk, UPC Tag	3300 lb	0.50 lb	10	50

## Stainless Steel Spring Snap Links

- Ideal for Hanging Keys and Other Utility Items From Belt
- Fast and Easy to Connect and Disconnect
- Do Not Use to Support Human Weight, for Playground or Athletic Equipment, or as a Safety Device

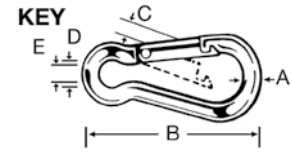
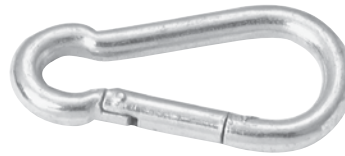

Figure No.	Trade Size	Catalog No.	UPC No. 020418	Finish	Mat. Dia. (A)	Length (B)	Opening (C)	Eye Dia. (D)	Inside Width (E)	Packaged	Working Load Limit	Weight Each	Shelf Pack	Case Pack
2450	1/4 in	T7630406	193415	Polished	0.226 in	2.38 in	0.34 in	0.37 in	0.29 in	Bulk, UPC Tag	160 lb	0.06 lb	10	100
2450	5/16 in	T7630416	193422	Polished	0.305 in	3.15 in	0.45 in	0.51 in	0.40 in	Bulk, UPC Tag	200 lb	0.14 lb	10	100
2450	3/8 in	T7630426	193439	Polished	0.340 in	3.54 in	0.45 in	0.57 in	0.45 in	Bulk, UPC Tag	260 lb	0.20 lb	10	100
2450	7/16 in	T7630436	193446	Polished	0.385 in	3.94 in	0.51 in	0.66 in	0.46 in	Bulk, UPC Tag	320 lb	0.28 lb	10	100
2450	1/2 in	T7630446	193453	Polished	0.420 in	4.69 in	0.66 in	0.75 in	0.60 in	Bulk, UPC Tag	450 lb	0.42 lb	10	50

## Stainless Steel Quick Links

- For Fast and Easy Connections Between Two Lengths of Chain
- Do Not Use to Support Human Weight, for Playground or Athletic Equipment, or as a Safety Device

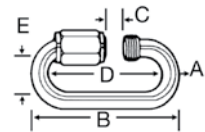
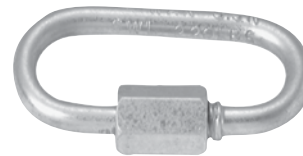

Figure No.	Trade Size	Catalog No.	UPC No. 020418	Finish	Mat. Dia. (A)	Length (B)	Opening (C)	Inside Length (D)	Inside Width (E)	Packaged	Working Load Limit	Weight Each	Shelf Pack	Case Pack
7350	1/8 in	T7630506	193460	Polished	0.137 in	1.45 in	0.19 in	1.18 in	0.41 in	Bulk, UPC Tag	220 lb	0.02 lb	10	100
7350	3/16 in	T7630526	193477	Polished	0.195 in	1.94 in	0.24 in	1.56 in	0.53 in	Bulk, UPC Tag	660 lb	0.04 lb	10	100
7350	1/4 in	T7630536	193484	Polished	0.230 in	2.28 in	0.30 in	1.83 in	0.60 in	Bulk, UPC Tag	880 lb	0.08 lb	10	100
7350	5/16 in	T7630546	193491	Polished	0.310 in	2.93 in	0.38 in	2.34 in	0.73 in	Bulk, UPC Tag	1540 lb	0.18 lb	10	100
7350	3/8 in	T7630556	193507	Polished	0.350 in	3.24 in	0.39 in	2.56 in	0.78 in	Bulk, UPC Tag	1540 lb	0.24 lb	10	100

ACCESSORIES





## Die Cast Zinc Pulleys

- Features One Piece Cast Construction and Triple Copper/Nickel Plating
- Solid Brass or Brass Plated Sheaves
- For Rope Applications in Awnings, Flagpoles and Other Light Duty Applications
- DO NOT EXCEED THE WORKING LOAD LIMIT
- Do Not Use for Overhead Lifting or Hoisting
- Do Not Use to Support Human Weight, for Playground or Athletic Equipment, or as a Safety Device



ACCESSORIES

Figure No.	Trade Size	Catalog No.	UPC No. 020418	Style	Finish	Rope Size	Sheave Size - OD	Eye Size	Packaged	Working Load Limit	Weight Each	Shelf Pack	Case Pack
0173	1/2 in	T7655052	191978	Swivel Eye, Single Sheave	Nickel Plated	3/16	1/2 in	5/16 in	Bulk, UPC Tag	25 lb	0.06 lb	10	100
0174	1/2 in	T7655062	191985	Rigid Eye, Single Sheave	Nickel Plated	3/16	1/2 in	3/16 in	Bulk, UPC Tag	30 lb	0.05 lb	10	100
0173	3/4 in	T7655002	179990	Swivel Eye, Single Sheave	Nickel Plated	1/4 in	3/4 in	5/16 in	Bulk, UPC Tag	25 lb	0.05 lb	10	100
0174	3/4 in	T7655100	201417	Rigid Eye, Single Sheave	Nickel Plated	1/4 in	3/4 in	3/16 in	Bulk, UPC Tag	30 lb	0.06 lb	10	100
0176	3/4 in	T7655202	201424	Rigid Eye, Double Sheave	Nickel Plated	1/4 in	3/4 in	3/16 in	Bulk, UPC Tag	40 lb	0.10 lb	10	100
0173	1 in	T7655012	180002	Swivel Eye, Single Sheave	Nickel Plated	5/16 in	1 in	5/16 in	Bulk, UPC Tag	30 lb	0.13 lb	10	100
0174	1 in	T7655112	180040	Rigid Eye, Single Sheave	Nickel Plated	5/16 in	1 in	7/32 in	Bulk, UPC Tag	55 lb	0.12 lb	10	100
0176	1 in	T7655212	201431	Rigid Eye, Double Sheave	Nickel Plated	5/16 in	1 in	7/32 in	Bulk, UPC Tag	55 lb	0.20 lb	10	100
0178	1 in	T7655312	180101	Swivel Eye, Double Sheave	Nickel Plated	5/16 in	1 in	5/16 in	Bulk, UPC Tag	25 lb	0.24 lb	10	100
0173	1-1/4 in	T7655022	180019	Swivel Eye, Single Sheave	Nickel Plated	3/8 in	1-1/4 in	5/8 in	Bulk, UPC Tag	50 lb	0.30 lb	10	100
0174	1-1/4 in	T7655120	180057	Rigid Eye, Single Sheave	Nickel Plated	3/8 in	1-1/4 in	3/8 in	Bulk, UPC Tag	110 lb	0.28 lb	10	100
0173	1-1/2 in	T7655032	191961	Swivel Eye, Single Sheave	Nickel Plated	3/8 in	1-1/2 in	5/8 in	Bulk, UPC Tag	50 lb	0.30 lb	10	50
0174	1-1/2 in	T7655132	191992	Rigid Eye, Single Sheave	Nickel Plated	3/8 in	1-1/2 in	3/8 in	Bulk, UPC Tag	110 lb	0.27 lb	10	50
0176	1-1/2 in	T7655222	192005	Rigid Eye, Double Sheave	Nickel Plated	3/8 in	1-1/2 in	3/8 in	Bulk, UPC Tag	90 lb	0.44 lb	10	50
0173	2 in	T7655042	180026	Swivel Eye, Single Sheave	Nickel Plated	1/2 in	2 in	5/8 in	Bulk, UPC Tag	55 lb	0.47 lb	10	50
0174	2 in	T7655142	180064	Rigid Eye, Single Sheave	Nickel Plated	1/2 in	2 in	15/32 in	Bulk, UPC Tag	125 lb	0.50 lb	10	50

## Heavy Duty Steel Pulleys

- Steel Body and Die-Cast Zinc Sheave
- Zinc Plated to Protect Against Rust and Corrosion
- Powder Metal Bushing to Extend Pulley Life and Provide Smooth Operation
- For Rope Up to 3/8" or 1/2" As Noted
- Working Load Limit Stamped on Pulley Body
- For Indoor or Outdoor Use
- Mount Wall and Ceiling Pulleys with 4D or 6D Nails or #4 X 3/4" Screws
- DO NOT EXCEED THE WORKING LOAD LIMIT
- Do Not Use for Overhead Lifting or Hoisting

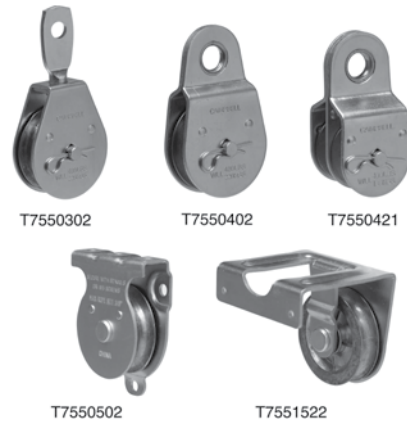

Trade Size	Catalog No.	UPC No. 020418	Style	Finish	Rope Size	Sheave Size - OD	Packaged	Working Load Limit	Weight Each	Shelf Pack	Case Pack
1-1/2 in	T7550301	193361	Swivel Eye, Single Sheave	Zinc Plated	3/8 in	1-1/2 in	Bulk, UPC Tag	420 lb	0.32 lb	5	50
1-1/2 in	T7550401	193392	Fixed Eye, Single Sheave	Zinc Plated	3/8 in	1-1/2 in	Bulk, UPC Tag	420 lb	0.18 lb	5	50
1-1/2 in	T7550421	193385	Fixed Eye, Double Sheave	Zinc Plated	3/8 in	1-1/2 in	Bulk, UPC Tag	400 lb	0.30 lb	5	50
1-1/2 in	T7550501	300028	Wall/Ceil Mount, Single Sheave	Zinc Plated	3/8 in	1-1/2 in	Bulk, UPC Tag	100 lb	0.33 lb	5	50
2 in	T7550302	193378	Swivel Eye, Single Sheave	Zinc Plated	3/8 in	2 in	Bulk, UPC Tag	480 lb	0.22 lb	5	50
2 in	T7550402	193408	Fixed Eye, Single Sheave	Zinc Plated	3/8 in	2 in	Bulk, UPC Tag	480 lb	0.26 lb	5	50
2 in	T7550502	300011	Wall/Ceil Mount, Single Sheave	Zinc Plated	3/8 in	2 in	Bulk, UPC Tag	100 lb	0.46 lb	5	50
2 in	T7551522	300004	Joist Mount, Single Sheave	Zinc Plated	3/8 in	2 in	Bulk, UPC Tag	100 lb	0.45 lb	5	50
2-1/2 in	T7550303	206085	Swivel Eye, Single Sheave	Zinc Plated	3/8 in	2-1/2 in	Bulk, UPC Tag	550 lb	0.62 lb	5	25
2-1/2 in	T7550403	300035	Fixed Eye, Single Sheave	Zinc Plated	3/8 in	2-1/2 in	Bulk, UPC Tag	550 lb	0.70 lb	5	25
3 in	T7550304	300059	Swivel Eye, Single Sheave	Zinc Plated	1/2 in	3 in	Bulk, UPC Tag	650 lb	1.05 lb	5	25
3 in	T7550404	300042	Fixed Eye, Single Sheave	Zinc Plated	1/2 in	3 in	Bulk, UPC Tag	650 lb	1.03 lb	5	25

## Rope Clamps

- Used to Create Loop End Termination on Fiber Rope



Catalog No.	UPC No. 020418	Style	Finish	Rope Size	Packaged	Weight Each	Shelf Pack	Case Pack
B7679034	157189	Rope Clamp, 2 per Bag	Zinc Plated	1/2 in	Bagged	0.10 lb	10	100
B7679035	157196	Rope Clamp & Thimble	Zinc Plated	1/4 in - 3/8 in	Bagged	0.09 lb	10	100

## Rope Cleats

- For Fastening Rope for Boats, Awnings, Etc.



Figure No.	Trade Size	Catalog No.	UPC No. 020418	Finish	Length	Packaged	Weight Each	Shelf Pack	Case Pack
4015	2-1/2 in	T7655402	192012	Nickel Plated	2-1/2 in	Bulk, UPC Tag	0.04 lb	10	100
4015	2-1/2 in	T7655404	193354	Brass	2-1/2 in	Bulk, UPC Tag	0.03 lb	10	100
4015	4-1/2 in	T7655412	192029	Nickel Plated	4-1/2 in	Bulk, UPC Tag	0.08 lb	10	100
4015	6 in	T7655422	193347	Nickel Plated	6 in	Bulk, UPC Tag	0.14 lb	10	100



## Footman Loops

- Die Cast Construction



Trade Size	Catalog No.	UPC No. 020418	Style	Finish	Overall Length	Inside Loop Length	Diameter	Packaged	Weight Each	Shelf Pack	Case Pack
1/2 in	T7691800	211836	Rope Loop	Nickel Plated	2-3/4 in	1-3/4 in	1/4 in	Bulk, UPC Tag	0.04 lb	10	100
1 in	T7691801	211843	Strap Loop	Nickel Plated	2-5/8 in	1 in	1/4 in	Bulk, UPC Tag	0.04 lb	10	100
1-1/4 in	T7691802	211850	Strap Loop	Nickel Plated	2-3/4 in	1-3/8 in	1/4 in	Bulk, UPC Tag	0.03 lb	10	100
1-1/2 in	T7691803	211867	Strap Loop	Nickel Plated	3-1/8 in	1-5/8 in	1/4 in	Bulk, UPC Tag	0.04 lb	10	100
2 in	T7691804	211829	Strap Loop	Nickel Plated	3-3/4 in	2-1/8 in	5/16 in	Bulk, UPC Tag	0.06 lb	10	100

## Ferrules and Stops

- Insert Ferrule(s) Onto Cable, Form Loop and Insert Thimble (If Desired)
- Use a Proper Swaging Tool (Not a Hammer) to Make Swages.
- Match Ferrule, Thimble and Stop Size to Size of Cable
- If Used on Coated Cable, Remove the Coating From the Assembly Area
- Follow Assembly Instructions Carefully
- Made From Aluminum or Copper

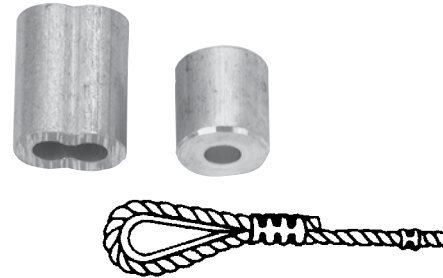

Trade Size	Catalog No.	UPC No. 020418	Material	For Cable Diameter	Style	Packaged	Weight Each	Shelf Pack	Case Pack
1/16 in	7670804	288142	Aluminum	1/16 in	Ferrules	Bulk	0.01 lb	50	250
1/16 in	B7675404	288197	Aluminum	1/16 in	Ferrules (2) and Stops (2)	Bagged	0.01 lb	10	100
1/16 in	T7670904*	240720	Copper	1/16 in	Ferrules	Bulk	0.01 lb	100	1000
3/32 in	7670814	288159	Aluminum	3/32 in	Ferrules	Bulk	0.01 lb	50	250
3/32 in	B7675414	288203	Aluminum	3/32 in	Ferrules (2) and Stops (2)	Bagged	0.02 lb	10	100
3/32 in	T7670914*	240768	Copper	3/32 in	Ferrules	Bulk	0.01 lb	100	1000
1/8 in	7670824	288166	Aluminum	1/8 in	Ferrules	Bulk	0.01 lb	50	250
1/8 in	B7675424	288210	Aluminum	1/8 in	Ferrules (2) and Stops (2)	Bagged	0.02 lb	10	100
1/8 in	T7670924*	240751	Copper	1/8 in	Ferrules	Bulk	0.02 lb	50	500
3/16 in	7670844	288173	Aluminum	3/16 in	Ferrules	Bulk	0.02 lb	50	250
3/16 in	B7675444	288227	Aluminum	3/16 in	Ferrules (2) and Stops (2)	Bagged	0.04 lb	10	100
3/16 in	T7670944*	240744	Copper	3/16 in	Ferrules	Bulk	0.05 lb	25	250
1/4 in	7670854	288180	Aluminum	1/4 in	Ferrules	Bulk	0.03 lb	50	250
1/4 in	B7675454	288234	Aluminum	1/4 in	Ferrules (2) and Stops (2)	Bagged	0.09 lb	10	100
1/4 in	T7670954*	240737	Copper	1/4 in	Ferrules	Bulk	0.08 lb	25	250

\* Copper Ferrules are Zinc Plated

## Swaging Tool

- For Securing Ferrules and Stops onto Wire Rope or Cable
- Do Not Swage on Coated Cable, Remove Coating From the Assembly Area
- Read All Assembly and Maintenance Instructions on Tool Package
- Designed for Use on 1/16" to 3/16" Sized Ferrules and Stops



Catalog No.	UPC No. 020418	Overall Length	Packaged	Weight Each	Shelf Pack
7679038	224010	18 in	Boxed	5.90 lb	2

## Wire Rope Clips and Thimbles

- If Used on Coated Cable, Remove the Coating From the Assembly Area
- Follow Assembly Instructions

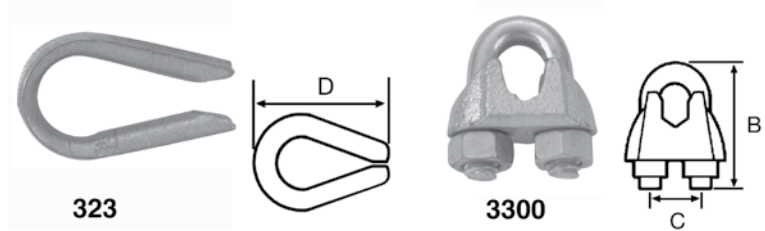

Figure No.	Trade Size	Catalog No.	UPC No. 020418	Style	Finish	Packaged	B Dim.	C Dim.	D Dim.	Weight Each	Shelf Pack	Case Pack
3300	1/16 in	<b>T7670409</b>	192586	Wire Rope Clip	Electro-Galvanized	Bulk, UPC Tag	7/8 in	7/16 in	-	0.02 lb	10	100
3300	1/8 in	<b>B7675109</b>	166846	Wire Rope Clips (2) w/Thimble (1)	Electro-Galvanized	Bagged	1-1/2 in	1/2 in	1-3/4 in	0.18 lb	10	100
3300	1/8 in	<b>T7670419</b>	201691	Wire Rope Clip	Electro-Galvanized	Bulk, UPC Tag	1 in	1/2 in	-	0.03 lb	10	100
323	1/8 in	<b>T7670609</b>	201769	Wire Rope Thimble	Electro-Galvanized	Bulk, UPC Tag	-	-	1-3/4 in	0.03 lb	10	100
3300	3/16 in	<b>B7675119</b>	166853	Wire Rope Clips (2) w/Thimble (1)	Electro-Galvanized	Bagged	1-1/16 in	9/16 in	1-3/4 in	0.19 lb	10	100
3300	3/16 in	<b>T7670429</b>	201707	Wire Rope Clip	Electro-Galvanized	Bulk, UPC Tag	1-1/16 in	9/16 in	-	0.05 lb	10	100
323	3/16 in	<b>T7670619</b>	201776	Wire Rope Thimble	Electro-Galvanized	Bulk, UPC Tag	-	-	1-3/4 in	0.02 lb	10	100
3300	1/4 in	<b>B7675129</b>	166860	Wire Rope Clips (2) w/Thimble (1)	Electro-Galvanized	Bagged	1-1/2 in	11/16 in	1-7/8 in	0.20 lb	10	100
3300	1/4 in	<b>T7670439</b>	201714	Wire Rope Clip	Electro-Galvanized	Bulk, UPC Tag	1-1/2 in	11/16 in	-	0.10 lb	10	100
323	1/4 in	<b>T7670629</b>	201783	Wire Rope Thimble	Electro-Galvanized	Bulk, UPC Tag	-	-	1-7/8 in	0.03 lb	10	100
3300	5/16 in	<b>T7670449</b>	201721	Wire Rope Clip	Electro-Galvanized	Bulk, UPC Tag	1-1/2 in	11/16 in	-	0.13 lb	10	100
323	5/16 in	<b>T7670639</b>	201790	Wire Rope Thimble	Electro-Galvanized	Bulk, UPC Tag	-	-	2-3/32 in	0.04 lb	10	100
3300	3/8 in	<b>T7670459</b>	201738	Wire Rope Clip	Electro-Galvanized	Bulk, UPC Tag	2 in	7/8 in	-	0.22 lb	10	10
323	3/8 in	<b>T7670649</b>	201806	Wire Rope Thimble	Electro-Galvanized	Bulk, UPC Tag	-	-	2-1/4 in	0.06 lb	10	100
3300	1/2 in	<b>T7670479</b>	201745	Wire Rope Clip	Electro-Galvanized	Bulk, UPC Tag	2-1/2 in	1 in	-	0.31 lb	5	50
323	1/2 in	<b>T7670659</b>	201813	Wire Rope Thimble	Electro-Galvanized	Bulk, UPC Tag	-	-	2-1/2 in	0.11 lb	5	50
3300	5/8 in	<b>T7670489</b>	201752	Wire Rope Clip	Electro-Galvanized	Bulk, UPC Tag	2-3/4 in	1-3/16 in	-	0.26 lb	5	50
323	5/8 in	<b>T7670669</b>	201820	Wire Rope Thimble	Electro-Galvanized	Bulk, UPC Tag	-	-	2-7/8 in	0.34 lb	5	50
3300	3/4 in	<b>T7670499</b>	180460	Wire Rope Clip	Electro-Galvanized	Bulk, UPC Tag	3-1/16 in	1-11/32 in	-	0.60 lb	5	50



## Stainless Steel Wire Rope Clips & Light Duty Thimbles

- Follow Assembly Instructions



Trade Size	Catalog No.	UPC No. 020418	Style	Finish	Packaged	Weight Each	Shelf Pack	Case Pack
1/8 in	T7633002	204692	Wire Rope Clip	Polished	Bulk, UPC Tag	0.03 lb	10	100
3/16 in	T7633003	204715	Wire Rope Clip	Polished	Bulk, UPC Tag	0.05 lb	10	100
1/4 in	T7633004	204722	Wire Rope Clip	Polished	Bulk, UPC Tag	0.08 lb	10	100
1/16 in - 1/8 in	T7637502	238147	Wire Rope Thimble	Polished	Bulk, UPC Tag	0.02 lb	10	100
3/16 in	T7637503	204746	Wire Rope Thimble	Polished	Bulk, UPC Tag	0.02 lb	10	100
1/4 in	T7637504	204753	Wire Rope Thimble	Polished	Bulk, UPC Tag	0.02 lb	10	100

ACCESSORIES

## Eye & Eye Swivels (Import)

- Forged Steel
- These Swivels ARE NOT Designed to Swivel Under Load
- UPC Tagged
- DO NOT EXCEED THE WORKING LOAD LIMIT



Trade Size	Catalog No.	UPC No. 020418	Finish	A Dim.	B Dim.	C Dim.	D Dim.	E Dim.	F Dim.	Working Load Limit	Weight Each	Shelf Pack	Case Pack
3/16 in	T9630335	211560	Galvanized	0.20 in	0.70 in	0.81 in	2.52 in	0.62 in	0.64 in	700 lb	0.11 lb	5	50
1/4 in	T9630435	211577	Galvanized	0.25 in	0.73 in	1.02 in	3.00 in	0.65 in	0.69 in	850 lb	0.19 lb	5	50
5/16 in	T9630535	211584	Galvanized	0.33 in	0.97 in	1.18 in	3.64 in	0.77 in	0.84 in	1250 lb	0.37 lb	5	50
3/8 in	T9630635	211591	Galvanized	0.44 in	1.20 in	1.34 in	4.20 in	1.00 in	1.02 in	2250 lb	0.69 lb	5	25
1/2 in	T9630835	211607	Galvanized	0.55 in	1.46 in	1.88 in	5.44 in	1.16 in	1.28 in	3600 lb	1.39 lb	5	25

## Anchor Shackles, Screw Pin (Import) Consumer Grade

- Carbon Steel
- DO NOT EXCEED THE WORKING LOAD LIMIT
- Do Not Use for Overhead Lifting or Hoisting



Trade Size	Catalog No.	UPC No. 020418	Style	Finish	Working Load Limit	Weight Each	Shelf Pack	Case Pack
3/16 in	T9600335	201509	Screw Pin	Zinc Plated	100 lb	0.05 lb	10	100
1/4 in	T9600435	201516	Screw Pin	Zinc Plated	400 lb	0.08 lb	10	100
5/16 in	T9600535	201523	Screw Pin	Zinc Plated	700 lb	0.15 lb	10	100
3/8 in	T9600635	201530	Screw Pin	Zinc Plated	1000 lb	0.28 lb	10	100
1/2 in	T9600835	201547	Screw Pin	Zinc Plated	2000 lb	0.60 lb	5	50
5/8 in	T9601035	201554	Screw Pin	Zinc Plated	3000 lb	1.40 lb	5	20
3/4 in	T9601235	201561	Screw Pin	Zinc Plated	4000 lb	2.40 lb	5	20
1 in	T9601635	201578	Screw Pin	Zinc Plated	5000 lb	5.00 lb	2	10

## Anchor Shackles, Screw Pin (Import) Industrial Grade

- Drop-Forged Carbon Steel
- DO NOT EXCEED THE WORKING LOAD LIMIT

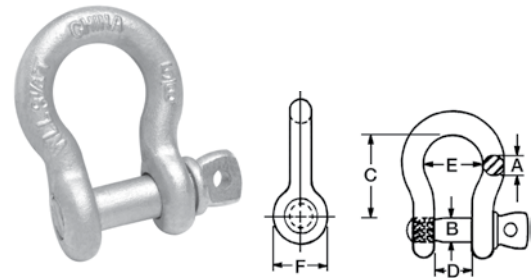

Trade Size	Catalog No.	UPC No. 020418	A Dim.	B Dim.	C Dim.	D Dim.	E Dim.	F Dim.	Finish	Working Load Limit (Short Tons)	Weight Each	Shelf Pack	Case Pack
3/16 in	T9640335	211706	0.19 in	0.25 in	0.87 in	0.37 in	0.63 in	0.56 in	Galvanized	1/3 T	0.06 lb	10	100
1/4 in	T9640435	211683	0.25 in	0.31 in	1.12 in	0.50 in	0.78 in	0.69 in	Galvanized	1/2 T	0.11 lb	10	100
5/16 in	T9640535	211676	0.32 in	0.37 in	1.20 in	0.54 in	0.83 in	0.86 in	Galvanized	3/4 T	0.18 lb	10	100
3/8 in	T9640635	211669	0.38 in	0.43 in	1.44 in	0.67 in	1.00 in	1.05 in	Galvanized	1 T	0.32 lb	10	100
1/2 in	T9640835	211652	0.50 in	0.62 in	1.86 in	0.86 in	1.30 in	1.20 in	Galvanized	2 T	0.69 lb	5	50
5/8 in	T9641035	211645	0.62 in	0.75 in	2.44 in	1.06 in	1.56 in	1.52 in	Galvanized	3-1/4 T	1.50 lb	25	25
3/4 in	T9641235	211621	0.75 in	0.87 in	2.80 in	1.30 in	2.00 in	1.85 in	Galvanized	4-3/4 T	2.30 lb	15	15
7/8 in	T9641435	211638	0.90 in	1.00 in	3.20 in	1.43 in	2.15 in	2.00 in	Galvanized	6-1/2 T	3.35 lb	10	10
1 in	T9641635	211614	1.00 in	1.12 in	3.75 in	1.68 in	2.55 in	2.37 in	Galvanized	8-1/2 T	5.20 lb	5	5

## Turnbuckles, Forged (Import)

- Drop-Forged Carbon Steel
- Galvanized Finish
- 5 to 1 Design Factor
- Turnbuckles are Designed for a Static Load
- In Loads Where There is Vibration, Lock Nuts (Jam Nuts) Should be Used to Prevent the Connection from Turning or Loosening
- UPC Tagged
- DO NOT EXCEED THE WORKING LOAD LIMIT

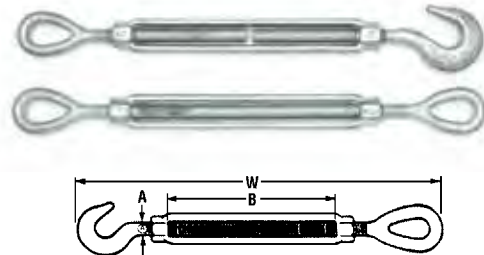

Trade Size	Catalog No.	UPC No. 020418	Style	Thread Diameter (A)	Take Up (B)	Closed Position Length (W)	Working Load Limit	Weight Each
3/8 in x 6 in	T9620108	289446	Hook & Eye	3/8 in	6 in	11-7/8 in	1000 lb	0.78 lb
1/2 in x 9 in	T9620115	289378	Hook & Eye	1/2 in	9 in	16-5/8 in	1500 lb	1.85 lb
5/8 in x 9 in	T9620121	289385	Hook & Eye	5/8 in	9 in	18-1/2 in	2300 lb	3.13 lb
5/8 in x 12 in	T9620122	289392	Hook & Eye	5/8 in	12 in	21-1/2 in	2300 lb	3.78 lb
3/8 in x 6 in	T9620308	289408	Eye & Eye	3/8 in	6 in	12 in	1200 lb	0.76 lb
1/2 in x 9 in	T9620315	289415	Eye & Eye	1/2 in	9 in	17 in	2200 lb	1.13 lb
5/8 in x 12 in	T9620322	289422	Eye & Eye	5/8 in	12 in	21-5/8 in	3500 lb	3.42 lb

ACCESSORIES



## Eye Grab Hooks, Grade 43, (Import)

- Grade 43 Forged Steel
- Grab Hooks Are Designed to Grab a Chain Link and Hold it in Place
- DO NOT EXCEED THE WORKING LOAD LIMIT



Trade Size	Catalog No.	UPC No. 020418	Hook Style	Finish	Working Load Limit	Weight Each	Shelf Pack	Case Pack
1/4 in	T9001424	222139	Eye	Zinc Plated	2600 lb	0.34 lb	10	100
5/16 in	T9001524	222146	Eye	Zinc Plated	3900 lb	0.55 lb	10	50
3/8 in	T9001624	222153	Eye	Zinc Plated	5400 lb	0.90 lb	10	50
1/2 in	T9001824	222122	Eye	Zinc Plated	9200 lb	1.80 lb	5	20

## Clevis Grab Hooks, Grade 43, (Import)

- Grade 43 Forged Steel
- Grab Hooks Are Designed to Grab a Chain Link and Hold it in Place
- Hooks are Sized by the Material Diameter of the Chain That They Engage. Make Sure the Hook Size and Chain Diameter are Compatible Before Attaching to Load
- DO NOT EXCEED THE WORKING LOAD LIMIT



Trade Size	Catalog No.	UPC No. 020148	For Chain Size	Hook Style	Finish	Working Load Limit	Weight Each	Shelf Pack	Case Pack
1/4 in	T9501424	192678	1/4 in	Clevis	Zinc Plated	2600 lb	0.43 lb	10	100
5/16 in	T9501524	192685	5/16 in	Clevis	Zinc Plated	3900 lb	0.73 lb	10	50
3/8 in	T9501624	192692	3/8 in	Clevis	Zinc Plated	5400 lb	1.11 lb	10	50
1/2 in	T9501824	220661	1/2 in	Clevis	Zinc Plated	9200 lb	1.85 lb	5	20

## Clevis Grab Hooks, Grade 70, (Import)

- Forged Steel
- Transport Grade
- Grab Hooks Are Designed to Grab a Chain Link and Hold it in Place
- Hooks are Sized by the Material Diameter of the Chain That They Engage. Make Sure the Hook Size and Chain Diameter are Compatible Before Attaching to Load



Trade Size	Catalog No.	UPC No. 020418	For Chain Size	Hook Style	Finish	Working Load Limit	Weight Each	Shelf Pack	Case Pack
1/4 in	T9503315	289316	1/4 in	Clevis	Yellow Chromate	3150 lb	0.43 lb	10	100
5/16 in	T9503415	201974	5/16 in	Clevis	Yellow Chromate	4700 lb	0.71 lb	10	50
3/8 in	T9503515	201981	3/8 in	Clevis	Yellow Chromate	6600 lb	1.18 lb	5	25

## Eye Slip Hooks, Grade 43, (Import)

- UPC Tagged Forged Steel
- Slip Hooks Are Designed to Allow Chain to Slip Through the Hook
- DO NOT EXCEED THE WORKING LOAD LIMIT

Trade Size	Catalog No.	UPC No. 020418	Hook Style	Finish	Working Load Limit	Weight Each	Shelf Pack	Case Pack
1/4 in	T9101424	222177	Eye	Zinc Plated	2600 lb	0.40 lb	10	100
5/16 in	T9101524	222184	Eye	Zinc Plated	3900 lb	0.70 lb	10	50
3/8 in	T9101624	222191	Eye	Zinc Plated	5400 lb	1.00 lb	10	50
1/2 in	T9101824	222160	Eye	Zinc Plated	9200 lb	2.60 lb	5	20



## Clevis Slip Hooks, Grade 43, (Import)

- Grade 43 Forged Steel
- Slip Hooks Are Designed to Allow Chain to Slip Through the Hook
- Hooks are Sized by the Material Diameter of the Chain That They Engage. Make Sure the Hook Size and Chain Diameter are Compatible Before Attaching to Load



Clevis Slip Hook



Clevis Slip Hook with Latch

Trade Size	Catalog No.	UPC No. 020418	For Chain Size	Hook Style	Finish	Working Load Limit	Weight Each	Shelf Pack	Case Pack
1/4 in	T9401424	192647	1/4 in	Clevis	Zinc Plated	2600 lb	0.55 lb	5	100
1/4 in	T9700424	192081	1/4 in	Clevis w/ Latch	Zinc Plated	2600 lb	0.65 lb	5	50
5/16 in	T9401524	192654	5/16 in	Clevis	Zinc Plated	3900 lb	0.79 lb	5	50
5/16 in	T9700524	192098	5/16 in	Clevis w/ Latch	Zinc Plated	3900 lb	0.85 lb	5	50
3/8 in	T9401624	192661	3/8 in	Clevis	Zinc Plated	5400 lb	1.41 lb	5	50
3/8 in	T9700624	192104	3/8 in	Clevis w/ Latch	Zinc Plated	5400 lb	1.41 lb	5	30
1/2 in	T9401824	220654	1/2 in	Clevis	Zinc Plated	9200 lb	2.87 lb	5	15
1/2 in	T9700824	220647	1/2 in	Clevis w/ Latch	Zinc Plated	9200 lb	2.88 lb	5	15

## Clevis Slip Hooks, Grade 70, (Import)

- Forged Steel
- Transport Grade
- Slip Hooks Are Designed to Allow Chain to Slip Through the Hook
- Hooks are Sized by the Material Diameter of the Chain That They Engage. Make Sure the Hook Size and Chain Diameter are Compatible Before Attaching to Load



Trade Size	Catalog No.	UPC No. 020418	For Chain Size	Hook Style	Finish	Working Load Limit	Weight Each	Shelf Pack	Case Pack
1/4 in	T9504315	289323	1/4 in	Clevis w/ Latch	Yellow Chromate	3150 lb	0.65 lb	5	50
5/16 in	T9504415	289330	5/16 in	Clevis w/ Latch	Yellow Chromate	4700 lb	0.85 lb	5	50
3/8 in	T9504515	289347	3/8 in	Clevis w/ Latch	Yellow Chromate	6600 lb	1.41 lb	5	30



**FITTINGS**

Wire Rope Clips .....	74
Shackles .....	77
Hoist Hooks.....	85
Clevis Hooks .....	91
Latch Kits.....	95
Swivels .....	96
Thimbles .....	98
Sling Links .....	100
Eyebolts .....	102
Turnbuckles .....	105
Connecting Links .....	109

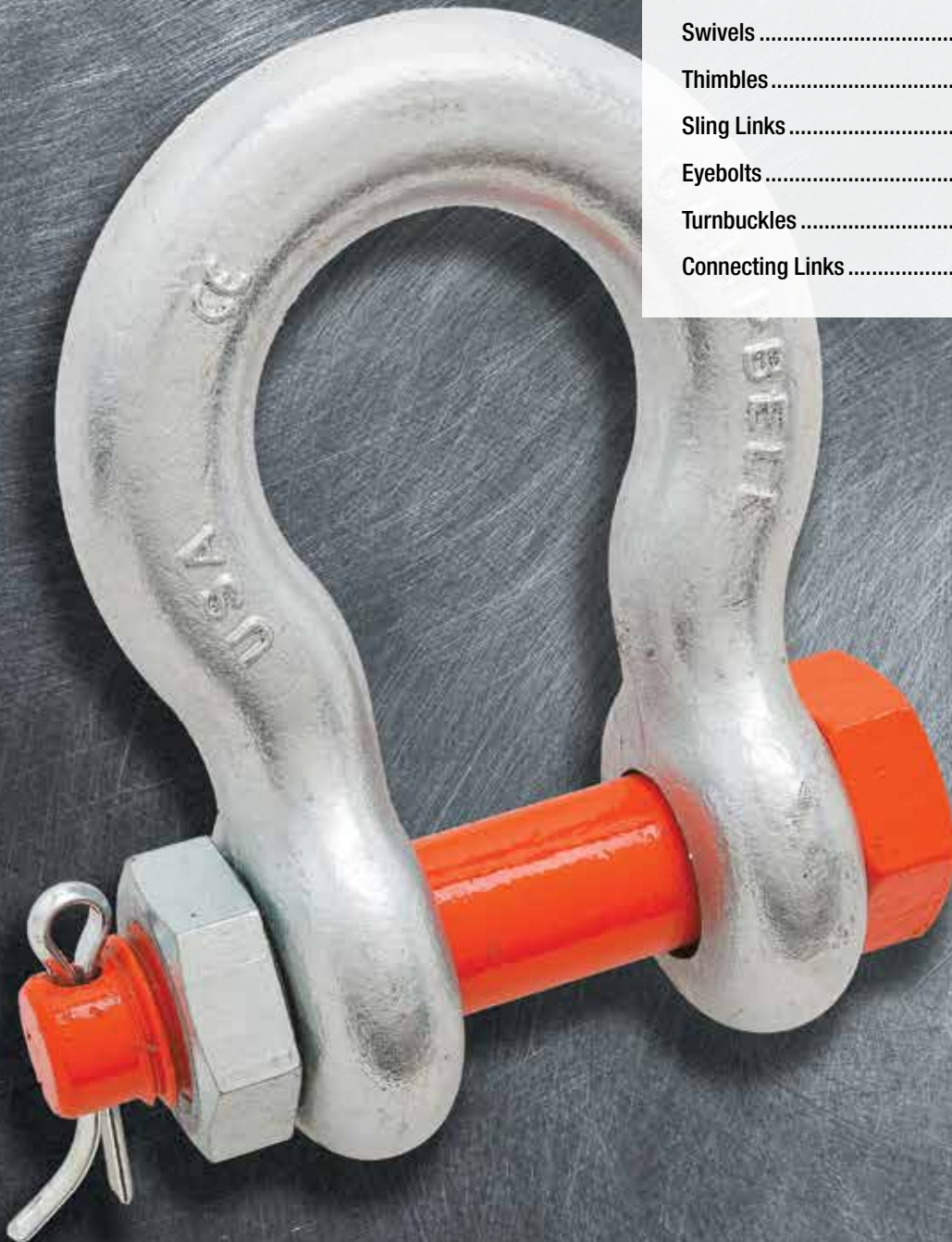

## Carbon and Alloy Steel Fittings Standards

Apex Tool Group forges Campbell® fittings under established quality control procedures. Dimensional tolerances meet standards adopted by the Drop Forging Association as outlined in “Standard Practices and Tolerances for Impression Die Forgings.” Working load limits for carbon and alloy steel fittings are based on predetermined design factors.

**Working Load Limit.** This is the related capacity. It is the maximum load which should ever be applied to the fittings in service, even when they are new.

**Proof Test.** This is a term designating a quality control tensile test applied to the fitting during or subsequent to the process of manufacture. It is the minimum force in pounds which the fitting has withstood in the condition and at the time it left the factory, under a test in which a constantly increasing force has been applied in direct tension to the fitting on a standard test machine.

**Ton.** Where “ton” is used in this catalog, it refers to short ton or 2,000 pounds, unless otherwise noted.

Key to Figure Number Designations	
S-Painted Blue	H- Heat Treated
G-Galvanized	ST-Stainless Steel
C-Carbon	V- Electro-polished
A-Alloy	Z- Zinc Plated
O-Painted Orange	

## Stainless Forged Fittings

Campbell® stainless forged fittings are used in place of carbon steel fittings for marine and food processing applications and where fittings are exposed to oxidizing acids, alkalis, neutral brines and detrimental temperatures.

They have won wide acceptance in aviation, boating, cements, chemicals, fertilizers, fishing, food processing, hydrodynamics and nuclear energy. Many are used in the fields of oceanography, petroleum, pulp and paper manufacturing, sewage disposal, textiles, water purification and yachting.

All stainless fittings are made of Type 316 stainless steel and have an electro-polished finish for improved stress relief, surface appearance and resistance to corrosion and chemical attack.

**WARNING:** Do not exceed Working Load Limit. Most of the fittings in this catalog are intended to be used in conjunction with other components in a load sustaining system. Care should be taken to select components of compatible type, grade, size and working load limit. Any abuse, misuse or alteration of the fitting may lessen the load that the fitting will sustain. Some examples of such changes and abuses are as follows:

- Twisting or side loading.
- Disfigurement.
- Deterioration of the fitting caused by strain, usage or corrosion.
- Shock loading.
- Use for a purpose other than that for which the particular fitting was intended.
- Use to carry a load in excess of the Working Load Limit.

A continual inspection program should be undertaken to discover gouges, distortion, cracks, elongation or stretching, spread in the throat, opening of hooks, severe wear, or other damage. Apex Tool Group does not accept any liability for damages which may result from alteration, misuse or abuse of the product or from use in excess of the Working Load Limit.

**NOTICE:** The product specifications and dimensions are as accurate as possible at the time of printing. However, because we are constantly improving the quality and design of our products, they can change without notice.

**ADVERTENCIA**

Para prevenir la posibilidad de una lesión personal sería:

- **NO EXCEDA** los límites de carga de las cadenas o componentes.
- **NO LA UTILICE** para cargar hacia arriba o para izar.
- **NO LA UTILICE** si la cadena o los componentes están visualmente distorsionados o gastados.

**WARNING**

To prevent the possibility of serious bodily injury:

- **DO NOT EXCEED** the working load limits for chain or components.
- **DO NOT USE** for overhead lifting or hoisting.
- **DO NOT USE** if the chain or components are visibly distorted or worn.

FITTINGS



## Wire Rope Clips

1000-G Forged, 3300 Malleable Iron, ST-43-V Stainless Steel



**READ AND UNDERSTAND THESE WARNINGS AND INSTRUCTIONS BEFORE USING THESE WIRE ROPE CLIPS.**

### IMPORTANT: Instructions For Use



1. Turn back specified amount of rope per clip size (shown in the table below) from the thimble. Install clip on base width from dead end of rope (U-bolt over dead end). Tighten nuts evenly to recommended torque.



2. Assemble the next clip as close to the loop as possible. Turn nuts alternately and firmly until the ropes make contact.

3. If any additional clips are required, they should be equally spaced between the first two. Tighten all nuts evenly on all clips to recommended torque (see table).

#### 4. IMPORTANT!

Apply the initial load to test the assembly. This load should be equal or greater weight than loads expected in use. Retighten nuts to recommended torque. Periodically, inspect assembly and tighten nuts to recommended torque.

The efficiency rating of a properly installed clip is based upon the catalog breaking strength of wire rope. The efficiency rating for clip sizes 1/8" through 7/8" is 80% and for sizes 1" through 2" is 90%. When a pulley is used in place of thimble for turning back the rope, one additional clip should be added.

The minimum number of clips shown in the table is based on using right or lang lay wire rope, 6x19 class, or 6x37 class, IWRC or fiber core, IPS or EIPS. If Seale construction or similar large outer wire type construction in the 6x19 class is being used for 1" and larger wire rope, one additional clip should be added.

The minimum number of clips shown in the table can be used with right regular lay wire rope, 8x19 class, fiber core IPS or IPS for 1-1/2" and smaller wire rope. The number of clips shown also applies to right regular lay wire rope 18x7 class, fiber core IPS or XIPS for 1-3/4" and smaller wire rope.

For classes of wire rope not mentioned, additional clips may be necessary to make a proper termination. Do not use on plastic coated wire rope.

Clip Size	Minimum No. of Clips	L Amount of Rope to Turn Back		Torque Foot Weight	
		in.	mm	lb	kg
1/8	2	3 1/2	89	5	2
3/16	2	4	102	8	4
1/4	2	5	127	15	7
5/16	2	5 1/2	140	30	14
3/8	2	6 1/2	165	45	20
7/16	2	7	178	65	30
1/2	3	11 1/2	292	65	30
9/16	3	12	305	95	43
5/8	3	12	305	95	43
3/4	4	18	457	130	59
7/8	4	19	483	225	102
1	5	26	660	225	102
1 1/8	6	34	864	225	102
1 1/4	7	44	1118	360	163
1 1/2	8	54	1372	360	163
1 3/4	8	61	1549	590	268
2	8	71	1803	750	341

**NOTE: If more clips are used than specified in the table above, the amount of rope turnback should be increased accordingly. The data above based on use of Campbell forged wire rope clips on new rope.**

### WARNING

- Failure to follow the Instructions For Use and these warnings may cause death or serious injury.
- Prepare wire rope end termination only as instructed.
- Do not use on plastic coated wire rope.
- Periodically inspect assembly for wear and abuse, and tighten nuts to recommended torque. If worn, distorted or damaged, discard and replace.
- Always stand clear of loads being lifted.



## Forged Wire Rope Clips, 1000-G

- Base is Drop-Forged Carbon Steel
- Hot Galvanized to ASTM A-153 to Resist Rust and Corrosion
- U-Bolts Are colored Blue for Identification Purposes and Use Heavy Duty Hex Nuts (UNC-2A)
- Designed to Meet Federal Specifications, FF-C-450, Type 1, Class 1
- Designed to Meet or Exceed All Requirements of ASME B30.26 Including: Identification, Ductility, Design Factor and Temperature
- Permanently Marked with Size and Manufacturer
- Sizes 1/4" and Above Marked with USA and Date Code
- Sizes 1/8" Through 1-1/4" Are Supplied Bagged and Unassembled
- Note: See Application and Warning Information

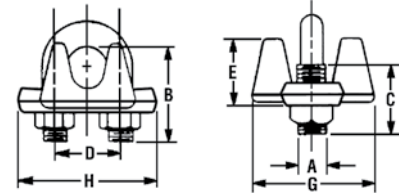

For Rope Diameter	Catalog No.	UPC No. 020481	Min. Clips Required	Clips Per Box	A Dim.	B Dim.	C Dim.	D Dim.	E Dim.	G Dim.	H Dim.	Weight Each
1/8 in	6990234	099908	2	100	7/32 in	3/4 in	7/16 in	9/16 in	7/16 in	29/32 in	1-1/16 in	0.08 lb
3/16 in	6990334	099915	2	100	1/4 in	15/16 in	9/16 in	5/8 in	1/2 in	15/16 in	1-1/8 in	0.10 lb
1/4 in	6990434	099922	2	100	5/16 in	1-1/32 in	5/8 in	23/32 in	21/32 in	1-1/8 in	1-7/16 in	0.18 lb
5/16 in	6990534	099939	2	100	3/8 in	1-5/16 in	13/16 in	7/8 in	3/4 in	1-5/16 in	1-11/16 in	0.32 lb
3/8 in	6990634	099946	2	75	7/16 in	1-1/2 in	15/16 in	1 in	29/32 in	1-9/16 in	1-15/16 in	0.48 lb
7/16 in	6990734	099953	2	50	1/2 in	2 in	1-1/8 in	1-1/8 in	1 in	1-11/16 in	2-1/4 in	0.72 lb
1/2 in	6990834	099960	3	50	1/2 in	2 in	1-1/8 in	1-1/8 in	1-1/16 in	1-13/16 in	2-1/4 in	0.76 lb
9/16 in	6990934	099977	3	50	9/16 in	2-3/8 in	1-3/8 in	1-1/4 in	1-9/32 in	1-15/16 in	2-7/16 in	0.96 lb
5/8 in	6991034	099984	3	25	9/16 in	2-3/8 in	1-1/2 in	1-1/4 in	1-9/32 in	2-1/16 in	2-7/16 in	1.05 lb
3/4 in	6991234	099991	4	25	5/8 in	2-3/4 in	1-1/2 in	1-1/2 in	1-1/2 in	2-5/16 in	2-13/16 in	1.60 lb
7/8 in	6991434	100000	4	25	3/4 in	3-1/8 in	1-7/8 in	1-3/4 in	1-17/32 in	2-1/2 in	3-1/4 in	2.40 lb
1 in	6991634	100017	5	25	3/4 in	3-1/2 in	2-1/32 in	1-7/8 in	1-3/4 in	2-3/4 in	3-3/8 in	2.70 lb
1-1/8 in	6991834	100024	6	10	3/4 in	3-7/8 in	2-1/8 in	2-1/32 in	1-29/32 in	3 in	3-5/8 in	3.40 lb
1-1/4 in	6992034	100031	7	10	7/8 in	4-1/4 in	2-3/8 in	2-1/4 in	2-7/32 in	3-1/4 in	4 in	4.60 lb
1-1/2 in	6992434	100048	8	10	7/8 in	4-15/16 in	2-1/4 in	2-9/16 in	2-9/16 in	3-1/2 in	4-3/8 in	6.00 lb
1-3/4 in	6992835	100055	8	1	1-1/8 in	5-13/16 in	2-3/4 in	3-1/16 in	2-3/4 in	3-3/4 in	5-5/16 in	9.00 lb
2 in	6993235	100062	8	1	1-1/4 in	6-1/2 in	3 in	3-3/8 in	3-1/8 in	4-1/4 in	5-7/8 in	13.00 lb



## Wire Rope Bundling Clip

- For use with thimble eye wire rope choker slings
- Used in pre-slinging tubular loads
- Forged saddle marked with FORGED USA, Size, Date Code and Campbell logo
- Saddles, U-bolt with heavy hex nuts are galvanized to ASTM A-153
- U-bolt is colored blue for easy identification
- Meets requirements of ASME 30.26
- NOTE: Bundle clips nuts should be tightened with a torque wrench: tightening can be accomplished progressively by applying torque alternately to each nut in increments of ten percent of the torque value

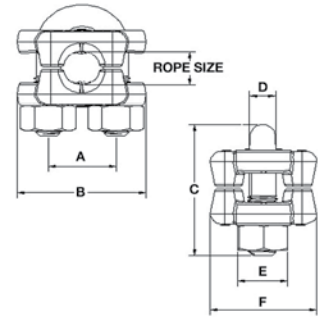

For Rope Diameter	Catalog No.	UPC No. 020418	Torque Value	Clips Per Box	A Dim.	B Dim.	C Dim.	D Dim.	E Dim.	F Dim.	Weight Each
3/4 in	T6991294	257780	130 ft/lb	20	1-1/2 in	2-13/16 in	3-5/16 in	5/8 in	1-1/16 in	2-5/16 in	2.20 lb

FITTINGS

## Stainless Steel Forged Wire Rope Clips, ST-43-V

- Base and U-Bolt Are Type 316 Stainless Steel
- Electro-Polish Finish
- Imported

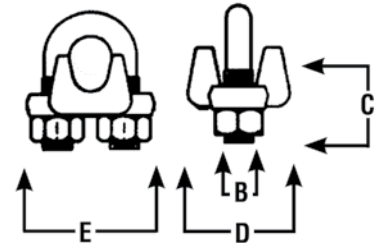

For Rope Diameter	Catalog No.	UPC No. 020418	Min. Clips Required	B Dim.	C Dim.	D Dim.	E Dim.	Weight Each
1/8 in	6403002	094101	2	5/32 in	9/16 in	3/4 in	3/4 in	0.04 lb
3/16 in	6403003	094118	2	1/4 in	3/4 in	7/8 in	1-1/8 in	0.10 lb
1/4 in	6403004	094125	2	5/16 in	1 in	1-1/8 in	1-3/8 in	0.18 lb
3/8 in	6403006	094132	2	1/2 in	1-3/8 in	1-1/2 in	2 in	0.52 lb
1/2 in	6403008	094149	3	9/16 in	2 in	1-7/8 in	2-5/16 in	0.89 lb

# Shackles

(1st letter indicates material, number is type, last letter indicates finish)

Round Pin Chain	C-416-S
Screw Pin Anchor	C-419-S, C-419-G, A-419-G
Screw Pin Chain	C-422-G
Bolt Type Anchor	C-999-G, A-999-G
Round Pin Anchor - Stainless	ST-997-V
Screw Pin Anchor - Stainless	ST-419-V
Bolt Type Anchor - Stainless	ST-999-V

**READ AND UNDERSTAND THESE WARNINGS AND INSTRUCTIONS BEFORE USING SHACKLES.**



**BOLT TYPE PIN  
ANCHOR  
SHACKLE**



**SCREW PIN  
ANCHOR  
SHACKLE**



**SCREW PIN  
CHAIN  
SHACKLE**



**CHAIN  
SHACKLE**

**FITTINGS**

## **WARNING**

- Failure to follow the instructions for use and these warnings may cause death or serious injury.
- Use shackles only as indicated.
- Shackles must always be inspected for wear, distortion and damage before use. If the pin or bow is worn, distorted or damaged, discard the entire shackle and replace.
- Do not use round pin shackles in rigging applications.
- Screw pin shackles should not be used if there will be movement on the pin. Movement could cause the pin to unscrew and drop the load.
- Screw pin should be tightened prior to use.
- Always stand clear of loads being lifted.



## Shackles (continued)

Campbell carbon and alloy steel shackles are drop-forged. All pins and bolts are galvanized and made of alloy steel. The shackles meet the design requirements of Federal Specification RR-C-271, Type IV. Galvanizing meets ASTM A-153 specification. Self-colored shackles are painted blue for identification purposes.

Campbell stainless steel shackles are drop-forged and made of Type 316 Stainless Steel with an electro-polished finish.

### IMPORTANT: Instructions For Use

1. Do not exceed working load limit (WLL). See tables below.
2. The standard WLL given applies to in-line loading (perpendicular to the pin). When the loading is at an angle, the WLL is reduced as shown in the table below.
3. Any angular loads must be on the bow. All straight loading should be on the pin.

### WLL in Tons Campbell Carbon & Alloy Shackles

Shackle Size		In-Line Load WLL		45° Load WLL 30% Loss		90° Load WLL 50% Loss	
Inches	mm	Ton*	kg	Ton*	kg	Ton*	kg
3/16"	5	1/3	302	1/5	181	1/6	151
1/4"	6	1/2	454	1/3	302	1/4	227
5/16"	8	3/4	680	1/2	454	1/3	302
3/8"	10	1	907	2/3	605	1/2	454
3/8" Alloy*	10	2	2000	1-1/3	1400	1	1000
7/16"	11	1-1/2	1361	1	907	3/4	680
1/2"	13	2	1814	1-1/3	1210	1	907
1/2" Alloy*	13	3-1/4	3250	2-1/3	2333	1-1/2	1500
5/8"	16	3-1/4	2948	2-1/4	2041	1-1/2	1361
5/8" Alloy*	16	5	5000	3-1/2	3500	2-1/2	2500
3/4"	19	4-3/4	4309	3-1/3	3024	2-1/3	2117
3/4" Alloy*	19	7	7000	5	5000	3-1/2	3500
7/8"	22	6-1/2	5897	4-1/2	4082	3-1/4	2948
7/8" Alloy*	22	9-1/2	9500	6 2/3	6667	4-3/4	4750
1"	25	8-1/2	7711	6	5443	4-1/4	3856
1" Alloy*	25	12-1/2	12500	8-3/4	8750	6-1/4	6250
1-1/8"	29	9-1/2	8618	6-2/3	6048	4-3/4	4309
1-1/4"	32	12	10886	8-1/3	7560	6	5443
1-1/4" Alloy*	32	18	18000	12-1/2	12500	9	9000
1-3/8"	35	13-1/2	12247	9-1/2	8618	6-3/4	6123
1-3/8" Alloy*	35	21	21000	14-3/4	14750	10-1/2	10500
1-1/2"	38	17	15422	11-7/8	10773	8-1/2	7711
1-1/2" Alloy*	38	30	30000	21	21000	15	15000
1-3/4"	44	25	22680	17-1/2	15876	12-1/2	11340
1-3/4" Alloy*	44	40	40000	28	28000	20	20000
2"	51	35	31751	24-1/2	22226	17-1/2	15876
2" Alloy*	51	55	55000	38-1/2	38500	27-1/2	27500
2-1/2"	64	55	49895	38-1/2	34926	27-1/2	24947
2-1/2" Alloy*	64	85	85000	59-1/2	59500	42-1/2	42500

### WLL in Lbs. Campbell Stainless Shackles

Shackle Size		In-Line Load WLL		45° Load WLL 30% Loss		90° Load WLL 50% Loss	
Inches	mm	Lbs*	kg	Lbs*	kg	Lbs*	kg
1/4"	6	1000	454	700	318	500	227
3/8"	10	2000	907	1400	635	1000	454
7/16"	11	3000	1362	2100	953	1500	681
1/2"	13	4000	1814	2800	1270	2000	907
5/8"	16	6000	2722	4200	1905	3000	1362
3/4"	19	8000	3629	5600	2540	4000	1814

\*Alloy Shackles are rated in Metric Tons



## Carbon Bolt Type Anchor Shackles, Galvanized, C-999-G

- Shackle Bodies Are Drop-Forged Carbon Steel
- Galvanized to Meet ASTM A-153 Specifications
- C-999-G Shackles Meet the Design Requirements of Federal Specification RR-C-271, Type IVA, Grade A, Class 3
- Working Load Limit, Size, Manufacture Name, Date Code and USA Permanently Marked on Each Shackle
- Statistically Tested for Impact Resistance, Tensile Strength, Hardness, Ductility and Fatigue
- 999 Series Shackles Meet or Exceed All Manufacturing Requirements of the ASME B30.26 "Rigging Hardware". These Include the Material Ductility Requirement (Section 26-1.1.2), the Design Factor Requirement (Section 26.1.2), the Identification Requirement (Section 26-1.5.1), and the Effective Temperature Range (Section 26-1.6.1). the Shackles Can Be Proof Tested in Accordance with Section 26-1.4
- Certification Available Upon Request
- 6 to 1 Design Factor
- Pins and Bolts Are Heat-Treated and Made of Alloy Steel
- DO NOT EXCEED THE WORKING LOAD LIMIT

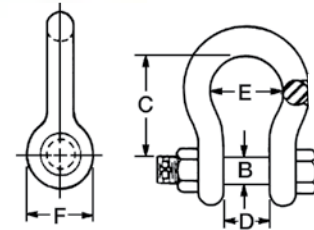

Trade Size	Catalog No.	UPC No. 020148	Working Load Limit (Short Tons)	B Dim.	C Dim.	D Dim.	E Dim.	F Dim.	(C) Tolerance (+/-)	(D) Tolerance (+/-)	Weight Each
1/4 in	5390435	193156	1/2 T	5/16 in	1-1/8 in	15/32 in	25/32 in	11/16 in	1/16 in	1/8 in	0.10 lb
3/8 in	5390635	193170	1 T	7/16 in	1-7/16 in	21/32 in	31/32 in	15/16 in	1/8 in	1/8 in	0.30 lb
1/2 in	5390835	075520	2 T	5/8 in	1-15/16 in	13/16 in	1-1/4 in	1-1/4 in	1/8 in	1/8 in	0.70 lb
5/8 in	5391035	075544	3-1/4 T	3/4 in	2-7/16 in	1-1/16 in	1-9/16 in	1-7/16 in	1/8 in	1/8 in	1.30 lb
3/4 in	5391235	075568	4-3/4 T	7/8 in	2-13/16 in	1-1/4 in	1-13/16 in	1-3/4 in	1/4 in	1/8 in	2.00 lb
7/8 in	5391435	075582	6-1/2 T	1 in	3-1/8 in	1-7/16 in	2-1/16 in	2 in	1/4 in	1/8 in	3.30 lb
1 in	5391635	075605	8-1/2 T	1-1/8 in	3-3/4 in	1-11/16 in	2-1/2 in	2-3/8 in	1/4 in	1/8 in	5.00 lb
1-1/8 in	5391835	075629	9-1/2 T	1-1/4 in	4-1/4 in	1-13/16 in	2-15/16 in	2-5/8 in	1/4 in	1/8 in	7.10 lb
1-1/4 in	5392035	075643	12 T	1-3/8 in	4-1/2 in	2 in	3-1/4 in	3 in	1/4 in	1/8 in	10.00 lb
1-3/8 in	5392235	075667	13-1/2 T	1-1/2 in	5-1/4 in	2-1/4 in	3-1/2 in	3-1/4 in	1/4 in	3/16 in	13.00 lb
1-1/2 in	5392435	075681	17 T	1-5/8 in	5-3/4 in	2-3/8 in	3-7/8 in	3-1/2 in	1/4 in	3/16 in	16.00 lb
1-3/4 in	5392835	075735	25 T	2 in	7 in	2-7/8 in	4-3/4 in	4 in	1/4 in	3/16 in	28.50 lb
2 in	5393235	075766	35 T	2-1/4 in	7-3/4 in	3-1/4 in	5-3/4 in	4-7/8 in	1/2 in	3/16 in	40.00 lb
2-1/2 in	5394035	075797	55 T	2-3/4 in	10-9/16 in	4-1/8 in	7-1/4 in	5-1/2 in	1/2 in	1/4 in	90.00 lb

FITTINGS





## Alloy Bolt Type Anchor Shackles, Galvanized, A-999-G

- Shackle Bodies Are Drop-Forged Alloy Steel
- Galvanized to Meet ASTM A-153 Specifications
- A-999-G Shackles Meet the Design Requirements of Federal Specification RR-C-271, Type IVA Grade B, Class 3
- Working Load Limit, Size, Manufacture Name, Date Code, "CE" Mark, and USA Permanently Marked on Each Shackle
- Statistically Tested for Impact Resistance, Tensile Strength, Hardness, Ductility and Fatigue
- 999 Series Shackles Meet or Exceed All Manufacturing Requirements of the ASME B30.26 "Rigging Hardware". These Include the Material Ductility Requirement (Section 26-1.1.2), the Design Factor Requirement (Section 26.1.2), the Identification Requirement (Section 26-1.5.1), and the Effective Temperature Range (Section 26-1.6.1). the Shackles Can Be Proof Tested in Accordance with Section 26-1.4
- Certification Available Upon Request
- 5 to 1 Design Factor
- Pins and Bolts Are Heat-Treated, Made of Alloy Steel and Painted Orange
- DO NOT EXCEED THE WORKING LOAD LIMIT

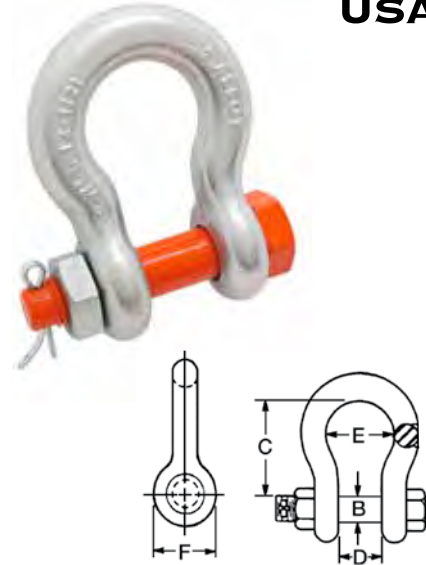

FITTINGS

Trade Size	Catalog No.	UPC No. 020418	Working Load Limit (Metric Tons)	B Dim.	C Dim.	D Dim.	E Dim.	F Dim.	(C) Tolerance (+/-)	(D) Tolerance (+/-)	Weight Each
3/8 in	5390695	267338	2 t	7/16 in	1-7/16 in	21/32 in	31/32 in	15/16 in	1/8 in	1/8 in	0.30 lb
1/2 in	5390895	182198	3-1/3 t	5/8 in	1-15/16 in	13/16 in	1-1/4 in	1-1/4 in	1/8 in	1/8 in	0.88 lb
5/8 in	5391095	267345	5 t	3/4 in	2-3/8 in	1-1/16 in	1-11/16 in	1-1/2 in	1/8 in	1/8 in	1.40 lb
3/4 in	5391295	182105	7 t	7/8 in	2-13/16 in	1-1/4 in	1-13/16 in	1-3/4 in	1/4 in	1/8 in	2.66 lb
7/8 in	5391495	267352	9-1/2 t	1 in	3-5/16 in	1-7/16 in	2-9/32 in	2-3/32 in	1/4 in	1/8 in	3.60 lb
1 in	5391695	182112	12-1/2 t	1-1/8 in	3-3/4 in	1-11/16 in	2-1/2 in	2-3/8 in	1/4 in	1/8 in	6.12 lb
1-1/4 in	5392095	267369	18 t	1-3/8 in	4-1/2 in	2 in	3-1/4 in	3 in	1/4 in	1/8 in	10.00 lb
1-3/8 in	5392295	267376	21 t	1-1/2 in	5-1/4 in	2-1/4 in	3-5/8 in	3-5/16 in	1/4 in	3/16 in	13.30 lb
1-1/2 in	5392495	267383	30 t	1-5/8 in	5-3/4 in	2-3/8 in	3-7/8 in	3-5/8 in	1/4 in	3/16 in	18.90 lb
1-3/4 in	5392895	267390	40 t	2 in	7 in	2-7/8 in	4-7/8 in	4-3/16 in	1/4 in	3/16 in	33.90 lb
2 in	5393295	267406	55 t	2-1/4 in	7-3/4 in	3-1/4 in	5-3/4 in	4-7/8 in	1/2 in	3/16 in	50.00 lb
2-1/2 in	5394095	267413	85 t	2-3/4 in	10-1/2 in	4-1/8 in	7-1/4 in	5-13/16 in	1/2 in	1/4 in	100.30 lb

## Stainless Steel Bolt Type Anchor Shackles, ST-999-V

- Forged Type 316 Stainless Steel
- Electro-Polish Finish
- Imported
- DO NOT EXCEED THE WORKING LOAD LIMIT

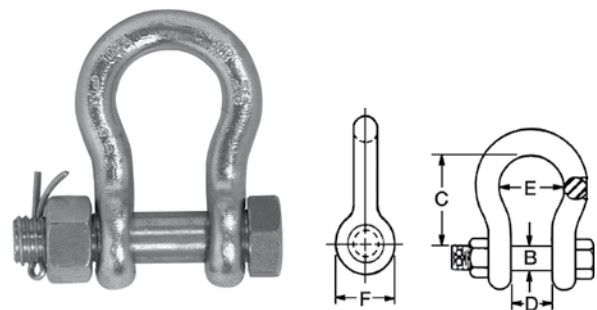

Trade Size	Catalog No.	UPC No. 020418	Working Load Limit (Short Tons)	B Dim.	C Dim.	D Dim.	E Dim.	F Dim.	(C) Tolerance (+/-)	(D) Tolerance (+/-)	Weight Each
3/8 in	6402406	093869	3/4 T	7/16 in	1-7/16 in	21/32 in	31/32 in	15/16 in	1/8 in	1/8 in	0.31 lb
1/2 in	6402408	093883	1-1/2 T	5/8 in	1-15/16 in	13/16 in	1-1/4 in	1-1/4 in	1/8 in	1/8 in	0.72 lb
5/8 in	6402410	093890	2 T	3/4 in	2-7/16 in	1-1/16 in	1-9/16 in	1-7/16 in	1/8 in	1/8 in	1.38 lb



## Carbon Screw Pin Anchor Shackles, Self-Colored, C-419-S

- Shackle Bodies Are Drop-Forged Carbon Steel
- Self Colored (Painted Blue)
- C-419-S Shackles Meet the Design Requirements of Federal Specification RR-C-271, Type IVA, Grade A, Class 2
- Working Load Limit, Size, Manufacture Name, Date Code and USA Permanently Marked on Each Shackle
- Statistically Tested for Impact Resistance, Tensile Strength, Hardness, Ductility and Fatigue
- 419 Series Shackles Meet or Exceed All Manufacturing Requirements of the ASME B30.26 "Rigging Hardware". These Include the Material Ductility Requirement (Section 26-1.1.2), the Design Factor Requirement (Section 26.1.2), the Identification Requirement (Section 26-1.5.1), and the Effective Temperature Range (Section 26-1.6.1). the Shackles Can Be Proof Tested in Accordance with Section 26-1.4
- Certification Available Upon Request
- 6 to 1 Design Factor
- Pins and Bolts Are Heat-Treated and Made of Alloy Steel
- DO NOT EXCEED THE WORKING LOAD LIMIT

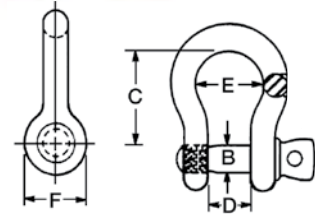

Trade Size	Catalog No.	UPC No. 020418	Working Load Limit (Short Tons)	B Dim.	C Dim.	D Dim.	E Dim.	F Dim.	(C) Tolerance (+/-)	(D) Tolerance (+/-)	Weight Each
1/4 in	5410405	076145	1/2 T	5/16 in	1-1/8 in	15/32 in	25/32 in	11/16 in	1/16 in	1/8 in	0.10 lb
5/16 in	5410505	076176	3/4 T	3/8 in	1-1/4 in	17/32 in	27/32 in	3/4 in	1/16 in	1/8 in	0.20 lb
3/8 in	5410605	076206	1 T	7/16 in	1-7/16 in	21/32 in	31/32 in	15/16 in	1/8 in	1/8 in	0.30 lb
7/16 in	5410705	076237	1-1/2 T	1/2 in	1-3/4 in	23/32 in	1-5/32 in	1-1/8 in	1/8 in	1/8 in	0.52 lb
1/2 in	5410805	076268	2 T	5/8 in	1-15/16 in	13/16 in	1-1/4 in	1-1/4 in	1/8 in	1/8 in	0.80 lb
5/8 in	5411005	076282	3-1/4 T	3/4 in	2-7/16 in	1-1/16 in	1-9/16 in	1-7/16 in	1/8 in	1/8 in	1.50 lb
3/4 in	5411205	076305	4-3/4 T	7/8 in	2-13/16 in	1-1/4 in	1-13/16 in	1-3/4 in	1/4 in	1/8 in	2.00 lb
7/8 in	5411405	076329	6-1/2 T	1 in	3-1/8 in	1-7/16 in	2-1/16 in	2 in	1/4 in	1/8 in	3.20 lb
1 in	5411605	076343	8-1/2 T	1-1/8 in	3-3/4 in	1-11/16 in	2-1/2 in	2-3/8 in	1/4 in	1/8 in	5.00 lb
1-1/8 in	5411805	076367	9-1/2 T	1-1/4 in	4-1/4 in	1-13/16 in	2-15/16 in	2-5/8 in	1/4 in	1/8 in	7.00 lb
1-1/4 in	5412005	076381	12 T	1-3/8 in	4-1/2 in	2 in	3-1/4 in	3 in	1/4 in	1/8 in	10.00 lb
1-3/8 in	5412205	076404	13-1/2 T	1-1/2 in	5-1/4 in	2-1/4 in	3-1/2 in	3-1/4 in	1/4 in	3/16 in	13.00 lb
1-1/2 in	5412405	076428	17 T	1-5/8 in	5-3/4 in	2-3/8 in	3-7/8 in	3-1/2 in	1/4 in	3/16 in	16.00 lb
1-3/4 in	5412805	076459	25 T	2 in	7 in	2-7/8 in	4-3/4 in	4 in	1/4 in	3/16 in	26.00 lb
2 in	5413205	076473	35 T	2-1/4 in	7-3/4 in	3-1/4 in	5-3/4 in	4-7/8 in	1/2 in	3/16 in	41.00 lb

FITTINGS



## Carbon Screw Pin Anchor Shackles, Galvanized, C-419-G

- Shackle Bodies Are Drop-Forged Carbon Steel
- Galvanized to Meet ASTM A-153 Specifications
- C-419-G Shackles Meet the Design Requirements of Federal Specification RR-C-271, Type IVA, Grade A, Class 2
- Working Load Limit, Size, Manufacture Name, Date Code and USA Permanently Marked on Each Shackle
- Statistically Tested for Impact Resistance, Tensile Strength, Hardness, Ductility and Fatigue
- 419 Series Shackles Meet or Exceed All Manufacturing Requirements of the ASME B30.26 "Rigging Hardware". These Include the Material Ductility Requirement (Section 26-1.1.2), the Design Factor Requirement (Section 26.1.2), the Identification Requirement (Section 26-1.5.1), and the Effective Temperature Range (Section 26-1.6.1). the Shackles Can Be Proof Tested in Accordance with Section 26-1.4
- Certification Available Upon Request
- 6 to 1 Design Factor
- Pins and Bolts Are Heat-Treated and Made of Alloy Steel
- DO NOT EXCEED THE WORKING LOAD LIMIT

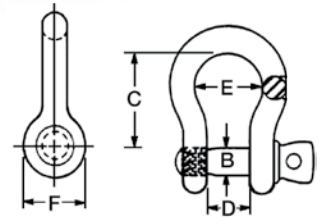

FITTINGS

Trade Size	Catalog No.	UPC No. 020418	Working Load Limit (Short Tons)	B Dim.	C Dim.	D Dim.	E Dim.	F Dim.	(C) Tolerance (+/-)	(D) Tolerance (+/-)	Weight Each
3/16 in	5410335	076138	1/3 T	1/4 in	7/8 in	3/8 in	19/32 in	9/16 in	1/16 in	1/8 in	0.05 lb
1/4 in	5410435	076169	1/2 T	5/16 in	1-1/8 in	15/32 in	25/32 in	11/16 in	1/16 in	1/8 in	0.10 lb
5/16 in	5410535	076190	3/4 T	3/8 in	1-1/4 in	17/32 in	27/32 in	3/4 in	1/16 in	1/8 in	0.20 lb
3/8 in	5410635	076220	1 T	7/16 in	1-7/16 in	21/32 in	31/32 in	15/16 in	1/8 in	1/8 in	0.30 lb
7/16 in	5410735	076251	1-1/2 T	1/2 in	1-3/4 in	23/32 in	1-5/32 in	1-1/8 in	1/8 in	1/8 in	0.52 lb
1/2 in	5410835	076275	2 T	5/8 in	1-15/16 in	13/16 in	1-1/4 in	1-1/4 in	1/8 in	1/8 in	0.80 lb
5/8 in	5411035	076299	3-1/4 T	3/4 in	2-7/16 in	1-1/16 in	1-9/16 in	1-7/16 in	1/8 in	1/8 in	1.06 lb
3/4 in	5411235	076312	4-3/4 T	7/8 in	2-13/16 in	1-1/4 in	1-13/16 in	1-3/4 in	1/4 in	1/8 in	2.15 lb
7/8 in	5411435	076336	6-1/2 T	1 in	3-1/8 in	1-7/16 in	2-1/16 in	2 in	1/4 in	1/8 in	3.20 lb
1 in	5411635	076350	8-1/2 T	1-1/8 in	3-3/4 in	1-11/16 in	2-1/2 in	2-3/8 in	1/4 in	1/8 in	5.00 lb
1-1/8 in	5411835	076374	9-1/2 T	1-1/4 in	4-1/4 in	1-13/16 in	2-15/16 in	2-5/8 in	1/4 in	1/8 in	7.00 lb
1-1/4 in	5412035	076398	12 T	1-3/8 in	4-1/2 in	2 in	3-1/4 in	3 in	1/4 in	1/8 in	10.00 lb
1-3/8 in	5412235	076411	13-1/2 T	1-1/2 in	5-1/4 in	2-1/4 in	3-1/2 in	3-1/4 in	1/4 in	3/16 in	13.00 lb
1-1/2 in	5412435	076435	17 T	1-5/8 in	5-3/4 in	2-3/8 in	3-7/8 in	3-1/2 in	1/4 in	3/16 in	16.00 lb
1-3/4 in	5412835	076466	25 T	2 in	7 in	2-7/8 in	4-3/4 in	4 in	1/4 in	3/16 in	26.00 lb
2 in	5413235	076480	35 T	2-1/4 in	7-3/4 in	3-1/4 in	5-3/4 in	4-7/8 in	1/2 in	3/16 in	40.00 lb
2-1/2 in	5414035	076527	55 T	2-3/4 in	10-9/16 in	4-1/8 in	7-1/4 in	5-1/2 in	1/2 in	1/4 in	90.00 lb



## Alloy Screw Pin Anchor Shackles, Galvanized, A-419-G

- Shackle Bodies Are Drop-Forged Alloy Steel
- Galvanized to Meet ASTM A-153 Specifications
- A-419-G Shackles Meet the Design Requirements of Federal Specification RR-C-271, Type IVA, Grade B, Class 2
- Working Load Limit, Size, Manufacture Name, Date Code, "CE" Mark, and USA Permanently Marked on Each Shackle
- Statistically Tested for Impact Resistance, Tensile Strength, Hardness, Ductility and Fatigue
- 419 Series Shackles Meet or Exceed All Manufacturing Requirements of the ASME B30.26 "Rigging Hardware". These Include the Material Ductility Requirement (Section 26-1.1.2), the Design Factor Requirement (Section 26.1.2), the Identification Requirement (Section 26-1.5.1), and the Effective Temperature Range (Section 26-1.6.1). the Shackles Can Be Proof Tested in Accordance with Section 26-1.4
- Certification Available Upon Request
- 5 to 1 Design Factor
- Pins and Bolts Are Heat-Treated and Made of Alloy Steel and Painted Orange
- DO NOT EXCEED THE WORKING LOAD LIMIT

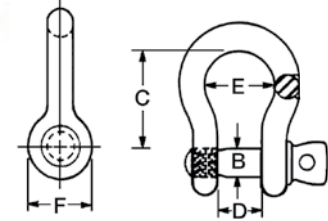

Trade Size	Catalog No.	UPC No. 020418	Working Load Limit (Metric Tons)	B Dim.	C Dim.	D Dim.	E Dim.	F Dim.	(C) Tolerance (+/-)	(D) Tolerance (+/-)	Weight Each
3/8 in	5410695	182136	2 t	7/16 in	1-7/16 in	21/32 in	31/32 in	15/16 in	1/8 in	1/8 in	0.31 lb
1/2 in	5410895	182143	3-1/3 t	5/8 in	1-15/16 in	13/16 in	1-1/4 in	1-1/4 in	1/8 in	1/8 in	0.70 lb
5/8 in	5411095	267420	5 t	3/4 in	2-3/8 in	1-1/16 in	1-11/16 in	1-1/2 in	1/8 in	1/8 in	1.40 lb
3/4 in	5411295	182150	7 t	7/8 in	2-13/16 in	1-1/4 in	1-13/16 in	1-3/4 in	1/4 in	1/8 in	2.00 lb
7/8 in	5411495	267437	9-1/2 t	1 in	3-5/16 in	1-7/16 in	2-9/32 in	2-3/32 in	1/4 in	1/8 in	3.60 lb
1 in	5411695	182167	12-1/2 t	1-1/8 in	3-3/4 in	1-11/16 in	2-1/2 in	2-3/8 in	1/4 in	1/8 in	5.70 lb
1-1/4 in	5412095	182174	18 t	1-3/8 in	4-1/2 in	2 in	3-1/4 in	3 in	1/4 in	1/8 in	10.50 lb
1-3/8 in	5412295	267444	21 t	1-1/2 in	5-1/4 in	2-1/4 in	3-5/8 in	3-5/16 in	1/4 in	3/16 in	13.30 lb
1-1/2 in	5412495	267451	30 t	1-5/8 in	5-3/4 in	2-3/8 in	3-7/8 in	3-5/8 in	1/4 in	3/16 in	18.90 lb
2 in	5413295	267468	55 t	2-1/4 in	7-3/4 in	3-1/4 in	5-3/4 in	4-7/8 in	1/2 in	3/16 in	50.00 lb

## Stainless Steel Screw Pin Anchor Shackles (Import)

- Forged Type 316 Stainless Steel
- Electro-Polish Finish
- Imported
- DO NOT EXCEED THE WORKING LOAD LIMIT

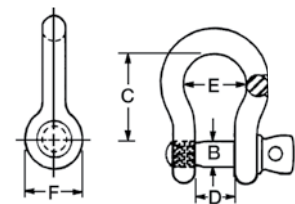

Trade Size	Catalog No.	UPC No. 020418	Working Load Limit (Short Tons)	B Dim.	C Dim.	D Dim.	E Dim.	F Dim.	(C) Tolerance (+/-)	(D) Tolerance (+/-)	Weight Each
1/4 in	6402104	093654	1/2 T	5/16 in	1-1/8 in	1/2 in	3/4 in	11/16 in	1/16 in	1/8 in	0.12 lb
3/8 in	6402106	093678	3/4 T	7/16 in	1-7/16 in	21/32 in	31/32 in	15/16 in	1/8 in	1/8 in	0.31 lb
7/16 in	6402107	093685	1 T	1/2 in	1-3/4 in	23/32 in	1-5/32 in	1-1/8 in	1/8 in	1/8 in	0.50 lb
1/2 in	6402108	093692	1-1/2 T	5/8 in	1-15/16 in	13/16 in	1-1/4 in	1-1/4 in	1/8 in	1/8 in	0.72 lb
5/8 in	6402110	093708	2 T	3/4 in	2-7/16 in	1-1/16 in	1-9/16 in	1-7/16 in	1/8 in	1/8 in	1.38 lb
3/4 in	6402112	093715	3 T	7/8 in	2-13/16 in	1-1/4 in	1-13/16 in	1-3/4 in	1/4 in	1/8 in	2.22 lb

FITTINGS



## Carbon Round Pin Chain Shackles, Self-Colored, C-416-S

- Shackle Bodies Are Drop-Forged Carbon Steel
- Self Colored (Painted Blue)
- C-416-S Shackles Meet the Design Requirements of Federal Specification RR-C-271, Type IVB, Grade A, Class 1
- Working Load Limit, Size, Manufacture Name, Date Code and USA Permanently Marked on Each Shackle Meeting or Exceeding Requirements of ASME 30.26
- Statistically Tested for Impact Resistance, Tensile Strength, Hardness, Ductility and Fatigue
- Certification Available Upon Request
- 6 to 1 Design Factor
- Pins and Bolts Are Heat-Treated and Made of Alloy Steel
- Made in the USA

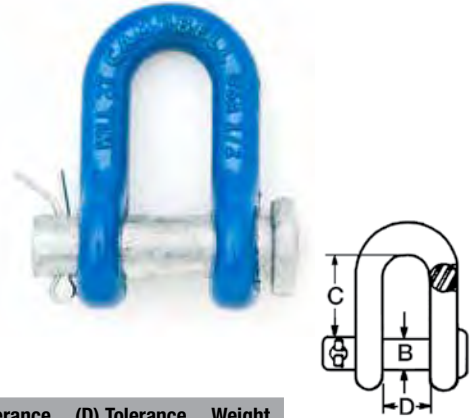

Trade Size	Catalog No.	UPC No. 020418	Working Load Limit (Short Tons)	B Dim.	C Dim.	D Dim.	(C) Tolerance (+/-)	(D) Tolerance (+/-)	Weight Each
5/16 in	5420505	076558	3/4 T	3/8 in	1 in	17/32 in	1/16 in	1/8 in	0.17 lb
3/8 in	5420605	076572	1 T	7/16 in	1-1/4 in	21/32 in	1/8 in	1/8 in	0.29 lb
7/16 in	5420705	076596	1-1/2 T	1/2 in	1-1/2 in	23/32 in	1/8 in	1/8 in	0.40 lb
1/2 in	5420805	076619	2 T	5/8 in	1-11/16 in	13/16 in	1/8 in	1/8 in	0.60 lb

FITTINGS

## Carbon Screw Pin Chain Shackles, Galvanized, C-422-G



- Shackle Bodies Are Drop-Forged Carbon Steel
- Galvanized to Meet ASTM A-153 Specifications
- C-422-G Shackles Meet the Design Requirements of Federal Specification RR-C-271, Type IVB, Grade A, Class 2
- Working Load Limit, Size, Manufacture Name, Date Code and USA Permanently Marked on Each Shackle
- Statistically Tested for Impact Resistance, Tensile Strength, Hardness, Ductility and Fatigue
- 422 Series Shackles Meet or Exceed All Manufacturing Requirements of the American Society for Mechanical Engineers (Asme) B30.26 "Rigging Hardware". These Include the Material Ductility Requirement (Section 26-1.1.2), the Design Factor Requirement (Section 26-1.2), the Identification Requirement (Section 26-1.5.1) and the Effective Temperature Range (Section 26-1.6.1) the Shackles Can Be Proof Tested in Accordance with Section 26-1.4
- Certification Available Upon Request
- 6 to 1 Design Factor
- Pins and Bolts Are Heat-Treated and Made of Alloy Steel
- Made in the USA



Trade Size	Catalog No.	UPC No. 020418	Working Load Limit (Short Tons)	B Dim.	C Dim.	D Dim.	(C) Tolerance (+/-)	(D) Tolerance (+/-)	Weight Each
5/16 in	5430535	076923	3/4 T	3/8 in	1 in	17/32 in	1/16 in	1/8 in	0.17 lb
3/8 in	5430635	076947	1 T	7/16 in	1-1/4 in	21/32 in	1/8 in	1/8 in	0.30 lb
1/2 in	5430835	076985	2 T	5/8 in	1-11/16 in	13/16 in	1/8 in	1/8 in	0.75 lb
5/8 in	5431035	077005	3-1/4 T	3/4 in	2 in	1-1/16 in	1/8 in	1/8 in	1.25 lb
1 in	5431635	077067	8-1/2 T	1-1/8 in	3-1/4 in	1-11/16 in	1/4 in	1/8 in	4.50 lb

## Hoist Hooks

Campbell hoist hooks are all drop-forged and heat treated. All hooks are drilled for latch assembly.

(1st letter indicates material, number is type, last letter indicates finish)

Eye Hoist - Unlatched	C-1010-S, A-1010-0
Eye Hoist - Latched	C-1015-S, C-1015-G, A-1015-0
Swivel Hoist - Unlatched	C-1013-S, A-1013-0
Swivel Hoist - Latched	C-1014-S, A-1014-0



SWIVEL HOIST HOOK



EYE HOIST HOOK

**READ AND UNDERSTAND THESE WARNINGS AND INSTRUCTIONS BEFORE USING HOIST HOOKS.**

### IMPORTANT: Instructions For Use

1. For hooks with latches, the latch is only designed to retain slings and rigging attachments. The latch must not support the load.
2. Swivel hoist hooks are not designed to swivel under load.
3. Do not exceed working load limit (WLL). See table right.

### Working Load Limits — Swivels

Size	Carbon Steel WLL		Alloy WLL	
	Ton	kg	Ton	kg
2/22	¾	680	1	907
3/23	1	907	1½	1361
4/24	1½	1361	2	1814
5/25	2	1814	3	2722
6/26	2½	2268	4	3629
7/27	3	2722	5	4082
9/29	5	4536	7	6350
11/31	7½	6804	11	9979
12/32	10	9072	15	13608
34	-	-	22	19958

### WARNING

- Failure to follow the instructions for use and these warnings may cause death or serious injury.
- Use hoist hooks only as indicated.
- Never point load a hook.
- Do not use hooks for lifting personnel.
- Hooks must always be inspected for wear, distortion and damage before use. If worn, distorted or damaged, discard and replace.
- Do not weld on hooks. If a hook is exposed to weld spatter, discard that hook.
- Always stand clear of loads being lifted.



## Swivel Hoist Hooks, C-1013-S, A-1013-0

- Drop Forged Carbon Steel or Alloy and Heat Treated
- Carbon Steel Hooks Are Painted Blue; Alloy Hooks Are Painted Orange
- Design Factor: 5 to 1
- All Hooks Are Drilled for Integrated Latch Kits
- The Latch Is Only Designed to Retain Slings and Rigging Attachments. The Latch Must Not Support the Load.
- Swivel Hoist Hooks ARE NOT Designed to Swivel Under Load.
- DO NOT EXCEED THE WORKING LOAD LIMIT



Trade Size	Catalog No.	UPC No. 020418	Material	Finish	Working Load Limit (Short Tons)	Latch Marking	Replacement Latch No.
4	3950415IL	239236	Alloy Steel	Painted Orange	2 T	CC-4	7506495
5	3950515IL	237966	Alloy Steel	Painted Orange	3 T	CC-4	7506495
7	3940705IL	240508	Carbon Steel	Painted Blue	3 T	CC-5	7506695
7	3950715IL	240492	Alloy Steel	Painted Orange	4-1/2 T	CC-5	7506695
9	3940905IL	240539	Carbon Steel	Painted Blue	5 T	CC-7	7506895
11	3941105IL	240416	Carbon Steel	Painted Blue	7-1/2 T	CC-8	7507095
11	3941105PL	295607	Carbon Steel	Painted Blue	7-1/2 T	PL-8	7507095PL
11	3951115PL	295645	Alloy Steel	Painted Orange	11 T	PL-8	7507095PL
12	3951215IL	240515	Alloy Steel	Painted Orange	15 T	CC-9	7507295
12	3951215PL	295621	Alloy Steel	Painted Orange	15 T	PL-9	7507295PL
14	3951415PL	295638	Alloy Steel	Painted Orange	22 T	PL-10	7507495PL

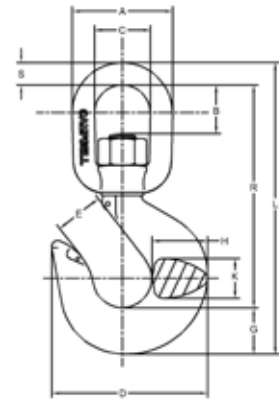

Trade Size	Catalog No.	A Dim.	B Dim.	C Dim.	D Dim.	E Dim.	G Dim.	H Dim.	K Dim.	L Dim.	R Dim.	S Dim.
4	3950415IL	2-1/2 in	1-1/4 in	1-1/2 in	3-9/16 in	1-1/8 in	1-1/32 in	1-1/8 in	11/16 in	7-5/16 in	5-13/16 in	1/2 in
5	3950515IL	3 in	1-5/8 in	1-3/4 in	4 in	1-1/4 in	1-5/32 in	1-5/16 in	13/16 in	8-3/16 in	6-7/16 in	5/8 in
7	3940705IL	3-1/2 in	1-3/4 in	2 in	4-15/16 in	1-17/32 in	1-7/16 in	1-5/8 in	1-1/16 in	9-7/16 in	8 in	3/4 in
7	3950715IL	3-1/2 in	1-3/4 in	2 in	4-15/16 in	1-17/32 in	1-7/16 in	1-5/8 in	1-1/16 in	9-7/16 in	8 in	3/4 in
9	3940905IL	4-1/2 in	2-1/4 in	2-1/2 in	6-15/32 in	1-31/32 in	1-13/16 in	2-1/8 in	1-3/8 in	12-3/8 in	9-5/8 in	1 in
11	3941105IL	5-5/8 in	2-27/32 in	3-1/8 in	7-11/32 in	2-1/8 in	2-1/4 in	2-5/8 in	1-1/2 in	15 in	11-9/16 in	1-1/4 in
11	3941105PL	5-5/8 in	3-1/8 in	3-1/8 in	7-9/16 in	2-17/32 in	2-9/32 in	2-23/32 in	2 in	15-7/8 in	12-11/32 in	1-1/4 in
11	3951115IL	5-5/8 in	2-27/32 in	3-1/8 in	7-11/32 in	2-1/8 in	2-1/4 in	2-5/8 in	1-1/2 in	15 in	11-9/16 in	1-1/4 in
11	3951115PL	5-5/8 in	3-1/8 in	3-1/8 in	7-9/16 in	2-17/32 in	2-9/32 in	2-23/32 in	2 in	15-7/8 in	12-11/32 in	1-1/4 in
12	3951215IL	5-5/8 in	2-3/4 in	3-1/8 in	7-13/16 in	2-9/16 in	2-9/16 in	2-15/16 in	1-13/16 in	16-1/32 in	12-1/4 in	1-1/4 in
12	3951215PL	5-5/8 in	2-3/4 in	3-1/8 in	8-3/4 in	2-3/4 in	2-19/32 in	3-1/8 in	2-1/4 in	16-13/32 in	12-17/32 in	1-1/4 in
14	3951415PL	7-1/2 in	3-25/32 in	4-1/4 in	11-3/8 in	3-5/8 in	3-1/8 in	3-15/16 in	2-23/32 in	21-9/16 in	16-25/32 in	1-5/8 in

## Swivel Hoist Hooks - Latched, C-1014-S, A-1014-0

- Drop Forged Carbon Steel or Alloy and Heat Treated
- Carbon Steel Hooks Are Painted Blue; Alloy Hooks Are Painted Orange
- Design Factor: 5 to 1
- All Hooks Are Drilled for Integrated Latch Kits
- The Latch Is Only Designed to Retain Slings and Rigging Attachments. The Latch Must Not Support the Load.
- Swivel Hoist Hooks ARE NOT Designed to Swivel Under Load.
- DO NOT EXCEED THE WORKING LOAD LIMIT



Trade Size	Catalog No.	UPC No. 020418	Material	Finish	Working Load Limit (Short Tons)	Latch Marking	Replacement Latch No.
2	3942205IL	236242	Carbon Steel	Painted Blue	3/4 T	CC-3	T7502101
2	3952215IL	236204	Alloy Steel	Painted Orange	1 T	CC-3	T7502101
3	3942305IL	236792	Carbon Steel	Painted Blue	1 T	CC-3	T7502101
3	3952315IL	236747	Alloy Steel	Painted Orange	1-1/2 T	CC-3	T7502101
4	3942405IL	239243	Carbon Steel	Painted Blue	1-1/2 T	CC-4	7506495
4	3952415IL	239250	Alloy Steel	Painted Orange	2 T	CC-4	7506495
5	3942505IL	238017	Carbon Steel	Painted Blue	2 T	CC-4	7506495
5	3952515IL	238000	Alloy Steel	Painted Orange	3 T	CC-4	7506495
7	3942705IL	240485	Carbon Steel	Painted Blue	3 T	CC-5	7506695
7	3952715IL	240454	Alloy Steel	Painted Orange	4-1/2 T	CC-5	7506695
9	3942905IL	240478	Carbon Steel	Painted Blue	5 T	CC-7	7506895
9	3952915IL	240447	Alloy Steel	Painted Orange	7 T	CC-7	7506895
11	3953115PL	295614	Alloy Steel	Painted Orange	11 T	PL-8	7507095PL
12	3953215IL	240423	Alloy Steel	Painted Orange	15 T	CC-9	7507295
12	3953215PL	295652	Alloy Steel	Painted Orange	15 T	PL-9	7507295PL

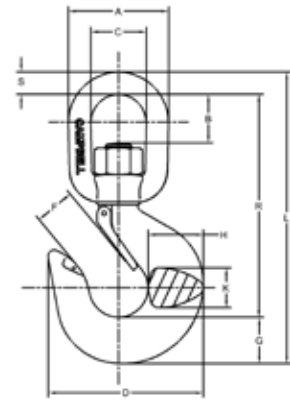

Trade Size	Catalog No.	A Dim.	B Dim.	C Dim.	D Dim.	F Dim.	G Dim.	H Dim.	K Dim.	L Dim.	R Dim.	S Dim.
2	3942205IL	2 in	1 in	1-1/4 in	2-15/16 in	7/8 in	25/32 in	29/32 in	9/16 in	5-5/8 in	4-5/8 in	3/8 in
2	3952215IL	2 in	1 in	1-1/4 in	2-15/16 in	7/8 in	25/32 in	29/32 in	9/16 in	5-5/8 in	4-5/8 in	3/8 in
3	3942305IL	2-1/2 in	1-1/4 in	1-1/2 in	3-1/4 in	7/8 in	27/32 in	31/32 in	5/8 in	6-11/16 in	5-7/16 in	1/2 in
3	3952315IL	2-1/2 in	1-1/4 in	1-1/2 in	3-1/4 in	7/8 in	27/32 in	31/32 in	5/8 in	6-11/16 in	5-7/16 in	1/2 in
4	3942405IL	2-1/2 in	1-1/4 in	1-1/2 in	3-9/16 in	1-1/32 in	1-1/32 in	1-1/8 in	11/16 in	7-5/16 in	5-13/16 in	1/2 in
4	3952415IL	2-1/2 in	1-1/4 in	1-1/2 in	3-9/16 in	1-1/32 in	1-1/32 in	1-1/8 in	11/16 in	7-5/16 in	5-13/16 in	1/2 in
5	3942505IL	3 in	1-5/8 in	1-3/4 in	4 in	1-1/8 in	1-5/32 in	1-5/16 in	13/16 in	8-3/16 in	6-7/16 in	5/8 in
5	3952515IL	3 in	1-5/8 in	1-3/4 in	4 in	1-1/8 in	1-5/32 in	1-5/16 in	13/16 in	8-3/16 in	6-7/16 in	5/8 in
7	3942705IL	3-1/2 in	1-3/4 in	2 in	4-15/16 in	1-15/16 in	1-7/16 in	1-5/8 in	1-1/16 in	9-7/16 in	8 in	3/4 in
7	3952715IL	3-1/2 in	1-3/4 in	2 in	4-15/16 in	1-15/16 in	1-7/16 in	1-5/8 in	1-1/16 in	9-7/16 in	8 in	3/4 in
9	3942905IL	4-1/2 in	2-1/4 in	2-1/2 in	6-15/32 in	1-21/32 in	1-13/16 in	2-1/8 in	1-3/8 in	12-3/8 in	9-5/8 in	1 in
9	3952915IL	4-1/2 in	2-1/4 in	2-1/2 in	6-15/32 in	1-21/32 in	1-13/16 in	2-1/8 in	1-3/8 in	12-3/8 in	9-5/8 in	1 in
11	3953115IL	5-5/8 in	2-27/32 in	3-1/8 in	7-11/32 in	2 in	2-1/4 in	2-5/8 in	1-1/2 in	15 in	11-9/16 in	1-1/4 in
11	3953115PL	5-5/8 in	3-1/8 in	3-1/8 in	7-9/16 in	2-1/32 in	2-9/32 in	2-23/32 in	2 in	15-7/8 in	12-11/32 in	1-1/4 in
12	3943205IL	5-5/8 in	2-3/4 in	3-1/8 in	7-13/16 in	2-1/8 in	2-9/16 in	2-15/16 in	1-13/16 in	16-1/32 in	12-1/4 in	1-1/4 in
12	3953215IL	5-5/8 in	2-3/4 in	3-1/8 in	7-13/16 in	2-1/8 in	2-9/16 in	2-15/16 in	1-13/16 in	16-1/32 in	12-1/4 in	1-1/4 in
12	3953215PL	5-5/8 in	2-3/4 in	3-1/8 in	8-3/4 in	2-9/32 in	2-19/32 in	3-1/8 in	2-1/4 in	16-13/32 in	12-17/32 in	1-1/4 in

FITTINGS





## Eye Hoist Hooks - Latched, C-1015-S, C-1015-G, A-1015-0



- Drop Forged Carbon Steel or Alloy and Heat Treated
- Carbon Steel Hooks Painted Blue or Galvanized to ASTM A-153 Specifications; Alloy Hooks Are Painted Orange
- 5 to 1 Design Factor
- All Hooks Are Drilled for Integrated Latch Kits
- The Latch Is Only Designed to Retain Slings and Rigging Attachments. The Latch Must Not Support the Load.
- DO NOT EXCEED THE WORKING LOAD LIMIT

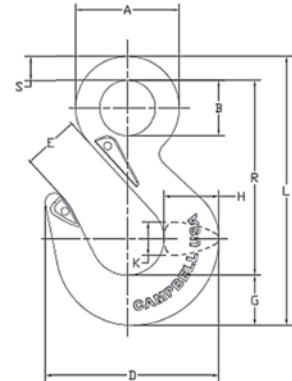

FITTINGS

Trade Size	Catalog No.	UPC No. 020418	Material	Finish	Working Load Limit (Short Tons)	Latch Marking	Replacement Latch No.	Weight Each
22	3914205IL	236211	Carbon Steel	Painted Blue	3/4 T	CC-3	T7502101	0.65 lb
22	3914235IL	236228	Carbon Steel	Galvanized	3/4 T	CC-3	T7502101	0.65 lb
22	3924215IL	236235	Alloy Steel	Painted Orange	1 T	CC-3	T7502101	0.65 lb
23	3914305IL	236785	Carbon Steel	Painted Blue	1 T	CC-3	T7502101	0.80 lb
23	3914335IL	236778	Carbon Steel	Galvanized	1 T	CC-3	T7502101	0.80 lb
23	3924315IL	236761	Alloy Steel	Painted Orange	1-1/2 T	CC-3	T7502101	0.80 lb
24	3914405IL	239274	Carbon Steel	Painted Blue	1-1/2 T	CC-4	7506495	1.05 lb
24	3914435IL	239267	Carbon Steel	Galvanized	1-1/2 T	CC-4	7506495	1.05 lb
24	3924415IL	239229	Alloy Steel	Painted Orange	2 T	CC-4	7506495	1.05 lb
25	3914505IL	237997	Carbon Steel	Painted Blue	2 T	CC-4	7506495	1.69 lb
25	3914535IL	237980	Carbon Steel	Galvanized	2 T	CC-4	7506495	1.69 lb
25	3924515IL	237973	Alloy Steel	Painted Orange	3 T	CC-4	7506495	1.69 lb
27	3914705IL	240713	Carbon Steel	Painted Blue	3 T	CC-5	7506695	4.00 lb
27	3914735IL	240690	Carbon Steel	Galvanized	3 T	CC-5	7506695	4.00 lb
27	3924715IL	240706	Alloy Steel	Painted Orange	4-1/2 T	CC-5	7506695	4.00 lb
29	3914905IL	240683	Carbon Steel	Painted Blue	5 T	CC-7	7506895	8.00 lb
29	3924915IL	240676	Alloy Steel	Painted Orange	7 T	CC-7	7506895	8.00 lb
31	3915105IL	240669	Carbon Steel	Painted Blue	7-1/2 T	CC-8	7507095	13.00 lb
31	3925115IL	240652	Alloy Steel	Painted Orange	11 T	CC-8	7507095	13.00 lb
32	3915205IL	240638	Carbon Steel	Painted Blue	10 T	CC-9	7507295	18.00 lb
32	3925215IL	240645	Alloy Steel	Painted Orange	15 T	CC-9	7507295	18.00 lb
34	3925415IL	240621	Alloy Steel	Painted Orange	22 T	CC-34	7507495	36.00 lb

Trade Size	Catalog No.	A Dim.	B Dim.	D Dim.	E Dim.	G Dim.	H Dim.	K Dim.	L Dim.	R Dim.	S Dim.
22	3914205IL	1-11/16 in	15/16 in	2-15/16 in	1-1/32 in	25/32 in	29/32 in	9/16 in	4-29/64 in	3-5/16 in	3/8 in
22	3914235IL	1-11/16 in	15/16 in	2-15/16 in	1-1/32 in	25/32 in	29/32 in	9/16 in	4-29/64 in	3-5/16 in	3/8 in
22	3924215IL	1-11/16 in	15/16 in	2-15/16 in	1-1/32 in	25/32 in	29/32 in	9/16 in	4-29/64 in	3-5/16 in	3/8 in
23	3914305IL	1-13/16 in	15/16 in	3-1/4 in	1-1/32 in	25/32 in	31/32 in	5/8 in	4-21/32 in	3-3/8 in	7/16 in
23	3914335IL	1-13/16 in	15/16 in	3-1/4 in	1-1/32 in	25/32 in	31/32 in	5/8 in	4-21/32 in	3-3/8 in	7/16 in
23	3924315IL	1-13/16 in	15/16 in	3-1/4 in	1-1/32 in	25/32 in	31/32 in	5/8 in	4-21/32 in	3-3/8 in	7/16 in
24	3914405IL	2-1/8 in	1-1/8 in	3-9/16 in	1-1/8 in	1-1/32 in	1-1/8 in	11/16 in	5-15/32 in	4 in	1/2 in
24	3914435IL	2-1/8 in	1-1/8 in	3-9/16 in	1-1/8 in	1-1/32 in	1-1/8 in	11/16 in	5-15/32 in	4 in	1/2 in
24	3924415IL	2-1/8 in	1-1/8 in	3-9/16 in	1-1/8 in	1-1/32 in	1-1/8 in	11/16 in	5-15/32 in	4 in	1/2 in
25	3914505IL	2-3/8 in	1-1/4 in	4 in	1-1/4 in	1-5/32 in	1-5/16 in	13/16 in	6-13/32 in	4-11/16 in	9/16 in

Continued on next page

Trade Size	Catalog No.	A Dim.	B Dim.	D Dim.	E Dim.	G Dim.	H Dim.	K Dim.	L Dim.	R Dim.	S Dim.
25	3914535IL	2-3/8 in	1-1/4 in	4 in	1-1/4 in	1-5/32 in	1-5/16 in	13/16 in	6-13/32 in	4-11/16 in	9/16 in
25	3924515IL	2-3/8 in	1-1/4 in	4 in	1-1/4 in	1-5/32 in	1-5/16 in	13/16 in	6-13/32 in	4-11/16 in	9/16 in
27	3914705IL	2-15/16 in	1-9/16 in	4-15/16 in	1-17/32 in	1-7/16 in	1-5/8 in	1-1/16 in	7-25/32 in	5-21/32 in	11/16 in
27	3914735IL	2-15/16 in	1-9/16 in	4-15/16 in	1-17/32 in	1-7/16 in	1-5/8 in	1-1/16 in	7-25/32 in	5-21/32 in	11/16 in
27	3924715IL	2-15/16 in	1-9/16 in	4-15/16 in	1-17/32 in	1-7/16 in	1-5/8 in	1-1/16 in	7-25/32 in	5-21/32 in	11/16 in
29	3914905IL	3-3/4 in	2 in	6-15/32 in	1-31/32 in	1-13/16 in	2-1/8 in	1-3/8 in	9-7/8 in	7-3/16 in	7/8 in
29	3924915IL	3-3/4 in	2 in	6-15/32 in	1-31/32 in	1-13/16 in	2-1/8 in	1-3/8 in	9-7/8 in	7-3/16 in	7/8 in
31	3915105IL	4-5/8 in	2-7/16 in	7-11/32 in	2-1/8 in	2-1/4 in	2-5/8 in	1-1/2 in	12-7/32 in	9 in	1-3/32 in
31	3925115IL	4-5/8 in	2-7/16 in	7-11/32 in	2-1/8 in	2-1/4 in	2-5/8 in	1-1/2 in	12-7/32 in	9 in	1-3/32 in
32	3915205IL	5-11/32 in	2-3/4 in	7-13/16 in	2-9/16 in	2-9/16 in	2-15/16 in	1-13/16 in	13-7/8 in	11-1/8 in	1-1/4 in
32	3925215IL	5-11/32 in	2-3/4 in	7-13/16 in	2-9/16 in	2-9/16 in	2-15/16 in	1-13/16 in	13-7/8 in	11-1/8 in	1-1/4 in
34	3925415IL	6-3/4 in	3-5/32 in	11-7/16 in	3-7/16 in	3-7/32 in	3-25/32 in	2-7/32 in	16-29/32 in	12-1/16 in	1-5/8 in

## Eye Hoist Hooks, C-1010-S, A-1010-O

- Drop Forged Carbon Steel or Alloy and Heat Treated
- Carbon Steel Hooks Are Painted Blue; Alloy Hooks Are Painted Orange
- 5 to 1 Design Factor
- All Hooks Are Drilled for Integrated Latch Kits
- The Latch Is Only Designed to Retain Slings and Rigging Attachments. The Latch Must Not Support the Load.
- DO NOT EXCEED THE WORKING LOAD LIMIT

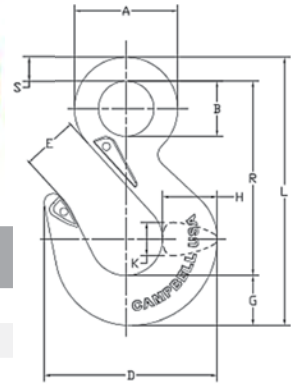

Trade Size	Catalog No.	UPC No. 020418	Material	Finish	Working Load Limit (Short Tons)	Latch Marking	Replacement Latch No.	Weight Each
27	3922715IL	240614	Alloy Steel	Painted Orange	4-1/2 T	CC-5	7506695	4.00 lb
29	3912905IL	240546	Carbon Steel	Painted Blue	5 T	CC-7	7506895	8.00 lb
29	3922915IL	240607	Alloy Steel	Painted Orange	7 T	CC-7	7506895	8.00 lb
31	3913105IL	240560	Carbon Steel	Painted Blue	7-1/2 T	CC-8	7507095	13.00 lb
31	3923115IL	240591	Alloy Steel	Painted Orange	11 T	CC-8	7507095	13.00 lb
32	3913205IL	240553	Carbon Steel	Painted Blue	10 T	CC-9	7507295	18.00 lb
32	3923215IL	240584	Alloy Steel	Painted Orange	15 T	CC-9	7507295	18.00 lb
34	3923415IL	240577	Alloy Steel	Painted Orange	22 T	CC-34	7507495	36.00 lb

Trade Size	Catalog No.	A Dim.	B Dim.	D Dim.	E Dim.	G Dim.	H Dim.	K Dim.	L Dim.	R Dim.	S Dim.
27	3922715IL	2-15/16 in	1-9/16 in	4-15/16 in	1-17/32 in	1-7/16 in	1-5/8 in	1-1/16 in	7-25/32 in	5-21/32 in	11/16 in
29	3912905IL	3-3/4 in	2 in	6-15/32 in	1-31/32 in	1-13/16 in	2-1/8 in	1-3/8 in	9-7/8 in	7-3/16 in	7/8 in
29	3922915IL	3-3/4 in	2 in	6-15/32 in	1-31/32 in	1-13/16 in	2-1/8 in	1-3/8 in	9-7/8 in	7-3/16 in	7/8 in
31	3913105IL	4-5/8 in	2-7/16 in	7-11/32 in	2-1/8 in	2-1/4 in	2-5/8 in	1-1/2 in	12-7/32 in	9 in	1-3/32 in
31	3923115IL	4-5/8 in	2-7/16 in	7-11/32 in	2-1/8 in	2-1/4 in	2-5/8 in	1-1/2 in	12-7/32 in	9 in	1-3/32 in
32	3913205IL	5-11/32 in	2-3/4 in	7-13/16 in	2-9/16 in	2-9/16 in	2-15/16 in	1-13/16 in	13-7/8 in	11-1/8 in	1-1/4 in
32	3923215IL	5-11/32 in	2-3/4 in	7-13/16 in	2-9/16 in	2-9/16 in	2-15/16 in	1-13/16 in	13-7/8 in	11-1/8 in	1-1/4 in
34	3923415IL	6-3/4 in	3-5/32 in	11-7/16 in	3-7/16 in	3-7/32 in	3-25/32 in	2-7/32 in	16-29/32 in	12-1/16 in	1-5/8 in

FITTINGS



## Snap Hooks, C-478-G

- Drop Forged Heat-Treated Carbon Steel
- Galvanized to ASTM A-153 Specifications
- 5 to 1 Design Factor
- Made in the USA

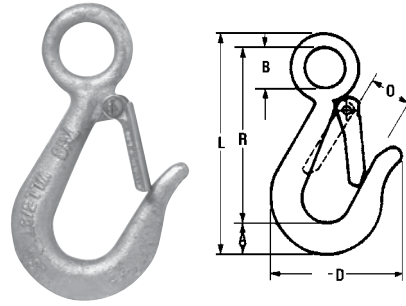

Trade Size	Catalog No.	UPC No. 020418	Finish	Working Load Limit	Replacement Latch No.	B Dim.	D Dim.	L Dim.	O Dim.	R Dim.	Weight Each	Shelf Pack
7/16 in	4530734	176722	Hot Galvanized	750 lb	3991401	3/4 in	2-7/16 in	4-1/16 in	21/32 in	3-1/4 in	0.28 lb	10
7/16 in	4530735	074196	Hot Galvanized	750 lb	3991401	3/4 in	2-7/16 in	4-1/16 in	21/32 in	3-1/4 in	0.28 lb	-
9/16 in	4530935	074202	Hot Galvanized	1000 lb	3991402	1-1/8 in	2-31/32 in	5-1/32 in	1 in	4-1/32 in	0.45 lb	-

## Sorting Hooks, A-479-0

- Drop Forged Heat-Treated Alloy Steel
- 5 to 1 Design Factor
- Available with Handle for Safety and Control
- Made in the USA
- Handle is Not to Be Used for Supporting Load



Catalog No.	UPC No. 020418	Finish	Working Load Limit - Bottom	Working Load Limit - Tip	B Dim.	L Dim.	O Dim.	R Dim.	Weight Each
3899500	070723	Painted Orange	7-1/2 T	2 T	1-3/8 in	9-3/4 in	2-13/16 in	5/8 in	6.00 lb
3899501	193040	Painted Orange	7-1/2 T	2 T	1-3/8 in	9-3/4 in	2-13/16 in	5/8 in	6.25 lb

## Eye Grab Hooks, Grade 43, (Import)

- Forged Steel
- Grade 43
- Grab Hooks Are Designed to Grab a Chain Link and Hold it in Place
- DO NOT EXCEED THE WORKING LOAD LIMIT



Trade Size	Catalog No.	UPC No. 020418	Hook Style	Finish	Working Load Limit	Weight Each	Shelf Pack	Case Pack
1/4 in	T9001424	222139	Eye	Zinc Plated	2600 lb	0.34 lb	10	100
5/16 in	T9001524	222146	Eye	Zinc Plated	3900 lb	0.55 lb	10	50
3/8 in	T9001624	222153	Eye	Zinc Plated	5400 lb	0.90 lb	10	50
1/2 in	T9001824	222122	Eye	Zinc Plated	9200 lb	1.80 lb	5	20

## Clevis Grab Hooks, Grade 43, (Import)

- Forged Steel
- Grade 43
- Grab Hooks Are Designed to Grab a Chain Link and Hold it in Place
- Hooks are Sized by the Material Diameter of the Chain That They Engage. Make Sure the Hook Size and Chain Diameter are Compatible Before Attaching to Load
- DO NOT EXCEED THE WORKING LOAD LIMIT



FITTINGS

Trade Size	Catalog No.	UPC No. 020418	For Chain Size	Hook Style	Finish	Working Load Limit	Weight Each	Shelf Pack	Case Pack
1/4 in	T9501424	192678	1/4 in	Clevis	Zinc Plated	2600 lb	0.43 lb	10	100
5/16 in	T9501524	192685	5/16 in	Clevis	Zinc Plated	3900 lb	0.73 lb	10	50
3/8 in	T9501624	192692	3/8 in	Clevis	Zinc Plated	5400 lb	1.11 lb	10	50
1/2 in	T9501824	220661	1/2 in	Clevis	Zinc Plated	9200 lb	1.85 lb	5	20

## Clevis Grab Hooks, Grade 70, (Import)

- Forged Steel
- Transport Grade
- Grab Hooks Are Designed to Grab a Chain Link and Hold it in Place
- Hooks are Sized by the Material Diameter of the Chain That They Engage. Make Sure the Hook Size and Chain Diameter are Compatible Before Attaching to Load



Trade Size	Catalog No.	UPC No. 020418	For Chain Size	Hook Style	Finish	Working Load Limit	Weight Each	Shelf Pack	Case Pack
1/4 in	T9503315	289316	1/4 in	Clevis	Yellow Chromate	3150 lb	0.43 lb	10	100
5/16 in	T9503415	201974	5/16 in	Clevis	Yellow Chromate	4700 lb	0.71 lb	10	50
3/8 in	T9503515	201981	3/8 in	Clevis	Yellow Chromate	6600 lb	1.18 lb	5	25



## Clevis Grab Hooks, C-473-S, C-473-Z, A-473-O

- Material is Drop-Forged Carbon Steel (Grade 30 & 43) or Heat-Treated Alloy Steel
- Grade 30 & 43 Hooks Available Self-Colored or Zinc-Plated
- Alloy Hooks Are Painted Orange and Stamped "Alloy"; 3.5 to 1 Design Factor
- Alloy Hook Sizes 1/4" to 3/8" are Supplied Individually Bagged and Unassembled
- Self-Colored Finish Hooks Are Bulk Packed, Zinc Plated Hooks Are Packed 10 Per Box
- Grab Hooks Are Designed to Grab a Chain Link and Hold it in Place
- Hooks are Sized by the Material Diameter of the Chain That They Engage. Make Sure the Hook Size and Chain Diameter are Compatible Before Attaching to Load
- DO NOT EXCEED THE WORKING LOAD LIMIT

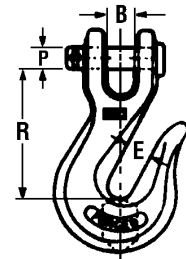

FITTINGS

Trade Size	Catalog No.	UPC No. 020418	Material	Finish	Working Load Limit	B Dim.	E Dim.	P Dim.	R Dim.	Weight Each	Shelf Pack
1/4 in	4500404	073878	Carbon Steel	Self-Colored	2600 lb	3/8 in	11/32 in	5/16 in	1-23/32 in	0.38 lb	10
1/4 in	4500405	073885	Carbon Steel	Self-Colored	2600 lb	3/8 in	11/32 in	5/16 in	1-23/32 in	0.38 lb	-
1/4 in	4500424	073892	Carbon Steel	Zinc Plated	2600 lb	3/8 in	11/32 in	5/16 in	1-23/32 in	0.38 lb	10
1/4 in	4503315	074103	Alloy Steel	Painted Orange	4100 lb	3/8 in	11/32 in	5/16 in	1-23/32 in	0.38 lb	-
5/16 in	4500504	073915	Carbon Steel	Self-Colored	3900 lb	15/32 in	7/16 in	3/8 in	1-31/32 in	0.60 lb	10
5/16 in	4500505	073922	Carbon Steel	Self-Colored	3900 lb	15/32 in	7/16 in	3/8 in	1-31/32 in	0.60 lb	-
5/16 in	4500524	073939	Carbon Steel	Zinc Plated	3900 lb	15/32 in	7/16 in	3/8 in	1-31/32 in	0.60 lb	10
5/16 in	4503415	074110	Alloy Steel	Painted Orange	5100 lb	15/32 in	7/16 in	3/8 in	1-31/32 in	0.60 lb	-
3/8 in	4500604	073953	Carbon Steel	Self-Colored	5400 lb	17/32 in	1/2 in	7/16 in	2-1/4 in	0.92 lb	-
3/8 in	4500605	073960	Carbon Steel	Self-Colored	5400 lb	17/32 in	1/2 in	7/16 in	2-1/4 in	0.92 lb	-
3/8 in	4500624	073977	Carbon Steel	Zinc Plated	5400 lb	17/32 in	1/2 in	7/16 in	2-1/4 in	0.92 lb	-
3/8 in	4503515	074127	Alloy Steel	Painted Orange	7100 lb	17/32 in	1/2 in	7/16 in	2-1/4 in	0.92 lb	-
7/16 in	4503615	074134	Alloy Steel	Painted Orange	10000 lb	19/32 in	19/32 in	1/2 in	2-5/8 in	1.50 lb	-
1/2 in	4500804	074035	Carbon Steel	Self-Colored	9200 lb	21/32 in	21/32 in	9/16 in	3-1/64 in	2.00 lb	-
1/2 in	4500805	074042	Carbon Steel	Self-Colored	9200 lb	21/32 in	21/32 in	9/16 in	3-1/64 in	2.00 lb	-
1/2 in	4503715	074141	Alloy Steel	Painted Orange	12000 lb	21/32 in	21/32 in	9/16 in	3-1/64 in	2.00 lb	-
5/8 in	4501005	074073	Carbon Steel	Self-Colored	11500 lb	13/16 in	25/32 in	3/4 in	3-25/32 in	3.90 lb	-
5/8 in	4503815	074158	Alloy Steel	Painted Orange	18100 lb	13/16 in	25/32 in	3/4 in	3-25/32 in	3.90 lb	-
3/4 in	4503915	074165	Alloy Steel	Painted Orange	28300 lb	15/16 in	15/16 in	13/16 in	4-25/32 in	6.34 lb	-

## Eye Slip Hooks, Grade 43, (Import)

- Forged Steel
- UPC Tagged
- Slip Hooks Are Designed to Allow Chain to Slip Through the Hook
- DO NOT EXCEED THE WORKING LOAD LIMIT



Trade Size	Catalog No.	UPC No. 020418	Hook Style	Finish	Working Load Limit	Weight Each	Shelf Pack	Case Pack
1/4 in	T9101424	222177	Eye	Zinc Plated	2600 lb	0.40 lb	10	100
5/16 in	T9101524	222184	Eye	Zinc Plated	3900 lb	0.70 lb	10	50
3/8 in	T9101624	222191	Eye	Zinc Plated	5400 lb	1.00 lb	10	50
1/2 in	T9101824	222160	Eye	Zinc Plated	9200 lb	2.60 lb	5	20

## Clevis Slip Hooks, Grade 43, (Import)

- Forged Steel
- Grade 43
- Slip Hooks Are Designed to Allow Chain to Slip Through the Hook
- Hooks are Sized by the Material Diameter of the Chain That They Engage. Make Sure the Hook Size and Chain Diameter are Compatible Before Attaching to Load

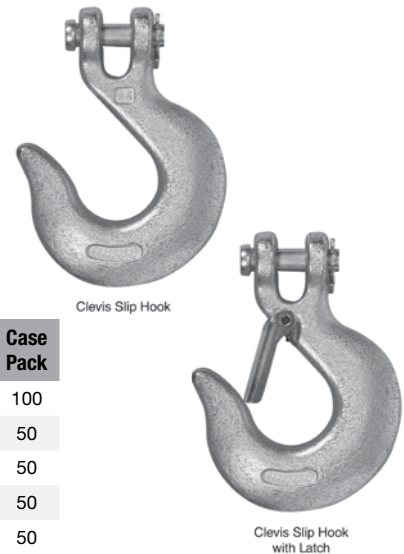

Trade Size	Catalog No.	UPC No. 020418	For Chain Size	Hook Style	Finish	Working Load Limit	Weight Each	Shelf Pack	Case Pack
1/4 in	T9401424	192647	1/4 in	Clevis	Zinc Plated	2600 lb	0.55 lb	5	100
1/4 in	T9700424	192081	1/4 in	Clevis w/ Latch	Zinc Plated	2600 lb	0.65 lb	5	50
5/16 in	T9401524	192654	5/16 in	Clevis	Zinc Plated	3900 lb	0.79 lb	5	50
5/16 in	T9700524	192098	5/16 in	Clevis w/ Latch	Zinc Plated	3900 lb	0.85 lb	5	50
3/8 in	T9401624	192661	3/8 in	Clevis	Zinc Plated	5400 lb	1.41 lb	5	50
3/8 in	T9700624	192104	3/8 in	Clevis w/ Latch	Zinc Plated	5400 lb	1.41 lb	5	30
1/2 in	T9401824	220654	1/2 in	Clevis	Zinc Plated	9200 lb	2.87 lb	5	15
1/2 in	T9700824	220647	1/2 in	Clevis w/ Latch	Zinc Plated	9200 lb	2.88 lb	5	15

## Clevis Slip Hooks, Grade 70, (Import)

- Forged Steel
- Transport Grade
- Slip Hooks Are Designed to Allow Chain to Slip Through the Hook
- Hooks are Sized by the Material Diameter of the Chain That They Engage. Make Sure the Hook Size and Chain Diameter are Compatible Before Attaching to Load



Trade Size	Catalog No.	UPC No. 020418	For Chain Size	Hook Style	Finish	Working Load Limit	Weight Each	Shelf Pack	Case Pack
1/4 in	T9504315	289323	1/4 in	Clevis w/ Latch	Yellow Chromate	3150 lb	0.65 lb	5	50
5/16 in	T9504415	289330	5/16 in	Clevis w/ Latch	Yellow Chromate	4700 lb	0.85 lb	5	50
3/8 in	T9504515	289347	3/8 in	Clevis w/ Latch	Yellow Chromate	6600 lb	1.41 lb	5	30



## Clevis Slip Hooks, A-476-0

- Material is Heat-Treated Alloy Steel
- Alloy Hooks Are Stamped "AH"
- 1/4" to 3/8" Hooks Have Drilled Hole for Latch Kit
- Design Factor: 3.5 to 1
- Slip Hooks Are Designed to Allow Chain to Slip Through the Hook
- Hooks are Sized by the Material Diameter of the Chain That They Engage. Make Sure the Hook Size and Chain Diameter are Compatible Before Attaching to Load
- DO NOT EXCEED THE WORKING LOAD LIMIT

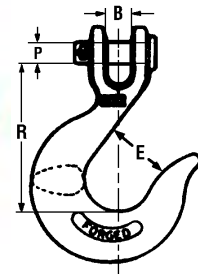

Trade Size	Catalog No.	UPC No. 020418	Material	Finish	Working Load Limit	B Dim.	E Dim.	P Dim.	R Dim.	Weight Each
1/4 in	4403315	073816	Alloy Steel	Painted Orange	4100 lb	3/8 in	15/16 in	5/16 in	1-23/32 in	0.60 lb
5/16 in	4403415	073823	Alloy Steel	Painted Orange	5100 lb	7/16 in	1-1/16 in	3/8 in	3 in	0.90 lb
3/8 in	4403515	073830	Alloy Steel	Painted Orange	7100 lb	1/2 in	1-1/4 in	7/16 in	3-13/32 in	1.44 lb
7/16 in	4403615	073847	Alloy Steel	Painted Orange	10000 lb	9/16 in	1-1/2 in	1/2 in	3-5/8 in	2.12 lb
1/2 in	4403715	073854	Alloy Steel	Painted Orange	13000 lb	5/8 in	1-3/4 in	9/16 in	4-3/32 in	3.12 lb
5/8 in	4403815	073861	Alloy Steel	Painted Orange	20300 lb	3/4 in	2 in	3/4 in	4-13/16 in	5.00 lb

## Latch Kits for Non-Integrated Hooks

Campbell offers latches already assembled to the hook as well as kits for field installation.

- Clapper latches are zinc-plated
- Spring spacer adapts latch to hooks with narrow cam
- Bolt and nut permit fast, easy installation



**916-G LATCH KIT  
FOR CAMPBELL HOOK**

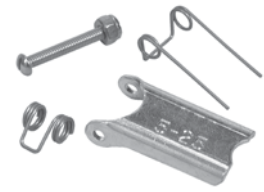

**916-U UNIVERSAL  
LATCH KIT –  
FOR ALL MAJOR HOOK BRANDS**

**READ AND UNDERSTAND THESE WARNINGS AND INSTRUCTIONS BEFORE USING HOOK AND LATCH.**

### IMPORTANT: Instructions For Use

1. Always inspect the hook and latch before using.
2. Always make sure the spring forces the latch against the point of the hook.
3. Check the load before lifting to make sure the hook (not the latch) is supporting the load.
4. To assemble latches on hooks, follow instructions supplied with kit.

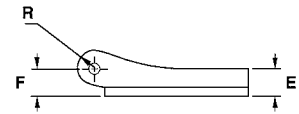
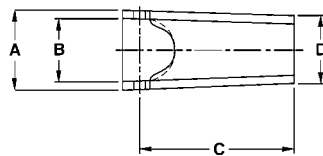

**NOTE:** Latches listed on this page cannot be used on Campbell's current design of integrated Sling and Hoist hooks. Please refer to the appropriate catalog pages for these hooks for proper replacement latch kits.

Size in.	Size mm	Size No.	916-G Kit		Universal Kit		Dimensions												Weight/ 100			
			Cat. No.	UPC No. 020418	Cat. No.	UPC No. 020418	A in.	B mm	C in.	D mm	E in.	F mm	R in.	lb	kg							
1/4	6	2-22	3990101	072727	3991401	177088	23/32	18	9/16	14	1 1/4	32	5/8	16	1/4	6	1/4	6	5/32	4	3.3	1
5/16	8	3-23	3990201	072734	3991402	177095	23/32	18	9/16	14	1 3/8	39	39/64	16	1/4	6	1/4	6	5/32	4	3.7	2
--	--	4-24	3990301	072741	3991403	177101	15/16	24	25/32	20	1 17/32	43	15/16	24	9/32	7	9/32	7	3/16	5	5	2
3/8	10	5-25	3990401	072758	3991404	177118	15/16	24	25/32	20	1 11/16	43	15/16	24	9/32	7	9/32	7	3/16	5	5.6	3
--	--	6-26	3990501	072765	--	--	15/16	24	25/32	20	1 31/32	50	15/16	24	9/32	7	9/32	7	3/16	5	6.2	3
7/16	11	7-27	3990601	072772	3991405	177125	15/16	24	25/32	20	1 7/8	48	15/16	24	9/32	7	9/32	7	3/16	5	6.5	3
--	--	8-28	3990701	072789	--	--	1 9/32	32	1	25	2 3/8	60	1 9/32	32	3/8	10	9/16	14	17/64	7	12	5
1/2	13	9-29	3990801	072796	3991406	177132	1 9/32	32	1	25	2 11/16	68	1 9/32	32	3/8	10	9/16	14	17/64	7	16.5	7
--	--	10-30	3990901	072802	--	--	1 9/32	32	1	25	2 31/32	75	1 9/32	32	3/8	10	9/16	14	17/64	7	18.2	8
5/8	16	11-31	3991001	072819	3991407	177149	1 9/32	32	1	25	3 7/32	82	1 9/32	32	3/8	10	9/16	14	17/64	7	36	16
--	--	12-32	3991101	072826	3991408	177156	2	51	1 17/32	39	3 7/16	87	1 5/8	41	9/16	14	23/32	18	3/8	10	52	24
--	--	34	--	--	3991409	177163	2 3/16	56	1 3/4	45	4 11/32	110	1 3/4	45	9/16	14	11/16	18	13/32	10	70.7	32

### WARNING

- Failure to follow the Instructions For Use and these warnings may cause death or serious injury.
- Loads may disengage from hook if proper procedures are not followed.
- A falling load may cause serious injury or death.
- The load must never be supported by the latch.
- Latches must always be inspected for wear or damage before use. If worn, distorted or damaged, discard and replace.
- Always stand clear of loads being lifted.





## Swivels

Campbell carbon swivels are all drop-forged and normalized. They meet the design requirements of Federal Specification RR-C-271. Galvanizing is to ASTM A153 specification.

(1st letter indicates material, number is type, last letter indicates finish)

Eye & Eye      C-272-G

Jaw & Eye      C-275-G



EYE AND EYE SWIVEL



JAW AND EYE SWIVEL

**READ AND UNDERSTAND THESE WARNINGS AND INSTRUCTIONS BEFORE USING SWIVELS.**

### IMPORTANT: Instructions For Use

1. These swivels are designed for a straight line pull only.
2. These swivels are not designed to swivel under load.
3. Do not exceed working load limit (WLL). See table right.

### Working Load Limits - Swivels

Size		Carbon WLL	
in.	mm	lb	kg
1/4	6	850	386
5/16	8	1250	568
3/8	10	2250	1022
1/2	13	3600	1634
5/8	16	5200	2361
3/4	19	7200	3269
7/8	22	10,000	4540
1	25	12,500	5675
1 1/4	32	18,000	8172

### WARNING

- Failure to follow the Instructions For Use below and these warnings may cause death or serious injury.
- Use swivels only as indicated.
- Swivels must always be inspected for wear, distortion and damage before use. If worn, distorted or damaged, discard and replace.
- Always stand clear of loads being lifted.
- Do not angle load.



## Drop Forged Eye & Eye Swivels, Galvanized, C-272-G

- Drop-Forged Carbon Steel
- Galvanized to ASTM A-153 Specification
- Design Factor: 5 to 1
- Meets Federal Specification RR-C-271 Type VII, Class 2
- Swivels Are Designed For Straight Line Pull Only
- These Swivels ARE NOT Designed to Swivel Under Load
- DO NOT EXCEED THE WORKING LOAD LIMIT

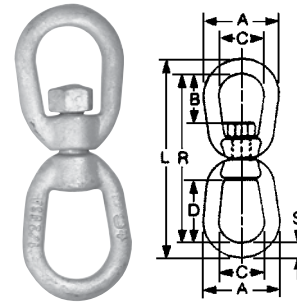

Trade Size	Catalog No.	UPC No. 020418	Working Load Limit	A Dim.	B Dim.	C Dim.	D Dim.	L Dim.	R Dim.	S Dim.	Weight Each
1/4 in	3630435	069901	850 lb	1-1/4 in	3/4 in	3/4 in	1-1/16 in	3-3/8 in	2-7/8 in	1/4 in	0.16 lb
5/16 in	3630535	069918	1250 lb	1-5/8 in	3/4 in	1 in	1-1/4 in	4-1/8 in	3-5/8 in	5/16 in	0.29 lb
3/8 in	3630635	069925	2250 lb	2 in	1 in	1-1/4 in	1-1/2 in	5 in	4-1/4 in	3/8 in	0.64 lb
1/2 in	3630835	069932	3600 lb	2-1/2 in	1-1/4 in	1-1/2 in	1-15/16 in	6-3/4 in	5-3/4 in	1/2 in	1.32 lb
5/8 in	3631035	069949	5200 lb	3 in	1-5/8 in	1-3/4 in	2-3/8 in	8 in	6-3/4 in	5/8 in	2.52 lb
3/4 in	3631235	069956	7200 lb	3-1/2 in	1-3/4 in	2 in	2-1/2 in	8-3/4 in	7-1/4 in	3/4 in	3.75 lb
7/8 in	3631435	069963	10000 lb	4 in	2-1/8 in	2-1/4 in	3-1/16 in	10-3/8 in	8-3/4 in	7/8 in	6.02 lb
1 in	3631635	069970	12500 lb	4-1/2 in	2-1/4 in	2-1/2 in	3-1/2 in	11-3/4 in	9-3/4 in	1 in	8.84 lb
1-1/4 in	3632035	069987	18000 lb	5-5/8 in	3-1/4 in	3-1/8 in	3-7/8 in	13-15/16 in	11-1/2 in	1-1/4 in	16.75 lb

## Eye & Eye Swivels (Import)

- Forged Steel
- Swivels Are Designed For Straight Line Pull Only
- These Swivels ARE NOT Designed to Swivel Under Load
- UPC Tagged
- DO NOT EXCEED THE WORKING LOAD LIMIT

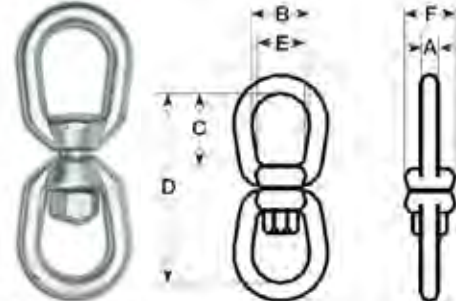

Trade Size	Catalog No.	UPC No. 020418	Finish	A Dim.	B Dim.	C Dim.	D Dim.	E Dim.	F Dim.	Working Load Limit	Weight Each	Shelf Pack	Case Pack
3/16 in	T9630335	211560	Galvanized	0.20 in	0.70 in	0.81 in	2.52 in	0.62 in	0.64 in	700 lb	0.11 lb	5	50
1/4 in	T9630435	211577	Galvanized	0.25 in	0.73 in	1.02 in	3.00 in	0.65 in	0.69 in	850 lb	0.19 lb	5	50
5/16 in	T9630535	211584	Galvanized	0.33 in	0.97 in	1.18 in	3.64 in	0.77 in	0.84 in	1250 lb	0.37 lb	5	50
3/8 in	T9630635	211591	Galvanized	0.44 in	1.20 in	1.34 in	4.20 in	1.00 in	1.02 in	2250 lb	0.69 lb	5	25
1/2 in	T9630835	211607	Galvanized	0.55 in	1.46 in	1.88 in	5.44 in	1.16 in	1.28 in	3600 lb	1.39 lb	5	25

FITTINGS



## Drop Forged Jaw & Eye Swivels, Galvanized, C-275-G

- Drop-Forged Carbon Steel
- Galvanized to ASTM A-153 Specification
- Design Factor: 5 to 1
- Meets Federal Specification RR-C-271 Type VII, Class 3
- Swivels Are Designed For Straight Line Pull Only
- These Swivels ARE NOT Designed to Swivel Under Load
- DO NOT EXCEED THE WORKING LOAD LIMIT

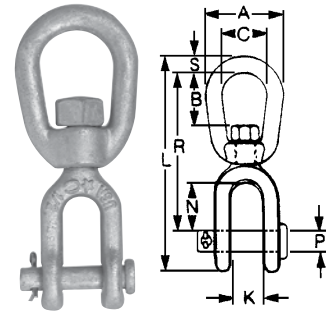

Trade Size	Catalog No.	UPC No. 020418	Working Load Limit	A Dim.	B Dim.	C Dim.	K Dim.	L Dim.	N Dim.	P Dim.	R Dim.	S Dim.	Weight Each
1/4 in	3640435	069994	850 lb	1-1/4 in	3/4 in	3/4 in	1/2 in	3-5/32 in	3/4 in	1/4 in	2-7/16 in	1/4 in	0.22 lb
5/16 in	3640535	070006	1250 lb	1-5/8 in	3/4 in	1 in	1/2 in	3-3/4 in	13/16 in	5/16 in	2-7/8 in	5/16 in	0.34 lb
3/8 in	3640635	070013	2250 lb	2 in	1 in	1-1/4 in	11/16 in	4-5/8 in	1-1/16 in	3/8 in	3-1/2 in	3/8 in	0.73 lb
1/2 in	3640835	070020	3600 lb	2-1/2 in	1-1/4 in	1-1/2 in	3/4 in	6-1/8 in	1-3/8 in	1/2 in	4-11/16 in	1/2 in	1.26 lb
5/8 in	3641035	070037	5200 lb	3 in	1-5/8 in	1-3/4 in	15/16 in	7-3/8 in	1-1/2 in	5/8 in	5-1/2 in	5/8 in	2.35 lb
3/4 in	3641235	070044	7200 lb	3-1/2 in	1-3/4 in	2 in	1-1/8 in	8 in	1-3/4 in	3/4 in	5-7/8 in	3/4 in	3.50 lb
7/8 in	3641435	070051	10000 lb	4 in	2-1/8 in	2-1/4 in	1-3/16 in	9-3/8 in	2-1/16 in	7/8 in	7 in	7/8 in	5.80 lb
1 in	3641635	070068	12500 lb	4-1/2 in	2-1/4 in	2-1/2 in	1-3/4 in	11-7/16 in	2-7/16 in	1-1/8 in	8-5/8 in	1 in	9.50 lb
1-1/4 in	3642035	070075	18000 lb	5-5/8 in	3-1/4 in	3-1/8 in	2-1/16 in	13-1/2 in	2-13/16 in	1-3/8 in	8-7/16 in	1-1/4 in	16.75 lb

FITTINGS

## Thimbles

Campbell® thimbles are all made of hot rolled, mild steel. They are all galvanized to ASTM A-153 Specification.

Manila Rope C-83-G



HEAVY WIRE ROPE THIMBLE

Heavy Wire Rope C-765-G



MANILA ROPE THIMBLE

**READ AND UNDERSTAND THESE WARNINGS AND INSTRUCTIONS BEFORE USING THIMBLES.**

### IMPORTANT: Instructions For Use

1. A thimble is a wear pad that protects the rope from cuts and kinking. Always use an appropriate thimble when making an eye in a rope.
2. When it is necessary to open a thimble to insert a fitting, make sure the points are properly aligned when the thimble is closed. Inspect carefully for cracks.
3. Thimbles are not designed for load carrying purposes; therefore working load limits have not been established.

### WARNING

- Failure to follow the Instructions For Use below and these warnings may cause death or serious injury.
- Thimbles must always be inspected for cracks and wear before use. If worn, distorted or damaged, discard and replace.
- Use thimbles only as indicated.
- The thimble size must exactly correspond to the diameter of the rope being used. Never use a smaller thimble, because it will pinch the rope and cause broken and/or displaced wires.

## Manila Rope Thimbles, Galvanized

- Standard Material: Hot Rolled, Mild Steel
- Galvanized to Meet ASTM A-153 Specifications
- Meets Design Requirements of Federal Specifications FF-T-276C, Type 1
- A Thimble is a Wear Pad That Protects the Rope From Cuts, Kinking and Abrasions. Always Use An Appropriate Thimble When Making An Eye in a Rope.
- When it is Necessary to Open a Thimble to Insert a Fitting, Make Sure the Points are Properly Aligned When the Thimble is Closed. Inspect Carefully for Cracks.
- Thimbles ARE NOT Designed for Load Carrying Purposes; Therefore Working Load Limits Have Not Been Established.

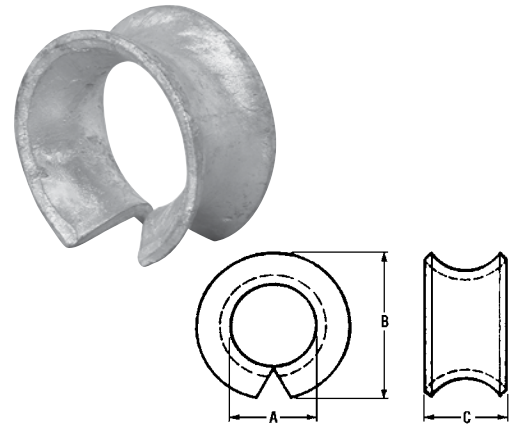

For Rope Diameter	Catalog No.	UPC No. 020418	Pin Diameter	A Dim.	B Dim.	C Dim.	Weight Each	Shelf Pack
3/8 in	6260301	091827	7/16 in	1/2 in	1 in	1/2 in	0.03 lb	-
3/8 in	6260301N	299339	7/16 in	1/2 in	1 in	1/2 in	0.03 lb	10
1/2 in	6260302	091834	11/16 in	3/4 in	1-5/16 in	23/32 in	0.10 lb	-
1/2 in	6260302N	299346	11/16 in	3/4 in	1-5/16 in	23/32 in	0.10 lb	10
5/8 in	6260303	091841	13/16 in	7/8 in	1-1/2 in	3/4 in	0.11 lb	-
5/8 in	6260303N	299353	13/16 in	7/8 in	1-1/2 in	3/4 in	0.11 lb	10
3/4 in	6260304	091858	1-1/16 in	1-1/8 in	1-13/16 in	31/32 in	0.16 lb	-
3/4 in	6260304N	299360	1-1/16 in	1-1/8 in	1-13/16 in	31/32 in	0.16 lb	10

## Heavy Wire Rope Thimbles, Galvanized, C-765-G

- Standard Material: Hot Rolled, Mild Steel
- Galvanized
- Imported
- A Thimble is a Wear Pad That Protects the Rope From Cuts, Kinking and Abrasions. Always Use An Appropriate Thimble When Making An Eye in a Rope.
- When it is Necessary to Open a Thimble to Insert a Fitting, Make Sure the Points are Properly Aligned When the Thimble is Closed. Inspect Carefully for Cracks.
- Thimbles ARE NOT Designed for Load Carrying Purposes; Therefore Working Load Limits Have Not Been Established.

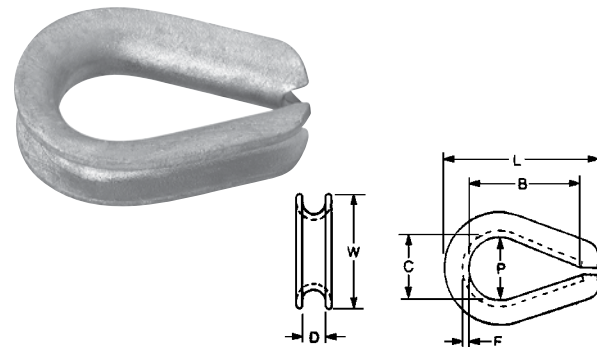

Trade Size	Catalog No.	UPC No. 020418	For Wire Rope Size	B Dim.	C Dim.	D Dim.	F Dim.	L Dim.	P Dim.	W Dim.	Weight Each
1/4 in	6260201	091711	1/4	1-5/8 in	7/8 in	9/32 in	1/16 in	2-1/8 in	13/16 in	1-1/2	0.07 lb
5/16 in	6260202	091728	5/16	1-7/8 in	1-1/16 in	3/8 in	5/64 in	2-1/2 in	15/16 in	1-13/16	0.12 lb
3/8 in	6260203	091735	3/8	2-1/8 in	1-1/8 in	7/16 in	7/64 in	3 in	1-1/16 in	2-1/8	0.19 lb
1/2 in	6260205	091759	1/2 to 9/16	2-3/4 in	1-1/2 in	5/8 in	9/64 in	3-5/8 in	1-7/16 in	2-11/16	0.49 lb
5/8 in	6260206	091766	5/8	3-1/4 in	1-3/4 in	11/16 in	5/32 in	4-1/4 in	1-5/8 in	3-1/8	0.72 lb
3/4 in	6260207	091773	3/4	3-3/4 in	2 in	13/16 in	7/32 in	5 in	1-7/8 in	3-13/16	1.41 lb
7/8 in	6260208	091780	7/8	4-1/4 in	2-1/4 in	15/16 in	7/32 in	5-1/2 in	2-1/8 in	4-1/4	1.85 lb
1 in	6260209	091797	1	4-1/2 in	2-1/2 in	1-1/16 in	1/4 in	6-1/8 in	2-3/8 in	4-15/16	3.00 lb
1-1/8 in	6260210	091803	1-1/8 to 1-1/4	5-1/8 in	2-7/8 in	1-5/16 in	1/4 in	7 in	2-3/4 in	5-7/8	3.68 lb

FITTINGS



## Weldless Sling Links – C-821-S, C-821-G, A-821-O

Campbell® links are all drop-forged and heat treated. Galvanizing is to ASTM A-153 specification.



SLING LINK

**READ AND UNDERSTAND THESE WARNINGS AND INSTRUCTIONS BEFORE USING THESE LINKS.**

**IMPORTANT: Instructions For Use**

1. Make sure the link has a working load limit compatible with that of the chain or wire rope with which it is used.
2. Do not exceed WLL See table to the right.
3. The WLL can be significantly reduced under the following conditions:
  - Wear and/or Distortion
  - Extreme Heat
  - Weld Spatter
 If link is exposed to any of these conditions, discard it.

Working Load Limits (lb and kg) - Links						
Size		Sling Link				
in.	mm	Carbon WLL lb	kg	Alloy WLL lb	kg	
3/8	10	1600	726	2600	1180	
1/2	13	2900	1317	4000	1816	
5/8	16	4200	1907	5800	2633	
3/4	19	6000	2724	8200	3723	
7/8	22	8300	3768	--	--	
1	25	10800	4903	--	--	

**⚠ WARNING**

- Failure to follow the Instructions For Use below and these warnings may cause death or serious injury.
- Use links only as indicated.
- Links must always be inspected for wear and distortion before use. If worn, distorted or damaged, discard and replace.
- Do not weld on these links.
- Always stand clear of loads being lifted.



## Weldless Sling Links, C-821-S, C-821-G

- Drop-Forged Heat-Treated Carbon Steel
- 6 to 1 Design Factor
- Standard Finish is Painted Blue or Galvanized to Meet ASTM A-153 Specifications
- Make Sure the Link Has a Working Load Limit Compatible With That of the Chain or Wire Rope With Which it is Used.
- The Working Load Limit Can Be Significantly Reduced Under Wear and/or Distortion, Extreme Heat, and Weld Splatter. If the Link is Exposed to Any of These Conditions, Discard It.
- DO NOT WELD On These Links
- DO NOT EXCEED THE WORKING LOAD LIMIT

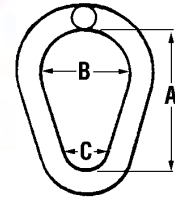

Trade Size	Catalog No.	UPC No. 020418	Material	Finish	Working Load Limit	A Dim.	B Dim.	C Dim.	Weight Each
3/8 in	3625115	069703	Carbon Steel	Painted Blue	1600 lb	2-1/4 in	1-1/2 in	3/4 in	0.23 lb
3/8 in	3625135	069710	Carbon Steel	Galvanized	1600 lb	2-1/4 in	1-1/2 in	3/4 in	0.30 lb
1/2 in	3625215	069727	Carbon Steel	Painted Blue	2900 lb	3 in	2 in	1 in	0.60 lb
1/2 in	3625235	069734	Carbon Steel	Galvanized	2900 lb	3 in	2 in	1 in	0.50 lb
5/8 in	3625315	069741	Carbon Steel	Painted Blue	4200 lb	3-3/4 in	2-1/2 in	1-1/4 in	1.10 lb
5/8 in	3625335	069758	Carbon Steel	Galvanized	4200 lb	3-3/4 in	2-1/2 in	1-1/4 in	1.10 lb
3/4 in	3625415	069765	Carbon Steel	Painted Blue	6000 lb	4-1/2 in	3 in	1-1/2 in	1.90 lb
3/4 in	3625435	069772	Carbon Steel	Galvanized	6000 lb	4-1/2 in	3 in	1-1/2 in	1.90 lb
7/8 in	3625515	069789	Carbon Steel	Painted Blue	8300 lb	5-1/4 in	3-1/2 in	1-3/4 in	2.90 lb
7/8 in	3625535	069796	Carbon Steel	Galvanized	8300 lb	5-1/4 in	3-1/2 in	1-3/4 in	2.90 lb
1 in	3625615	069802	Carbon Steel	Painted Blue	10800 lb	6 in	4 in	2 in	4.30 lb
1 in	3625635	069819	Carbon Steel	Galvanized	10800 lb	6 in	4 in	2 in	4.30 lb

FITTINGS

## Weldless Sling Links, A-821-0

- Drop-Forged Heat-Treated Alloy Steel
- 6 to 1 Design Factor
- Standard Finish is Painted Orange
- Make Sure the Link Has a Working Load Limit Compatible With That of the Chain or Wire Rope With Which it is Used.
- The Working Load Limit Can Be Significantly Reduced Under Wear and/or Distortion, Extreme Heat, and Weld Splatter. If the Link is Exposed to Any of These Conditions, Discard It.
- DO NOT WELD On These Links
- DO NOT EXCEED THE WORKING LOAD LIMIT

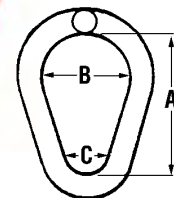

Trade Size	Catalog No.	UPC No. 020418	Material	Finish	Working Load Limit	A Dim.	B Dim.	C Dim.	Weight Each
3/8 in	3626115	069826	Alloy Steel	Painted Orange	2600 lb	2-1/4 in	1-1/2 in	3/4 in	0.23 lb
1/2 in	3626215	069833	Alloy Steel	Painted Orange	4000 lb	3 in	2 in	1 in	0.60 lb
5/8 in	3626315	069840	Alloy Steel	Painted Orange	5800 lb	3-3/4 in	2-1/2 in	1-1/4 in	1.10 lb



## Regular Nut Eyebolts – C-436-G

Campbell carbon steel eyebolts are all drop-forged and normalized. Galvanizing is to ASTM A-153 specification.

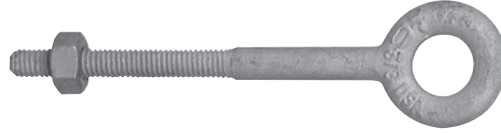

**REGULAR NUT EYEBOLT**

**READ AND UNDERSTAND THESE WARNINGS AND INSTRUCTIONS AND FOLLOW ALL EYEBOLT SAFETY INFORMATION PRESENTED HERE BEFORE USING EYEBOLT ASSEMBLIES.**

### **IMPORTANT: Instructions For Use**

1. Make sure the eyebolt is properly seated by screwing it down completely and tightening the nut securely against the load.
2. An eyebolt must be installed into a tapped hole with a minimum depth of two times the shank diameter.
3. Make sure the threads on the shank and in the hole are clean and undamaged.
4. Loads must always be applied parallel to the plane of the eye and never across the plane of the eye.
5. Always lift the load with a steady, even pull. Do not shock load.
6. Do not exceed working load limit (WLL). See table. The standard WLL's are established for a vertical pull.
7. Use only the heavy hex nuts supplied with the eyebolts.

### **⚠ WARNING**

- Failure to follow the Instructions For Use below and these warnings may cause death or serious injury.
- Loads may slip or fail if proper eyebolt assembly and lifting procedures are not used.
- A falling load can seriously injure or kill.
- Eyebolts must always be inspected for wear and distortion before use. If worn, distorted or damaged, discard and replace.
- Do not use regular nut eyebolts for angular lifting.
- Never machine, cut or grind an eyebolt.
- Always stand clear of loads being lifted.



## Regular Nut Eyebolts, C-436-G

- Drop-Forged Carbon Steel
- Working Load Limits Apply Only to Eyebolts in Lifting or Pulling Applications
- Regular Nut Eyebolts Are Not To Be Used For Angular Lifting.
- Galvanized to Meet ASTM A-153 Specifications
- Make Sure the Eyebolt is Properly Seated by Screwing It Down Completely and Tightening the Nut Securely Against the Load.
- Eyebolts Must Be Installed Into a Tapped Hole With a Minimum Depth of Two Times the Shank Diameter.
- Make Sure the Threads on the Shank and in the Hole are Clean and Undamaged.
- Always Lift the Load With a Steady, Even Pull. Do Not Shock Load
- Loads Must be Applied Parallel to the Plane of the Eye and Never Across the Plane of the Eye.
- DO NOT EXCEED THE WORKING LOAD LIMIT



Catalog No.	UPC No. 020418	Working Load Limit	A Dim.	B Dim.	L Dim.	S Dim.	T Dim.	Weight Each
7150106	100789	1250 lb	3/4 in	1-1/2 in	4-1/2 in	3/8 in	2-1/2 in	0.28 lb
7150107	100796	1250 lb	3/4 in	1-1/2 in	6 in	3/8 in	3 in	0.32 lb
7150108	100802	2250 lb	1 in	2 in	3-1/4 in	1/2 in	1-1/2 in	0.52 lb
7150109	100819	2250 lb	1 in	2 in	6 in	1/2 in	3 in	0.64 lb
7150111	100833	2250 lb	1 in	2 in	10 in	1/2 in	3 in	0.88 lb
7150112	100840	2250 lb	1 in	2 in	12 in	1/2 in	4 in	0.98 lb
7150114	100864	3600 lb	1-1/4 in	2-1/2 in	6 in	5/8 in	3 in	1.14 lb
7150115	100871	3600 lb	1-1/4 in	2-1/2 in	8 in	5/8 in	3 in	1.31 lb
7150116	100888	3600 lb	1-1/4 in	2-1/2 in	10 in	5/8 in	3 in	1.52 lb
7150117	100895	3600 lb	1-1/4 in	2-1/2 in	12 in	5/8 in	4 in	1.68 lb
7150119	100918	5200 lb	1-1/2 in	3 in	6 in	3/4 in	3 in	1.84 lb
7150120	100925	5200 lb	1-1/2 in	3 in	8 in	3/4 in	3 in	2.08 lb
7150121	100932	5200 lb	1-1/2 in	3 in	10 in	3/4 in	3 in	2.30 lb
7150122	100949	5200 lb	1-1/2 in	3 in	12 in	3/4 in	4 in	2.55 lb

FITTINGS

## Pad Eyes, C-20-S

- Widely Used on Farm Machinery, Trucks, Steel Hulled Marine Vessels and Material Handling Equipment
- Drop-Forged C-1038 Carbon Steel
- Standard Finish: Self-Colored

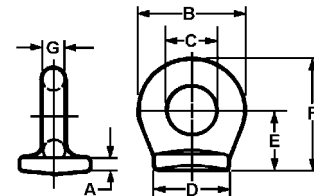

Trade Size	Catalog No.	UPC No. 020418	A Dim.	B Dim.	C Dim.	D Dim.	E Dim.	F Dim.	G Dim.	Weight Each
1-1/2 in	7105301	100697	5/32 in	1-1/8 in	5/8 in	1 in	3/4 in	1-5/16 in	1/4 in	0.08 lb
2 in	7105302	100703	3/16 in	1-1/2 in	3/4 in	1-1/16 in	7/8 in	1-5/8 in	3/8 in	0.17 lb
4 in	7105303	100710	1/4 in	2-1/8 in	1 in	1-7/16 in	1-1/4 in	2-5/16 in	9/16 in	0.50 lb
5 in	7105304	100727	15/16 in	2-5/8 in	1-1/4 in	1-3/4 in	1-9/16 in	2-7/8 in	11/16 in	0.93 lb





## Eye Nuts, Carbon Steel, Normalized, C-776-G



- Drop-Forged Carbon Steel Normalized
- Galvanized to Meet ASTM A-153 Specifications
- Design Factor: 5 to 1
- Do Not Exceed Working Load Limit (WLL). The Standard WLL's are established for a Vertical In-Line Pull
- Make Sure Eye Nuts are Properly Seated by Screwing them Down Completely
- Make Sure the Threads in the Hole are Clean and Undamaged
- Loads Must Always be Applied Parallel to the Plane of the Eye and Never Across the Plane
- Always Stand Clear of the Load and Lift the Load With a Steady, Even Pull. Do Not Shock Load

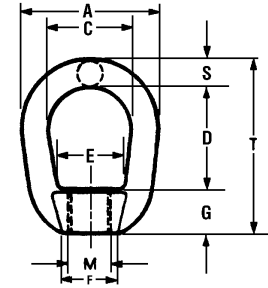

Size No.	Catalog No.	UPC No. 020418	Tap Size (M) UNC-2B	Working Load Limit	A Dim.	C Dim.	D Dim.	E Dim.	F Dim.	G Dim.	S Dim.	T Dim.	Weight Each
2	7100103	100420	3/8 in	1250 lb	1-5/8 in	1 in	1-17/64 in	3/4 in	9/16 in	15/32 in	5/16 in	2-3/64 in	0.20 lb
3A	7100105	100444	1/2 in	2250 lb	2 in	1-1/4 in	1-1/2 in	1 in	13/16 in	19/32 in	3/8 in	2-15/32 in	0.28 lb
4	7100106	100451	5/8 in	3600 lb	2-1/2 in	1-1/2 in	2-1/32 in	1-3/16 in	1 in	3/4 in	1/2 in	3-9/32 in	0.55 lb
5	7100107	100468	3/4 in	5200 lb	3 in	1-3/4 in	2-7/16 in	1-7/16 in	1-1/4 in	7/8 in	5/8 in	3-15/16 in	1.13 lb
6	7100108	100475	7/8 in	7200 lb	3-1/2 in	2 in	2-9/16 in	1-5/8 in	1-3/8 in	1 in	3/4 in	4-5/16 in	1.53 lb
7	7100109	100482	1 in	10000 lb	4 in	2-1/4 in	3-1/16 in	1-15/16 in	1-5/8 in	1-1/4 in	7/8 in	5-3/16 in	2.75 lb
8	7100111	100505	1-1/4 in	15200 lb	4-1/2 in	2-1/2 in	3-1/2 in	2-1/8 in	1-13/16 in	1-5/16 in	1 in	5-13/16 in	3.80 lb

## Turnbuckles

Campbell carbon turnbuckles are all drop-forged and meet the design requirements of Federal Specification ASTM F-1145, Type 1, Grade 1. All types, except stub-end, are galvanized to ASTM A153 specifications.



HOOK & EYE



EYE & EYE



JAW & JAW



JAW & EYE

Hook & Eye C-778-G    Jaw & Eye C-786-G  
 Eye & Eye C-780-G    Jaw & Jaw C-788-G

**READ AND UNDERSTAND THESE WARNINGS AND INSTRUCTIONS BEFORE USING TURNBUCKLES.**

### IMPORTANT: Instructions For Use

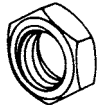
1. Turnbuckles are designed for a static load and are typically used with guy wires.
2. Do not exceed working load limit (WLL). See table to the right.
3. In loads where there is vibration, lock nuts (jam nuts) should be used to prevent the connection from turning or loosening. 
4. The jaw ends come with different hardware depending on their size. Jaws from 1/4" through 5/8" have a hex head bolt and nut. Jaws from 3/4" through 1 1/2" have cotter key and bolt.

LOCK NUT

### Working Load Limits (lb and kg) of Turnbuckles

Turnbuckle Size in.	Carbon Eye & Eye Jaw & Eye Jaw & Jaw		Carbon Hook & Hook & Hook & Eye	
	lb	kg	lb	kg
1/4 x 4	500	227	400	182
5/16 x 4 1/2	800	363	700	318
3/8 x 6	1200	545	1000	454
1/2 x 6, 9, 12	2200	999	1500	681
5/8 x 6, 9, 12, 18	3500	1589	2300	1044
3/4 x 6, 9, 12, 18, 24	5200	2361	3000	1362
7/8 x 12, 18	7200	3269	3600	1634
1 x 6, 12, 18, 24	10000	4540	4200	1907
1 1/4 x 12, 18, 24	15200	6901	5000	2270

### WARNING

- Failure to follow the Instructions For Use below and these warnings may cause death or serious injury.
- Use turnbuckles only as indicated.
- Turnbuckles must always be inspected for wear, distortion, cracks and damage before use. If worn, distorted or damaged, discard and replace.
- Turnbuckles are not designed for angular loading, so the loading must be applied in a straight line.



## Jaw & Jaw Turnbuckles, C-788-G



- Drop-Forged Carbon Steel
- Galvanized to Meet ASTM A-153 Specifications
- 5 to 1 Design Factor
- Meets Design Requirements of ASTM F1145, Type 1, Grade 1, Class G
- Jaws on Sizes 1/4" Through 5/8" Have Hex Head Bolt and Nut
- Jaws on Sizes 3/4" Through 1-1/2" Have Cotter Key and Bolt
- IMPORTANT: Instructions For Use
- Turnbuckles are Designed for a Static Load
- In Loads Where There is Vibration, Lock Nuts (Jam Nuts) Should be Used to Prevent the Connection from Turning or Loosening
- DO NOT EXCEED THE WORKING LOAD LIMIT

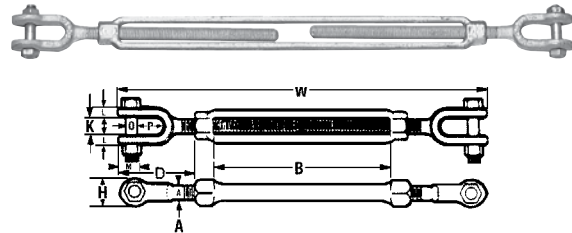

Catalog No.	UPC No. 020418	Finish	Working Load Limit	Thread Diameter (A)	Take Up (B)	Closed Position Length (W)	Weight Each
6250501	087646	Hot Galvanized	500 lb	1/4 in	4 in	7-15/16 in	0.35 lb
6250502	087653	Hot Galvanized	800 lb	5/16 in	4-1/2 in	9-5/16 in	0.51 lb
6250503	087660	Hot Galvanized	1200 lb	3/8 in	6 in	11-3/16 in	0.94 lb
6250505	087677	Hot Galvanized	2200 lb	1/2 in	6 in	12-3/4 in	1.70 lb
6250506	087684	Hot Galvanized	2200 lb	1/2 in	9 in	15-3/4 in	2.15 lb
6250507	087691	Hot Galvanized	2200 lb	1/2 in	12 in	18-3/4 in	2.65 lb
6250510	087714	Hot Galvanized	3500 lb	5/8 in	9 in	17-3/4 in	3.49 lb
6250511	087721	Hot Galvanized	3500 lb	5/8 in	12 in	20-3/4 in	4.00 lb
6250513	087745	Hot Galvanized	5200 lb	3/4 in	6 in	15-3/4 in	4.43 lb
6250514	087752	Hot Galvanized	5200 lb	3/4 in	9 in	18-3/4 in	5.18 lb
6250515	087769	Hot Galvanized	5200 lb	3/4 in	12 in	21-3/4 in	6.50 lb
6250516	087776	Hot Galvanized	5200 lb	3/4 in	18 in	27-3/4 in	7.60 lb
6250519	087790	Hot Galvanized	7200 lb	7/8 in	12 in	23-3/8 in	9.00 lb
6250520	087806	Hot Galvanized	7200 lb	7/8 in	18 in	29-3/8 in	12.08 lb
6250521	087813	Hot Galvanized	10000 lb	1 in	6 in	19-7/16 in	9.47 lb
6250522	087820	Hot Galvanized	10000 lb	1 in	12 in	25-7/16 in	12.90 lb
6250523	087837	Hot Galvanized	10000 lb	1 in	18 in	31-7/16 in	16.00 lb
6250524	087844	Hot Galvanized	10000 lb	1 in	24 in	37-7/16 in	17.85 lb
6250527	087851	Hot Galvanized	15200 lb	1-1/4 in	12 in	27-1/2 in	22.00 lb
6250528	087868	Hot Galvanized	15200 lb	1-1/4 in	18 in	33-1/2 in	25.60 lb
6250529	087875	Hot Galvanized	15200 lb	1-1/4 in	24 in	39-1/2 in	30.00 lb
6250533	087899	Hot Galvanized	21400 lb	1-1/2 in	18 in	37-1/4 in	40.70 lb
6250534	163890	Hot Galvanized	21400 lb	1-1/2 in	24 in	43-1/4 in	41.00 lb

*Continued on next page*

Catalog No.	D Dim.	H Dim.	K Dim.	L Dim.	M Dim.	P Dim.	Q Dim.
6250501	1-19/32 in	5/8 in	13/32 in	3/16 in	15/32 in	3/4 in	1/4 in
6250502	1-15/16 in	11/16 in	1/2 in	3/16 in	1/2 in	3/4 in	1/4 in
6250503	2-1/32 in	7/8 in	1/2 in	1/4 in	9/16 in	13/16 in	5/16 in
6250505	2-5/8 in	1-3/16 in	5/8 in	5/16 in	3/4 in	1-1/16 in	3/8 in
6250506	2-5/8 in	1-3/16 in	5/8 in	5/16 in	3/4 in	1-1/16 in	3/8 in
6250507	2-5/8 in	1-3/16 in	5/8 in	5/16 in	3/4 in	1-1/16 in	3/8 in
6250510	3-3/8 in	1-3/8 in	3/4 in	7/16 in	15/16 in	1-3/8 in	1/2 in
6250511	3-3/8 in	1-3/8 in	3/4 in	7/16 in	15/16 in	1-3/8 in	1/2 in
6250513	3-3/4 in	1-13/16 in	15/16 in	15/32 in	1-3/16 in	1-1/2 in	5/8 in
6250514	3-3/4 in	1-13/16 in	15/16 in	15/32 in	1-3/16 in	1-1/2 in	5/8 in
6250515	3-3/4 in	1-13/16 in	15/16 in	15/32 in	1-3/16 in	1-1/2 in	5/8 in
6250516	3-3/4 in	1-13/16 in	15/16 in	15/32 in	1-3/16 in	1-1/2 in	5/8 in
6250519	4-3/8 in	2 in	1-1/8 in	19/32 in	1-3/8 in	1-3/4 in	3/4 in
6250520	4-3/8 in	2 in	1-1/8 in	19/32 in	1-3/8 in	1-3/4 in	3/4 in
6250521	5-7/32 in	2-3/16 in	1-3/16 in	3/4 in	1-9/16 in	2-1/16 in	7/8 in
6250522	5-7/32 in	2-3/16 in	1-3/16 in	3/4 in	1-9/16 in	2-1/16 in	7/8 in
6250523	5-7/32 in	2-3/16 in	1-3/16 in	3/4 in	1-9/16 in	2-1/16 in	7/8 in
6250524	5-7/32 in	2-3/16 in	1-3/16 in	3/4 in	1-9/16 in	2-1/16 in	7/8 in
6250527	6-1/16 in	2-7/8 in	1-3/4 in	7/8 in	2 in	2-7/16 in	1-1/8 in
6250528	6-1/16 in	2-7/8 in	1-3/4 in	7/8 in	2 in	2-7/16 in	1-1/8 in
6250529	6-1/16 in	2-7/8 in	1-3/4 in	7/8 in	2 in	2-7/16 in	1-1/8 in
6250533	8-1/2 in	3-1/4 in	2-1/16 in	1-3/32 in	2-5/16 in	2-13/16 in	1-3/8 in
6250534	8-1/2 in	3-1/4 in	2-1/16 in	1-3/32 in	2-5/16 in	2-13/16 in	1-3/8 in

## Jaw & Eye Turnbuckles, C-786-G



- Drop-Forged Carbon Steel
- Galvanized to Meet ASTM A-153 Specifications
- 5 to 1 Design Factor
- See Figure C-780-G for Eye Dimensions
- See Figure C-788-G for Jaw Dimensions
- Jaws on Sizes 1/4" Through 5/8" Have Hex Head Bolt and Nut; Jaws on Sizes 3/4" Through 1-1/2" Have Cotter Key and Bolt
- IMPORTANT: Instructions For Use
- Turnbuckles are Designed for a Static Load
- In Loads Where There is Vibration, Lock Nuts (Jam Nuts) Should be Used to Prevent the Connection from Turning or Loosening
- DO NOT EXCEED THE WORKING LOAD LIMIT

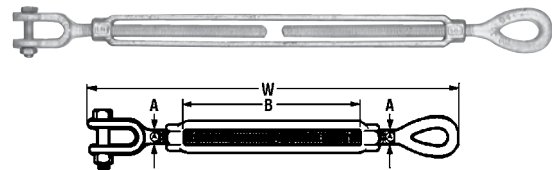

Catalog No.	UPC No. 020418	Finish	Working Load Limit	Thread Diameter (A)	Take Up (B)	Closed Position Length (W)	Weight Each
6250403	087400	Hot Galvanized	1200 lb	3/8 in	6 in	11-9/16 in	0.90 lb
6250405	087417	Hot Galvanized	2200 lb	1/2 in	6 in	13-1/8 in	1.64 lb
6250406	087424	Hot Galvanized	2200 lb	1/2 in	9 in	16-1/8 in	2.08 lb
6250407	087431	Hot Galvanized	2200 lb	1/2 in	12 in	19-1/8 in	2.57 lb
6250409	087448	Hot Galvanized	3500 lb	5/8 in	6 in	14-7/8 in	2.65 lb
6250427	087592	Hot Galvanized	15200 lb	1-1/4 in	12 in	28-9/16 in	19.80 lb



## Hook & Eye Turnbuckles, C-778-G

- Drop-Forged Carbon Steel
- Galvanized to Meet ASTM A-153 Specifications
- 5 to 1 Design Factor
- Meets Design Requirements of ASTM F1145, Type 1, Grade 1, Class F
- IMPORTANT: Instructions For Use
- Turnbuckles are Designed for a Static Load
- In Loads Where There is Vibration, Lock Nuts (Jam Nuts) Should be Used to Prevent the Connection from Turning or Loosening
- DO NOT EXCEED THE WORKING LOAD LIMIT

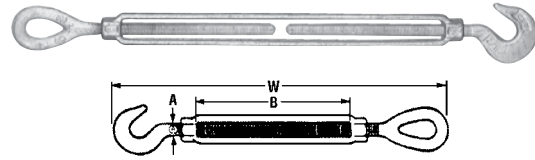

Catalog No.	UPC No. 020418	Finish	Working Load Limit	Thread Diameter (A)	Take Up (B)	Closed Position Length (W)	Weight Each
6250101	086564	Hot Galvanized	400 lb	1/4 in	4 in	7-13/16 in	0.29 lb
6250103	086588	Hot Galvanized	1000 lb	3/8 in	6 in	11-5/8 in	0.80 lb
6250105	086595	Hot Galvanized	1500 lb	1/2 in	6 in	13-1/8 in	1.56 lb
6250106	086601	Hot Galvanized	1500 lb	1/2 in	9 in	16-1/8 in	1.98 lb
6250107	086618	Hot Galvanized	1500 lb	1/2 in	12 in	19-1/8 in	2.46 lb
6250111	086649	Hot Galvanized	2300 lb	5/8 in	12 in	20-9/16 in	3.50 lb

FITTINGS

## Eye & Eye Turnbuckles, C-780-G

- Drop-Forged Carbon Steel
- Galvanized to Meet ASTM A-153 Specifications
- 5 to 1 Design Factor
- Meets Design Requirements of ASTM F1145, Type 1, Grade 1, Class D
- IMPORTANT: Instructions For Use
- Turnbuckles are Designed for a Static Load
- In Loads Where There is Vibration, Lock Nuts (Jam Nuts) Should be Used to Prevent the Connection from Turning or Loosening
- DO NOT EXCEED THE WORKING LOAD LIMIT

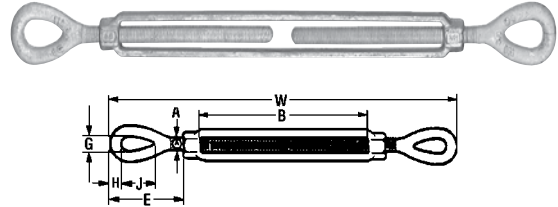

Catalog No.	UPC No. 020418	Finish	Working Load Limit	Thread Diameter (A)	Take Up (B)	Closed Position Length (W)	E Dim.	G Dim.	H Dim.	J Dim.	Weight Each
6250302	087059	Hot Galvanized	800 lb	5/16 in	4-1/2 in	9-7/16 in	2 in	15/32 in	9/32 in	15/16 in	0.45 lb
6250303	087066	Hot Galvanized	1200 lb	3/8 in	6 in	11-13/16 in	2-11/32 in	9/16 in	11/32 in	1-1/8 in	0.84 lb
6250305	087073	Hot Galvanized	2200 lb	1/2 in	6 in	13-7/16 in	2-31/32 in	3/4 in	7/16 in	1-7/16 in	1.50 lb
6250306	087080	Hot Galvanized	2200 lb	1/2 in	9 in	16-7/16 in	2-31/32 in	3/4 in	7/16 in	1-7/16 in	1.98 lb
6250307	087097	Hot Galvanized	2200 lb	1/2 in	12 in	19-7/16 in	2-31/32 in	3/4 in	7/16 in	1-7/16 in	2.46 lb
6250309	087103	Hot Galvanized	3500 lb	5/8 in	6 in	14-7/8 in	3-1/2 in	29/32 in	1/2 in	1-3/4 in	2.56 lb
6250313	087141	Hot Galvanized	5200 lb	3/4 in	6 in	16-3/4 in	4-1/4 in	1-1/32 in	5/8 in	2-1/8 in	3.80 lb
6250315	087165	Hot Galvanized	5200 lb	3/4 in	12 in	22-3/4 in	4-1/4 in	1-1/32 in	5/8 in	2-1/8 in	5.74 lb
6250324	087240	Hot Galvanized	10000 lb	1 in	24 in	38-1/2 in	5-3/4 in	1-15/32 in	7/8 in	3 in	16.00 lb
6250328	087264	Hot Galvanized	15200 lb	1-1/4 in	18 in	35-3/8 in	7 in	1-27/32 in	1-1/8 in	3-9/16 in	23.22 lb

## Connecting Links

Campbell carbon and alloy steel connecting links are all drop-forged and heat treated. Galvanizing is to ASTM A-153 specification. Connecting links are used to connect two pieces of chain or to connect a fitting to a chain.



**REGULAR  
CONNECTING LINK**

**Regular C-752-S, C-752-G, A-752-S**



**PEAR SHAPED  
CONNECTING LINK**

**Pear Shape C-753-G**

**READ AND UNDERSTAND THESE WARNINGS AND INSTRUCTIONS BEFORE USING CONNECTED LINKS.**

### IMPORTANT: Instructions For Use

1. Make sure the connecting link used is the same size as the components being joined, e.g., a 3/8 in. connecting link is used with 3/8 in. chain.
2. To effectively close the connecting link,peen the prongs (using a ball peen hammer) to fill the hole of the mating half as much as possible.
3. Any assembly made using connecting links should be rated at the working load limit (WLL) of the weakest component.
4. Do not exceed WLL. See table right.
5. The WLL of connecting links is based on a straight line pull. Any side or shock loading will significantly reduce the actual WLL.

Working Load Limits (lbs and kg) - Connecting Links							
Size		Regular				Pear Shaped Carbon Steel WLL	
		Carbon Steel WLL		Alloy WLL		lb	kg
in.	mm	lb	kg	lb	kg	lb	kg
1/4	6	1400	636	*		*	
5/16	8	2000	908	*		*	
3/8	10	2800	1271	*		1850	840
1/2	13	4750	2157	7000	3178	3300	1498
5/8	16	7250	3292	10800	4903	5000	2270
3/4	19	10250	4654	15000	6810	7100	3223
7/8	22	*		*		9600	4358

*\*Item not manufactured.*

### WARNING

- Failure to follow the Instructions For Use below and these warnings may cause death or serious injury.
- Use connecting links only as indicated.
- Do not use connecting links for overhead lifting.
- Never re-use connecting links.
- Connecting links must always be inspected for wear, distortion and tightness before use. If worn, distorted or damaged, discard and replace.



## Regular Connecting Links, C-752-S, C-752-G, A-752-S

- Drop-Forged Heat-Treated Carbon or Alloy Steel
- Standard Finish is Self-Colored or Galvanized to Meet ASTM A-153 Specifications
- 4 to 1 Design Factor
- For Proper Closure, Peen the Prongs to Fill the Hole of the Mating Half as Much as Possible
- Meets Design Requirements of Federal Specification RR-C-271D, Type II
- Make Sure the Connecting Link Used is the Same Size as the Components Being Joined. e.g., a 3/8 in. Connecting Link is Used with 3/8 in. Chain
- Any Assembly Made Using Connecting Links Should be Rated at the Working Load Limit of the Weakest Component.
- The Working Load Limit of Connecting Links is Based on a Straight Line Pull. Any Side or Shock Loading Will Significantly Reduce the Actual Working Load Limit.
- NEVER Re-Use a Connecting Link
- DO NOT EXCEED THE WORKING LOAD LIMIT

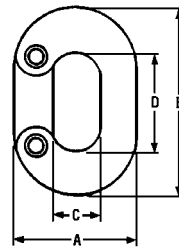

Trade Size	Catalog No.	UPC No. 020418	Material	Finish	Working Load Limit	A Dim.	B Dim.	C Dim.	D Dim.	Weight Each	Shelf Pack
1/4 in	5200404	074677	Carbon Steel	Self-Colored	1400 lb	1 in	1-1/2 in	7/16 in	7/8 in	0.06 lb	10
1/4 in	5200434	074684	Carbon Steel	Galvanized	1400 lb	1 in	1-1/2 in	7/16 in	7/8 in	0.06 lb	10
5/16 in	5200504	074691	Carbon Steel	Self-Colored	2000 lb	1-3/16 in	1-3/4 in	1/2 in	1 in	0.12 lb	10
5/16 in	5200534	074707	Carbon Steel	Galvanized	2000 lb	1-3/16 in	1-3/4 in	1/2 in	1 in	0.11 lb	10
3/8 in	5200604	074714	Carbon Steel	Self-Colored	2800 lb	1-3/8 in	2-1/8 in	9/16 in	1-1/8 in	0.18 lb	10
3/8 in	5200634	074721	Carbon Steel	Galvanized	2800 lb	1-3/8 in	2-1/8 in	9/16 in	1-1/8 in	0.18 lb	10
1/2 in	5200804	074752	Carbon Steel	Self-Colored	4750 lb	1-23/32 in	2-11/16 in	21/32 in	1-7/16 in	0.39 lb	10
1/2 in	5200834	074769	Carbon Steel	Galvanized	4750 lb	1-23/32 in	2-11/16 in	21/32 in	1-7/16 in	0.39 lb	10
1/2 in	5208805	075032	Alloy Steel	Self-Colored	7000 lb	1-23/32 in	2-11/16 in	21/32 in	1-7/16 in	0.39 lb	10
5/8 in	5201004	074790	Carbon Steel	Self-Colored	7250 lb	2-1/8 in	3-3/8 in	13/16 in	1-7/8 in	0.75 lb	10
5/8 in	5201034	074806	Carbon Steel	Galvanized	7250 lb	2-1/8 in	3-3/8 in	13/16 in	1-7/8 in	0.75 lb	10
5/8 in	5209005	075049	Alloy Steel	Self-Colored	10800 lb	2-1/8 in	3-3/8 in	13/16 in	1-7/8 in	0.75 lb	10
3/4 in	5201234	074820	Carbon Steel	Galvanized	10250 lb	2-1/2 in	3-7/8 in	31/32 in	2-1/8 in	1.16 lb	5
3/4 in	5209205	075056	Alloy Steel	Self-Colored	15000 lb	2-1/2 in	3-7/8 in	31/32 in	2-1/8 in	1.16 lb	5



## Pear Shaped Connecting links, C-753-G

- Drop-Forged Heat-Treated Carbon Steel
- Galvanized to Meet ASTM A-153 Specifications
- 4 to 1 Design Factor
- For Proper Closure, Peen the Prongs to Fill the Hole of the Mating Half as Much as Possible
- Make Sure the Connecting Link Used is the Same Size as the Components Being Joined.
- Any Assembly Made Using Connecting Links Should be Rated at the Working Load Limit of the Weakest Component.
- The Working Load Limit of Connecting Links is Based on a Straight Line Pull. Any Side or Shock Loading Will Significantly Reduce the Actual Working Load Limit.
- NEVER Re-Use a Connecting Link
- DO NOT EXCEED THE WORKING LOAD LIMIT

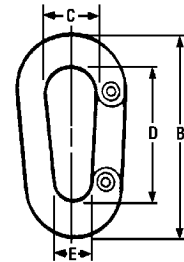
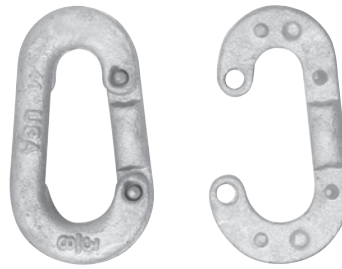

Trade Size	Catalog No.	UPC No. 020418	Working Load Limit	B Dim.	C Dim.	D Dim.	E Dim.	Weight Each
3/8 in	5205634	074912	1850 lb	2-15/16 in	13/16 in	2 in	9/16 in	0.29 lb
1/2 in	5205834	074936	3300 lb	3-5/8 in	1 in	2-1/2 in	11/16 in	0.52 lb
5/8 in	5206035	074950	5000 lb	4-1/4 in	1-1/8 in	2-3/4 in	13/16 in	0.91 lb
3/4 in	5206235	074974	7100 lb	4-7/8 in	1-1/4 in	3-1/8 in	1 in	1.30 lb
7/8 in	5206435	074998	9600 lb	5-11/16 in	1-1/2 in	3-11/16 in	1-1/4 in	2.20 lb



**BLOCKS**

Manila Rope Blocks ..... 120

Wire Rope Blocks..... 124

Sheaves ..... 125

Lineman's Block ..... 126

Utility Block..... 126

Net Block ..... 127

Come Along Hook ..... 127



## Campbell® Blocks

Begun as a forging company in 1834, Campbell/Brewer-Titchener first manufactured horse harnesses, then carriage hardware, then horseless carriage hardware. From hardware for power lines in the 1930's, to forgings for the war effort in the 40's. Campbell/Brewer-Titchener began making high quality, wire rope and chain fittings in the 50's. Today the line includes well over 1000 different types and sizes of drop-forged eyebolts, wire rope clips, shackles, swivels, hooks, turnbuckles and more.

Since 1973, when Campbell/Brewer-Titchener acquired the Boston & Lockport Corporation, the brand has also been a leading name in high quality tackle blocks. This line includes blocks with wood, metal and nylon shells for fiber, manila or wire rope. Many options are offered: a wide selection of drop forged hooks, eyes and shackles; and various bushing types. Replacement sheaves are also available.

## Definitions: Important Block Terms

**Bight:** The area formed by the angle of the incoming and outgoing line (see figure #2, page 133).

**Fairleading:** To change the direction of pull on a lead rope.

**Line Pull:** The line pull is the amount of force transmitted to the rope by the winch, or other forms of power. All Working Load Limits are based on "resultant loads."

**Mechanical Advantage:** The amount by which a block system multiplies the force (or load) applied to it.

**Parts of Line:** The number of lines needed for a given load.

### LOADS

**Ton:** Ton is equal to 2240 LB (Long Ton) unless otherwise noted.

**Proof Test:** Campbell® has the ability to proof test all blocks and fittings. The usual proof test is twice the Working Load Limit. Proof testing and certifications can be performed at customer's request, for a nominal charge.

**Side Load:** The result of a load which is applied off-center.

**Shock Load:** The result of the rapid application of force (such as impacting and /or jerking), or the rapid movement of a static load.

**Ultimate Load:** The average load at which a product fails, or no longer supports the load.

**Working Load Limit:** The Working Load Limit (WLL) is the maximum resultant load which should ever be applied to the product in service, even when new, and when the load is uniformly applied in direct tension.

Caution should be used when determining the resultant load, as the manner in which the product is used can increase the load. (Refer to Figure 1, page 133)



## Warning Statement - Blocks

### BLOCK USE AND MAINTENANCE INFORMATION:

Read, understand and follow these warnings and instructions prior to selection, maintenance and use of tackle block systems.

#### WARNING



#### Falling load may cause death or serious injury

- Do Not exceed "Working Load Limit"
- Do Not stand under load or in bight
- Do Not side load or shock load
- Do Not use worn or damaged block or rope

**IMPORTANT: Read and understand the instructions and warnings before using this block. It is the responsibility of the employer to place this information into the hands of the operator.**

### INSTRUCTIONS FOR USE

- Do Not exceed the "Working Load Limit" of the block(s) being used. Check the label on the block or refer to the Apex Tool Group catalog
- Do Not exceed the "Working Load Limit" or operating limitations of the rope being used. If uncertain, consult the rope manufacturer
- Use the recommended rope diameter. See the label or Apex Tool Group catalog
- Know the weight of the load to be lifted and the conditions of the lift. For example, a flat load embedded in mud will require extra pulling power to break the vacuum and may create a shock load
- Be sure there are no impediments in the way of the lift that could snag the load and increase the load on the block(s)
- Blocks used above or aloft should be attached with shackles
- Do Not side load or shock load blocks. When using snatch blocks, be sure that the block is closed properly before the load is applied
- Snatch blocks should not be used for hoisting: they should be used for fairleading only
- Do Not stand under the load or in the bight area. Do Not stand in the direct line of pull of any load
- Be sure the structural member to which the block is being attached is strong enough to support the load
- Assure proper lubrication of the block. Improper lubrication can lead to block failure. Read and follow lubrication schedules.

#### ADVERTENCIA

Para prevenir la posibilidad de una lesión personal seria:

- **NO EXCEDA** los límites de carga de las cadenas o componentes.
- **NO LA UTILICE** para cargar hacia arriba o para izar.
- **NO LA UTILICE** si la cadena o los componentes están visualmente distorsionados o gastados.

#### WARNING

To prevent the possibility of serious bodily injury:

- **DO NOT EXCEED** the working load limits for chain or components.
- **DO NOT USE** for overhead lifting or hoisting.
- **DO NOT USE** if the chain or components are visibly distorted or worn.

## Important Information

Block systems must be properly designed, used and maintained. A continual inspection program should be undertaken to discover gouges, distortion, cracks, elongation (or stretching), spread in the throat openings of hooks, severe wear or other damage. Any abuse, misuse or alteration may lessen the load a block system will sustain. Some examples of changes are as follows:

- Twisting or side loading
- Disfigurement
- Corrosion
- Shock loading
- Use for a purpose other than that for which a particular block was intended
- Use to carry a load in excess of the Working Load Limit

Blocks consist of one or more sheaves fitted in a wood or metal shell. Blocks are supported by a fitting attached to the strap of the block. These blocks are intended to be used in conjunction with other components in a load-sustaining system to gain mechanical advantage. Care should be taken to select components of compatible type, size and Working Load Limit.

Work Load Limits shown in Apex Tool Group literature are applicable to new blocks, or blocks in “as new” condition.

## Selection of Blocks

To select a block to fit your requirements, the following must be considered:

1. Are there regulations that could affect the choice of blocks, such as federal, OSHA, state, maritime, etc.
2. What loads (weight) will be lifted? This must be known to select a block with an appropriate work load limit.
3. How many parts of line are required? (See “Method of Figuring,” page 135.)
4. What is the size, type and working load limit of rope to be used? Consult a rope catalog to determine working load, rope strength and fatigue factors.
5. What is the speed of the line? This will help determine what type of bearing should be used.
6. Insure that the proper type of fitting is utilized. A block used above or aloft should be attached with shackles.
7. How will the block be reeved, and does it require a dead end becket? (See “Method of Reeving Manila and Wire Rope Blocks,” page 135.)
8. What is the fleet angle of the wire line? Line entrance and exit angles should be no more than 90°. Use the bight angle factor (See page 134) to determine resultant load to properly determine Working Load Limit of your block.

## Block Inspection and Maintenance

- Carefully examine the block(s) and rope(s) for wear and damage before each use
- Do not use a block if the sheaves do not turn freely. Sheaves must turn freely. Tight sheaves could indicate worn bushings or bearings
- Do not use a block with excessive play in the sheave. Check for excessive play in the sheave. Excessive play could indicate worn bushings or bearings
- Do not use a block with a loose becket bolt or rope splice. Check the becket bolt holding the dead end of the rope; the becket bolt should be tight. The rope splice on the becket should also be tight
- Do not use a block with worn or frayed rope. Check the condition of the rope for fraying
- Do not use a block with a damaged hook latch. Hooks on blocks should have a latch in proper operating condition. If the latch does not engage the tip of the hook, the hook could be sprung or opened due to an overload on a previous lift



## Lubrication

The following represents the minimum recommended schedule for lubrication using medium viscosity lithium-based grease. Your own usage, including environmental factors and the frequency and type of use, may require lubrication that is more frequent.

### SHEAVE BEARINGS

**Tapered Rollers:** Every 40 hours of continuous operation or every 30 days of intermittent operation.

**Roller Type:** Every 24 hours of continuous operation or every 14 hours of intermittent operation.

**Bronze (Not self-lubricated):** Every 8 hours of continuous operation or every 14 days of intermittent operation.

### HOOK BEARINGS

**Anti-Friction:** Every 14 days for frequent swiveling or every 45 days for infrequent swiveling.

**Bronze Thrust/No Bearings:** Every 16 hours for frequent swiveling or every 21 days for infrequent swiveling.

## Sheave, Bushing and Bearing Information

**Anti-friction Bearings (tapered, needle and ball bearings)** are for faster line speeds and more frequent use at greater loads (minimum bearing friction).

**Iron Bushings (common bore)** are very low speed lines and very infrequent use (high bearing friction).

**Bronze Bushings (self lubricating bronze, graphite bronze and pressure lubrication bronze)** are for slow line speeds.

**Self-lubricating bronze and graphite bronze bushings** are for infrequent use (moderate bearing friction).

**Pressure lubrication bronze bushings** are for frequent use at greater loads (moderate bearing friction).

The performance of bronze bushings is best determined by the "PV Factor" (maximum pressure velocity) at which the bearing is operating. This is the relationship between bearing pressure and bearing surface velocity. Brewer-Titchener™ bronze bushings have the following material properties:

Maximum Bearing Pressure (BP): 4,500 pounds per square inch  
 Maximum Bearing Velocity (BV): 1,200 feet per minute  
 Maximum Pressure Velocity Factor (PV): 55,000  
 (Due to material property relations, the maximum BP times the maximum BV is not equal to the maximum

To calculate Bearing Pressure (BP):  $\frac{\text{Line Pull} \times \text{Bight Angle Factor}}{\text{Shaft Diameter} \times \text{Hub Width}}$

To calculate Bearing Velocity (BV):  $\text{PV} \times \text{BP}$

To calculate Line Speed:  $\frac{\text{BV} (\text{Tread Diameter} + \text{Rope Diameter})}{\text{Shaft Diameter}}$

These formulas can be used to determine the maximum allowable line speed for a given total sheave load. The maximum allowable line speed should be equal to or exceeding the required line speed. If the required line speed is greater than the calculated maximum allowable line speed, increase the shaft diameter and/or the hub width. For example: Using a 12" diameter sheave (tread diameter = 10.25"; wire diameter = 0.75"; shaft diameter = 1.50"; hub width = 1.62"), a 5,000 lb. line pull and a 90° bight angle determine the allowable line speed.

$$\text{BP} = \frac{(5,000 \text{ lb.}) \times (1.41^*)}{(1.50" \times 1.62")} = 2,901 \text{ psi}$$

(line pull) (bight angle factor)/(shaft dia.) (hub width)

$$\text{BV} = \frac{(55,000 \text{ psi.})}{2,901} = 19 \text{ FPM Allowable}$$

(PV factor) (BP)

$$\text{Line Speed} = \frac{19 \times (10.25" + 0.75")}{1.50"} = 139 \text{ FPM Allowable}$$

(BV) (tread dia. + rope dia.) (shaft dia.)

# Load on Blocks

**⚠ WARNING**

The Working Load Limit (WLL) is the maximum resultant load which should ever be applied to a block and its fittings. Blocks used to fairlead (single sheave and snatch blocks) can be subjected to a load greater than the weight being lifted or pulled.

## Results of Applied Loads on Single Blocks

Figure No. 1



**⚠ WARNING**

The total weight (load) on a single sheave block or snatch block varies with the bight angle between the incoming and outgoing line to the block (see Figure 2).

BLOCKS

Figure No. 2

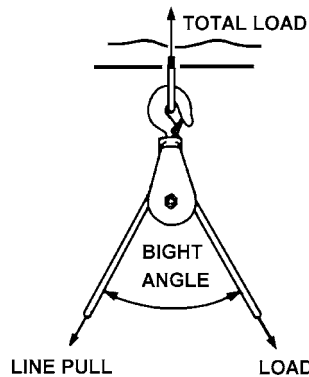



## Load on Blocks (continued)

To determine this load:

1. Determine the bight angle of the line.
2. Refer to Table 1 for the corresponding angle factor.
3. Multiply the pull on the line or the weight of the load (line pull) by the angle factor to obtain the load on the block.

## Bight Angle Factor

**Table 1**

Angle	Factor	Angle	Factor
0°	2.00	100°	1.29
10°	1.99	110°	1.15
20°	1.97	120°	1.00
30°	1.93	130°	0.84
40°	1.87	135°	0.76
45°	1.84	140°	0.68
50°	1.81	150°	0.52
60°	1.73	160°	0.35
70°	1.64	170°	0.17
80°	1.53	180°	0.00
90°	1.41	—	—

**Figure No. 3**

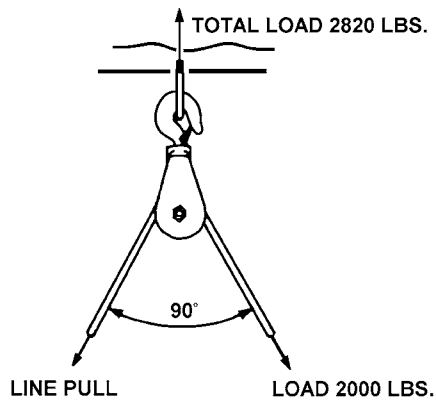

## Method of Reeving Manila and Wire Rope Blocks

The method of reeving tackle blocks will vary with the applications. With heavy lift cargo booms, cranes and so forth, where blocks with four sheaves or more are required, a number of lead blocks have to be considered. The Campbell engineering department will be happy to assist on such applications.

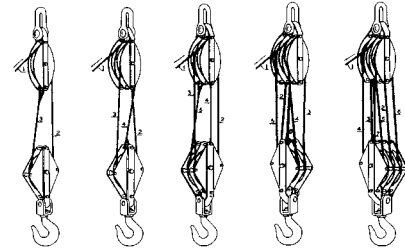

The methods of reeving tackle blocks will vary with the applications.

## Method of Figuring “Parts of Line”

$$\frac{L}{P} = E$$

L = Load lifted in pounds  
P = Line pull in pounds  
E = Efficiency factor

For example: To figure “Parts of Line” required when load lifted “L” and line pull “P” are known.

Parts of Line =	1	2	3	4	5	6	7	8	9	10	11	12
Bronze Bushed	0.96	1.85	2.8	3.6	4.4	5.2	5.9	6.6	7.3	7.9	8.5	9.1
“E” Factors												
Roller Bearing	0.98	1.9	2.9	3.8	4.7	5.6	6.5	7.3	8.2	9.0	9.8	10.6

$$\frac{32,000 \text{ lb. (Load lifted "L")}}{6,000 \text{ lb. (Line pull "P")}} = 5.3 \text{ ("E")}$$

You can see in the table on the left that an “E” factor of 5.3 requires 6 “Parts of Line”.

## Testing of Blocks and Fittings for Commercial Marine Cargo Vessels

The Campbell plant has the facilities to proof test and certify blocks and fittings to meet the safety standards established by most maritime nations. Following are the proof tests required for maritime certification.

1. Shackles, hooks, links and swivels; proof tested to twice the working load limit.
2. Multiple-sheave blocks up to 20-ton (18, 144-Kgs.) working load limit; proof tested to twice the working load limit.
3. Multiple-sheave blocks with working load limits of 20-40 ton (18,144-36,288 Kgs.): proof tested to 20 ton (18, 144 Kgs.) in excess of the working load limit.
4. Multiple-sheave blocks with working load limits over 40 ton (36,288 Kgs.): proof tested to 1.5 times the working load limit.
5. Single blocks proof tested to 4 times the line pull.
6. Cargo hoisters (6001 Series): proof tested to 4 times the line pull shown in the catalog. All other single blocks proof-tested to twice the work load shown in the catalog, and marked with a working load one half that shown in the catalog. All blocks and fittings certified to maritime standards will be indelibly marked with working load, proof test and identifying number. All tests will be in long ton equal to 2,240 pounds (1,016 Kgs.)

**NOTICE:** The product specifications and dimensions are as accurate as possible at the time of printing. However, because we are constantly improving the quality and design of our products, they can change without notice.





## Regular Wood Shell Blocks for Manila Rope

- Hard Wood Shells
- Model 3001 Single Sheave, Model 3002 Double Sheave, Model 3003 Triple Sheave
- Drop Forged Fittings
- Bronze Self-Lubricating Bushings
- Galvanized Metal Parts
- Working Loads are Resultant Working Loads
- DO NOT EXCEED THE WORKING LOAD LIMIT



Catalog No.	UPC No. 020418	Block Size	Sheaves	Fitting Type	Rope Diameter	Sheave Size - OD	Sheave Size - Rim Thickness	Sheave Size - Center Pin Diameter	Working Load Limit	Weight Each
7205336	165894	3 in	Single	Round Loose Hook "AF"	3/8 in	1-3/4 in	1/2 in	3/8 in	500 lb	1.00 lb
7206836	165948	3 in	Double	Round Loose Hook "AF"	3/8 in	1-3/4 in	1/2 in	3/8 in	800 lb	1.50 lb
7205436	165900	4 in	Single	Round Loose Hook "AF"	1/2 in	2-1/4 in	5/8 in	3/8 in	1000 lb	1.90 lb
7206936	165955	4 in	Double	Round Loose Hook "AF"	1/2 in	2-1/4 in	5/8 in	3/8 in	1400 lb	3.00 lb
7208536	166006	4 in	Triple	Round Loose Hook "AF"	1/2 in	2-1/4 in	5/8 in	3/8 in	1800 lb	3.58 lb
7205434	104282	4 in	Single	Swivel Hook with Latch "G"	1/2 in	2-1/4 in	5/8 in	3/8 in	1000 lb	2.00 lb
7206934	105210	4 in	Double	Swivel Hook with Latch "G"	1/2 in	2-1/4 in	5/8 in	3/8 in	1400 lb	3.00 lb
7208534	106118	4 in	Triple	Swivel Hook with Latch "G"	1/2 in	2-1/4 in	5/8 in	3/8 in	1800 lb	4.00 lb
7205435	104299	4 in	Single	Screw Pin Anchor Shackle "K"	1/2 in	2-1/4 in	5/8 in	3/8 in	1000 lb	2.00 lb
7206935	105227	4 in	Double	Screw Pin Anchor Shackle "K"	1/2 in	2-1/4 in	5/8 in	3/8 in	1400 lb	3.00 lb
7205536	165917	5 in	Single	Round Loose Hook "AF"	5/8 in	3 in	3/4 in	3/8 in	1200 lb	2.80 lb
7207036	165962	5 in	Double	Round Loose Hook "AF"	5/8 in	3 in	3/4 in	3/8 in	1800 lb	4.20 lb
7208636	166013	5 in	Triple	Round Loose Hook "AF"	5/8 in	3 in	3/4 in	3/8 in	2400 lb	5.50 lb
7205535	104442	5 in	Single	Screw Pin Anchor Shackle "K"	5/8 in	3 in	3/4 in	3/8 in	1200 lb	2.50 lb
7207035	105371	5 in	Double	Screw Pin Anchor Shackle "K"	5/8 in	3 in	3/4 in	3/8 in	1800 lb	4.00 lb
7205636	165924	6 in	Single	Round Loose Hook "AF"	3/4 in	3-1/2 in	1 in	1/2 in	1800 lb	4.00 lb
7207136	165979	6 in	Double	Round Loose Hook "AF"	3/4 in	3-1/2 in	1 in	1/2 in	2500 lb	8.00 lb
7208736	166020	6 in	Triple	Round Loose Hook "AF"	3/4 in	3-1/2 in	1 in	1/2 in	3200 lb	9.00 lb
7205635	104596	6 in	Single	Screw Pin Anchor Shackle "K"	3/4 in	3-1/2 in	1 in	1/2 in	1800 lb	4.00 lb
7207135	105524	6 in	Double	Screw Pin Anchor Shackle "K"	3/4 in	3-1/2 in	1 in	1/2 in	2500 lb	6.50 lb
7205835	104794	8 in	Single	Screw Pin Anchor Shackle "K"	1 in	4-3/4 in	1-1/8	5/8 in	2800 lb	9.50 lb
7207335	105692	8 in	Double	Screw Pin Anchor Shackle "K"	1 in	4-3/4 in	1-1/8	5/8 in	3800 lb	13.00 lb

## Painter's Staging Blocks

- Model 3001J - Single Wood Shell Block with Becket and Long, Loose Hook
- Roller Bushed
- For 3/4" Manila Rope
- Galvanized Metal Parts
- DO NOT EXCEED THE WORKING LOAD LIMIT



Catalog No.	UPC No.	Block Size	Sheaves	Fitting Type	Rope Diameter	Sheave Size - OD	Sheave Size - Rim Thickness	Sheave Size - Center Pin Diameter	Working Load Limit	Weight Each
7209803	106767	6 in	Single	Long Loose Hook "J"	3/4 in	3-1/2 in	1 in	1/2 in	1800 lb	5.00 lb

## B & L Star Metal Blocks for Manila or Fiber Rope

- Model 3041 Single Sheave, Model 3042 Double Sheave, Model 3043 Triple Sheave
- Steel Shells
- Bronze Self-Lubricating Bushings
- Galvanized Finish
- Working Loads are Resultant Working Loads
- DO NOT EXCEED THE WORKING LOAD LIMIT



Catalog No.	UPC No.	Block Size	Sheaves	Fitting Type	Rope Diameter	Sheave Size - OD	Sheave Size - Rim Thickness	Sheave Size - Center Pin Diameter	Working Load Limit	Weight Each
7245335	171734	3 in	Single	Round Loose Hook "AF"	3/8 in	1-3/4 in	1/2 in	3/8 in	700 lb	1.50 lb
7245336	109041	3 in	Single	Screw Pin Anchor Shackles "K"	3/8 in	1-3/4 in	1/2 in	3/8 in	700 lb	1.50 lb
7245435	171765	4 in	Single	Round Loose Hook "AF"	1/2 in	2-1/4 in	5/8 in	3/8 in	1100 lb	2.50 lb
7246935	171901	4 in	Double	Round Loose Hook "AF"	1/2 in	2-1/4 in	5/8 in	3/8 in	1600 lb	3.52 lb
7248535	172045	4 in	Triple	Round Loose Hook "AF"	1/2 in	2-1/4 in	5/8 in	3/8 in	2200 lb	4.50 lb
7245434	109188	4 in	Single	Swivel Hook with Latch "G"	1/2 in	2-1/4 in	5/8 in	3/8 in	1100 lb	2.50 lb
7247135	171963	6 in	Double	Round Loose Hook "AF"	3/4 in	3-1/2 in	1 in	1/2 in	3300 lb	10.58 lb
7247136	110368	6 in	Double	Screw Pin Anchor Shackles "K"	3/4 in	3-1/2 in	1 in	1/2 in	3300 lb	9.50 lb
7245836	109638	8 in	Single	Screw Pin Anchor Shackles "K"	1 in	4-3/4 in	1-3/8 in	5/8 in	3300 lb	11.00 lb
7248936	111402	8 in	Triple	Screw Pin Anchor Shackles "K"	1 in	4-3/4 in	1-3/8 in	5/8 in	7000 lb	23.00 lb



## Gin or Roofer's Block for Manila Rope

- Model 3061V - Furnished with A Drop-Forged, Flat Swivel Hook with Latch
- Roller Bushing
- Blue Painted Finish
- Working Loads are Resultant Working Loads
- Lift Should Not Exceed 500 lbs.
- DO NOT EXCEED THE WORKING LOAD LIMIT



Catalog No.	UPC No.	Block Size	Sheaves	Fitting Type	Rope Diameter	Sheave Size - OD	Sheave Size - Rim Thickness	Sheave Size - Center Pin Diameter	Working Load Limit	Weight Each
7269812	115387	12 in	Single	Swivel Hook with Latch "V"	1 in	12 in	1-3/8 in	5/8 in	1000 lb	13.00 lb

## Drop Link Snatch Blocks for Manila Rope

- Wood or Steel Shells
- Cross-Bolted Shell
- Fittings Drop-Forged; Metal Parts Galvanized
- Bronze Self-Lubricating Bushings
- Drop Link Snatch Blocks Are Primarily Used As Lead Blocks
- Not Recommended for Hoisting
- Working Loads are Resultant Working Loads
- DO NOT EXCEED THE WORKING LOAD LIMIT



Catalog No.	UPC No.	Block Size	Block Type	Sheaves	Fitting Type	Rope Dia.	Sheave Size - OD	Sheave Size - Rim Thickness	Bearing Diameter	Sheave Size - Center Pin Dia.	Working Load Limit	Weight Each
7265486	112881	4 in	Wood,3071	Single	Swivel Hook w/Latch "V"	3/4 in	2 in	7/8 in	5/8 in	3/8 in	750 lb	2.00 lb
7265686	113130	6 in	Wood,3071	Single	Swivel Hook w/Latch "V"	7/8 in	3 in	1-1/8 in	3/4 in	1/2 in	2400 lb	7.20 lb
7265696	113192	6 in	Steel,3073	Single	Swivel Hook w/Latch "V"	7/8 in	3 in	1-1/8 in	3/4 in	1/2 in	2400 lb	7.40 lb
7265886	113420	8 in	Wood,3071	Single	Swivel Hook w/Latch "V"	1 in	4-1/2 in	1-3/8 in	7/8 in	5/8 in	4800 lb	12.50 lb
7265896	113482	8 in	Steel,3073	Single	Swivel Hook w/Latch "V"	1 in	4-1/2 in	1-3/8 in	7/8 in	5/8 in	4800 lb	13.00 lb

## Safety Locking Snatch Blocks for Manila Rope

- Wood or Steel Shells
- Bronze Self-Lubricating Bushings
- Drop Forged Galvanized Fittings
- Working Loads are Resultant Working Loads
- DO NOT EXCEED THE WORKING LOAD LIMIT



Catalog No.	UPC No. 020418	Block Size	Block Type	Sheaves	Fitting Type	Rope Dia.	Sheave Size - OD	Sheave Size - Rim Thickness	Bearing Diameter	Sheave Size - Center Pin Dia.	Working Load Limit	Weight Each
7267186	114250	6 in	Wood,3072	Single	Swivel Hook w/Latch "V"	7/8 in	3 in	1-1/8 in	3/4 in	1/2 in	3000 lb	9.00 lb
7267196	114311	6 in	Steel,3074	Single	Swivel Hook w/Latch "V"	7/8 in	3 in	1-1/8 in	3/4 in	1/2 in	3000 lb	6.00 lb
7267396	114472	8 in	Steel,3074	Single	Swivel Hook w/Latch "V"	1 in	4-1/2 in	1-3/8 in	7/8 in	5/8 in	5000 lb	12.50 lb

## Nylon Blocks for Manila Rope

- Nylon Shells and Sheaves
- Single 3101F, Double 3102F
- Fittings Are Drop-Forged
- Plated Strap and Connections
- Working Loads are Resultant Working Loads
- DO NOT EXCEED THE WORKING LOAD LIMIT



Catalog No.	UPC No. 020418	Block Size	Sheaves	Fitting Type	Rope Diameter	Sheave Size - OD	Sheave Size - Rim Thickness	Bearing Diameter	Sheave Size - Center Pin Diam.	Working Load Limit	Weight Each
7222213	107320	2 in	Double	Flat Eye Loose Hook "F"	3/8 - 1/2 in	2 in	1-1/8 in	5/8 in	3/8 in	1000 lb	1.22 lb
7220214	107276	2 in	Single	Swivel Hook with Latch "G"	3/8 - 1/2 in	2 in	1-1/8 in	5/8 in	3/8 in	500 lb	0.44 lb
7222214	107337	2 in	Double	Swivel Hook with Latch "G"	3/8 - 1/2 in	2 in	1-1/8 in	5/8 in	3/8 in	1000 lb	1.60 lb

## Eastern Snatch Block for Manila Rope

- Model 3075V - Steel Shells
- Bronze Self-Lubricating Bushings
- Drop-Forged Fittings and Galvanized
- Working Loads are Resultant Working Loads
- DO NOT EXCEED THE WORKING LOAD LIMIT



Catalog No.	UPC No. 020418	Block Size	Sheaves	Fitting Type	Rope Dia.	Sheave Size - OD	Sheave Size - Rim Thickness	Bearing Diameter	Sheave Size - Center Pin Dia.	Working Load Limit	Weight Each
7268796	115004	6 in	Single	Swivel Hook w/Latch "V"	7/8 in	3 in	1-1/8 in	3/4 in	1/2 in	3000 lb	7.20 lb



## Team Snatch Block for Wire Rope

- Model 4091V - Steel Shells with Steel Sheaves
- Drop-Forged Fittings
- Bronze, Self-Lubricating Bushings
- Painted Finish
- Working Loads are Resultant Working Loads
- DO NOT EXCEED THE WORKING LOAD LIMIT



Catalog No.	UPC No. 020418	Block Size	Sheaves	Fitting Type	Rope Dia.	Sheave Size - OD	Sheave Size - Rim Thickness	Bearing Diameter	Sheave Size - Center Pin Dia.	Working Load Limit (Metric Tons)	Weight Each
7329919	123221	6 in	Single	Swivel Hook with Latch "V"	5/8 in	6 in	1-1/4 in	1-1/4 in	1 in	7 t	30.32 lb

## Drop Side Snatch Blocks

- Model 4099
- For Wire Rope
- Steel Shells with Steel Sheaves
- Drop-Forged Fittings
- 3" & 4-1/2" Blocks Have Bronze Self-Lubricating Bushings; 6" Have Grooved Bronze Bushings with Pressure Grease Lubrication
- Galvanized Finish
- Special Feature: the Bolt Cannot Be Lost When the Block is Opened
- Connections Are Easily Interchangeable
- Working Loads are Resultant Working Loads
- DO NOT EXCEED THE WORKING LOAD LIMIT



Catalog No.	UPC No. 020418	Block Size	Fitting Type	Wire Rope Diameter	Sheave Size - OD	Sheave Size - Center Pin Diameter	Working Load Limit (Metric Tons)	Weight Each
7339750	124716	3 in	Swivel Hook "H"	3/8 in	3 in	3/4 in	2 t	4.35 lb
7339752	124730	3 in	Swivel Eye w/Screw Pin Shackle "Q"	3/8 in	3 in	3/4 in	2 t	3.00 lb
7339754	124754	3 in	Swivel Hook with Latch "V"	3/8 in	3 in	3/4 in	2 t	4.50 lb
7339755	124761	3 in	No Connection "NC"	3/8 in	3 in	3/4 in	2 t	3.00 lb
7339756	185977	3 in	Drilled Swivel Eye "P"	3/8 in	3 in	3/4 in	2 t	4.50 lb
7339760	124778	4-1/2 in	Swivel Hook "H"	1/2 in	4-1/2 in	1 in	4 t	11.00 lb
7339762	124792	4-1/2 in	Swivel Eye w/Screw Pin Shackle "Q"	1/2 in	4-1/2 in	1 in	4 t	12.00 lb
7339764	124815	4-1/2 in	Swivel Hook with Latch "V"	1/2 in	4-1/2 in	1 in	4 t	12.24 lb
7339765	124822	4-1/2 in	No Connection "NC"	1/2 in	4-1/2 in	1 in	4 t	6.00 lb
7339790	124952	6 in	Swivel Hook "H"	3/4 in	6 in	1-1/2 in	8 t	26.00 lb
7339792	124976	6 in	Swivel Eye w/Screw Pin Shackle "Q"	3/4 in	6 in	1-1/2 in	8 t	27.00 lb
7339794	124990	6 in	Swivel Hook with Latch "V"	3/4 in	6 in	1-1/2 in	8 t	26.00 lb

## Iron & Steel Sheaves for Manila Rope

- Model 4213
- Cast Iron or Steel Sheaves
- Feature Bronze Self-Lubricating Bushings



Catalog No.	UPC No. 020418	Max. Rope Diameter	Outside Diameter	Rim Width	Pin Diameter	Material	Weight Each
7344032	126475	3/8 in	1-3/4 in	1/2 in	3/8 in	Steel	0.26 lb
7344132	126482	1/2 in	2-1/4 in	5/8 in	3/8 in	Steel	0.40 lb
7344232	126505	5/8 in	3 in	3/4 in	3/8 in	Steel	0.63 lb
7344432	126536	3/4 in	3-1/2 in	1 in	1/2 in	Iron	1.06 lb
7344832	126581	1 in	4-3/4 in	1-1/8 in	5/8 in	Iron	2.25 lb

## Extra Heavy Iron & Steel Sheaves for Wire Rope

- Steel or Cast Iron Sheaves
- Feature Iron or Bronze Self-Lubricating (SL) Bushings
- Painted or Galvanized Finish

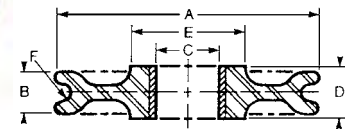

Catalog No.	UPC No. 020418	Max. Rope Diameter	Outside Diameter	Hub Diameter	Hub Width	Rim Width	Finish	Pin Diameter	Material	Bushing Type	Weight Each
7360122	127649	1/4 in	3 in	1-1/8 in	9/16 in	1/2 in	Painted	3/8 in	Steel	Bronze Bushed, SL	0.63 lb
7360222	127656	3/8 in	3 in	1-1/8 in	13/16 in	3/4 in	Painted	3/8 in	Steel	Bronze Bushed, SL	0.75 lb
7360522	127694	3/8 in	4 in	1-1/2 in	13/16 in	3/4 in	Painted	1/2 in	Steel	Bronze Bushed, SL	1.25 lb
7365522	128363	3/8 in	4 in	1-1/2 in	13/16 in	3/4 in	Painted	3/4 in	Steel	Bronze Bushed, SL	1.50 lb
7365622	128370	1/2 in	4 in	2 in	1-1/16 in	1 in	Painted	3/4 in	Steel	Bronze Bushed, SL	2.00 lb
7360922	127755	1/2 in	5 in	2-1/8 in	1-1/16 in	1 in	Painted	3/4 in	Iron	Bronze Bushed, SL	3.00 lb
7361022	127762	3/8 in	6 in	2-1/8 in	13/16 in	3/4 in	Painted	5/8 in	Iron	Bronze Bushed, SL	3.50 lb
7361234	127809	3/8 in	6 in	2-1/4 in	1-1/16 in	1 in	Painted	3/4 in	Iron	Bronze Bushed, SL	4.50 lb
7361432	127854	3/8 in	6 in	2-1/4 in	1-1/16 in	1 in	Painted	1 in	Iron	Bronze Bushed, SL	4.75 lb
7361222	127786	1/2 in	6 in	2-1/8 in	1-1/16 in	1 in	Painted	3/4 in	Iron	Bronze Bushed, SL	3.00 lb
7361224	127793	1/2 in	6 in	2-1/8 in	1-1/16 in	1 in	Galvanized	3/4 in	Iron	Bronze Bushed, SL	3.00 lb
7361422	127847	1/2 in	6 in	2-1/8 in	1-1/16 in	1 in	Painted	1 in	Iron	Bronze Bushed, SL	3.00 lb
7361522	127861	1/2 in	6 in	2-1/4 in	1-1/16 in	1 in	Painted	1-1/4 in	Iron	Bronze Bushed, SL	4.20 lb
7351722	127038	1/2 in	8 in	2-1/8 in	1-1/16 in	1 in	Painted	3/4 in	Iron	Iron Bushing	5.75 lb
7361722	127885	1/2 in	8 in	2-1/8 in	1-1/16 in	1 in	Painted	3/4 in	Iron	Bronze Bushed, SL	5.75 lb
7361733	127892	1/2 in	8 in	2-1/8 in	1-1/16 in	1 in	Galvanized	3/4 in	Iron	Bronze Bushed, SL	7.00 lb

BLOCKS



## Extra Heavy Eastern Pattern Snatch Block

- Model 4102V - Steel Shells with Steel Sheaves
- Drop-Forged Fittings
- Bronze, Self-Lubricating Bushings
- Galvanized Finish
- Features A Steel Sleeve Over A Steel Pin for Increased Strength and Durability
- Combination Score to Handle Variety of Sizes of Wire and Manila Rope
- Working Loads are Resultant Working Loads
- DO NOT EXCEED THE WORKING LOAD LIMIT



Catalog No.	UPC No. 020418	Block Size	Fitting Type	Manila Rope Diameter	Wire Rope Diameter	Sheave Size - OD	Sheave Size - Rim Thickness	Bearing Diameter	Sheave Size - Center Pin Dia.	Working Load Limit (Metric Tons)	Weight Each
7336624	123849	6 in	Swivel Hook w/ Latch "V"	7/8 in	3/8 in	3 in	1-1/8 in	1 in	1/2 in	2 t	10.00 lb

## Lineman's Snatch Block, 5022

- Model 5022
- For Stringing Light Conductor Cable
- Hook Fits Around Insulator Pin or in the Insulator Hole
- Can Be Driven Into A Pole or Cross Arm
- Available with Bronze Self-Lubricating (SL) Bushings or Roller Bushed Bearings
- Available with or Without Hook



Catalog No.	UPC No. 020418	Fitting Type	Rope Size	Finish	Bushing Type	Weight Each
7380601	129834	Hook	3/4 in	Galvanized	Roller Bushed	2.50 lb
7380602	129841	Hook	3/4 in	Galvanized	Bronze Bushed, SL	2.50 lb
7380603	129858	None	3/4 in	Galvanized	Bronze Bushed, SL	2.22 lb

## Hand Line Utility Block, CHB300 / CHB303

- Model CHB300 / CHB303
- For Stringing Conductor Cable or Fiber Rope Applications
- Side Opening Block with Zinc Plated Swivel Hook with Safety Latch
- CHB300 features Ultra-lightweight Block and Sheave Molded From Rugged Reinforced Nylon Fiberglass High Di-Electric Material and 1,000 lb. Safe Working Load Limit
- CHB303 features Lightweight Aluminum Alloy Block and Sheave Construction with Permanently Lubricated Sheave and Safety-tethered Locking Pin and Strongest in Class 1,500 lb. Safe Working Load Limit
- 3" Sheaves - Blocks Can Accommodate Rope Through 5/8" Diameter
- Design Factor: 3 to 1



Catalog No.	UPC No. 020418	Block Size	Fitting Type	Rope Size	Working Load Limit	Weight Each
7380300	225680	3 in	Hook w/Latch	5/8 in	1000 lb	1.90 lb
7380303	274633	3 in	Hook w/Latch	5/8 in	1500 lb	2.50 lb

BLOCKS

## Try Net Block, 6150T

- Model 6150T
- Forged Steel Swivel Eye
- Hardened Steel Sheave for Wear Resistance
- Bronze Bushing with Pressure Greased Lubrication
- Galvanized Finish

Catalog No.	UPC No. 020418	Block Size	Working Load Limit (Metric Tons)	Weight Each
7399058	130472	6 in	3 t	19.00 lb
7399158	130496	6 in	5 t	22.00 lb



## Come-Along Hook, No. 5012

- Model 5012
- Public Utility Specialty Item
- 1/2" Forged Steel
- Swivel Eye
- Galvanized Finish

Catalog No.	UPC No. 020418	Material Diameter	Finish	Weight Each
7380101	129742	1/2 in	Galvanized	19.00 lb







**SLINGS**

Cam Alloy Sling Hooks.....	142
Replacement Latches .....	143
Cam Alloy Foundry Hooks.....	143
Cam Alloy Grab Hooks .....	144
Swivel Hooks .....	145
Links .....	145
Coupling Links .....	149
Sling Hooks (Regular and Latched).....	150
Quik Alloy Grab Hooks .....	151
Clevis Hooks .....	152
Hook Repair Kits .....	152
Cam Alloy Hooks "S" and "J" .....	153
Field I.D. Tags.....	153

## Campbell® Slings

Founded in 1919, Campbell is the largest manufacturer of welded and weldless chain in the United States. Users of Campbell chain can select from a wide range of working load capacities including proof coil, high test, transport and alloy; finishes including self-colored, Blu-Krome®, galvanized and bright color polycoated; links that are short, long, twisted, locked, looped, even stamped from flat stock. Several chain types are even available in solid brass and bronze.

Campbell chains and assemblies, including slings for overhead lifting, tie-downs and binder chains, have earned for the manufacturer an outstanding reputation for quality.

## Campbell's Chain Sling Program Surveys, Seminars and Schools

Users of Campbell Chain Slings may receive annual surveys to assure compliance with OSHA standards. These thorough in-plant inspections by qualified Apex Tool Group/Campbell personnel can point out potential problems, encourage proper handling and storage, show how to reduce inventory and increase productivity.

Upon completion of the survey, Campbell will provide a complete report on the status of every Campbell chain sling and clamp for your OSHA compliance files.

To instruct customers in the proper use of slings as well as in maintenance and safety procedures, Campbell will conduct seminars in your plant or at its local sling repair center. Further, if interested, we'll train your plant personnel to conduct their own sling survey in a one and a half day "school" held at our York, Pennsylvania plant. Upon completion of this school, your personnel will be fully qualified to perform OSHA compliance inspections.

Campbell's sling repair centers across the U.S. help make the most of your company's chain sling investment. Wherever economical reconditioning is possible, Campbell will advise you on estimated cost. A nearby center will then repair, proof-test and issue new certificates of test to put your slings back to work quickly.

## To Supplement Your Sling Chain Program

**CAMPBELL**

**CAM-ALLOY CHAIN SLINGS — GRADE 80 WORKING LOAD LIMITS\* (LBS.)**

THREE SIZE RINGS	SINGLE SLING TYPE 1	SINGLE SLING TYPE 2	SINGLE SLING TYPE 3	SINGLE SLING TYPE 4	SINGLE SLING TYPE 5	THREE SIZE ONE		
7/32	2100	3800	3000	2100	5500	4500	3200	5.5
9/32	3500	6100	4900	3500	9100	7400	5200	7
5/16	4500	7700	6300	4500	11700	9400	6700	8
3/8	7100	12300	10000	7100	18400	15100	10600	10
1/2	12000	20800	17000	12000	31200	25500	18000	13
5/8	18100	31300	25600	18100	47000	38400	27100	16
3/4	26300	49000	40000	26300	73500	60000	42400	20
7/8	34200	63200	49400	34200	89900	72500	51300	22
1	47700	82600	67400	47700	123900	101200	71500	25
1-1/4	72300	125200	102200	72300	187800	153400	108400	32

**100% AMERICAN STRONG FROM CHAIN TO HOOK!**

**CAMPBELL**

**CAM-ALLOY CHAIN SLINGS — GRADE 100 WORKING LOAD LIMITS\* (LBS.)**

THREE SIZE RINGS	SINGLE SLING TYPE 1	SINGLE SLING TYPE 2	SINGLE SLING TYPE 3	SINGLE SLING TYPE 4	SINGLE SLING TYPE 5	THREE SIZE ONE		
9/32	4300	7400	6100	4300	11200	9100	6400	7
5/16	5700	9900	8100	5700	14800	12100	8500	8
3/8	8800	15200	12400	8800	22900	18700	13200	10
1/2	15000	26000	21200	15000	39000	31800	22500	13
5/8	22600	39100	32000	22600	58700	47900	33900	16
3/4	35300	61100	49900	35300	91700	74900	53000	20
7/8	42700	74000	60400	42700	110900	90600	64000	22

**100% AMERICAN STRONG FROM CHAIN TO HOOK!**

Number T550922 and T550923

**Campbell® Sling Chain Inspection Record**

Shop: \_\_\_\_\_ Grade: \_\_\_\_\_ Serial No.: \_\_\_\_\_  
 Type: \_\_\_\_\_ Size: \_\_\_\_\_ Reach: \_\_\_\_\_ Working Load Limit: \_\_\_\_\_  
 When Made: \_\_\_\_\_

Made to Print No.: \_\_\_\_\_ Revisions: \_\_\_\_\_

Attachments or Special Features: \_\_\_\_\_

Put in Service: \_\_\_\_\_ Cost of Sling (New): \_\_\_\_\_

Returned for Repair: \_\_\_\_\_

Returned to Service: \_\_\_\_\_

Cost of Repair: \_\_\_\_\_

Condition: \_\_\_\_\_ Date: \_\_\_\_\_ By: \_\_\_\_\_

© 2014 1005888 (CAMBELL) (CAMBELL) 1204 USA (CAMBELL) NO. 0008-1 © 2014, Campbell Industrial, Inc.

Number T550864

**Campbell®**

**Slings, Surveys and Safety**

- Chain Sling Inspection
- Rejection Criteria
- Proper Use of Slings
- Safe Lifting Practices
- Clamp Operating Guide



English Number T550840  
 French/Spanish Number T550841

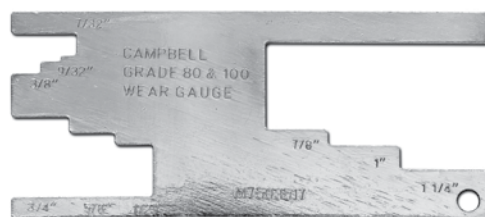

Number 7503515

**SLINGS**



## Campbell Service Centers

### Chicago Area

Alloy Sling Chain Industries, LTD  
1406 West 175th Street  
East Hazelcrest, IL 60429-1820  
Phone: (708) 647-4900  
Toll Free: (800) 255-8973  
Fax: (708) 647-4993

### Detroit Area

Commercial Group Lifting  
Products/Detroit Chain  
12801 Universal Drive  
Taylor, MI 48180  
Phone: 734-947-4000  
Fax: 734-947-4004

### Philadelphia Area

I & I Sling Company  
2626 Market St.  
Box 2423  
Aston, PA 19014  
Phone: (610) 485-8500  
Fax: (610) 494-5835

### San Francisco Area

Carpenter Rigging & Supply  
222 Napoleon Street  
San Francisco, CA 92124  
Phone: (415) 285-1954  
Fax: (415) 285-0176

### Cleveland Area

Commercial Group Lifting  
Products/Great Lakes  
5213 Grant Avenue  
Cleveland, OH 44125  
Phone: (216) 641-4100  
Fax: (216) 641-1814

### Houston Area

Bishop Lifting Products, Inc.  
125 McCarthy Drive  
Houston, TX 77029  
Phone: (800) 972-1041  
www.lifting.com

### Pittsburgh Area

Safety Sling Company, Inc.  
919 Fulton Street  
Pittsburgh, PA 15233  
Phone: (412) 231-6684  
Fax: (412) 231-6695

### Quebec, Canada

St-Pierre Chains & Slings, LTD  
7690 Jarry Street E  
Anjou, Quebec  
Canada H1J 2M3  
Phone: (514) 354-4219  
Fax: (514) 354-5059

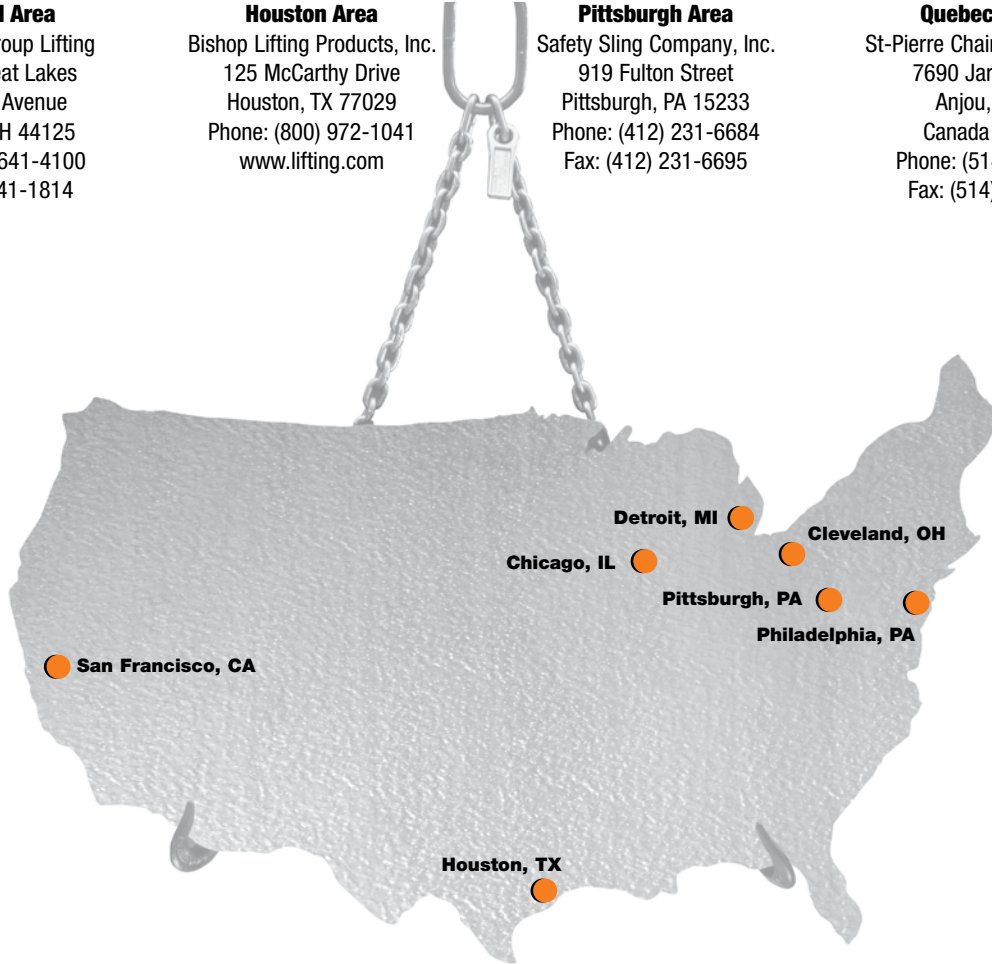

## Dependable chain slings. Strong national service network



Our service network is composed of ten authorized service centers in all, each strategically located across the United States and Canada, to offer fast, dependable service for your chain sling requirements.

Specifically, our chain sling service program offers on-site chain inspections, including a complete report showing the status of all chain slings and Campbell clamps for your OSHA compliance files. All chain slings are fabricated precisely to Campbell's manufacturing specifications. The program also includes in-plant seminars to educate your employees in proper and safe chain sling procedures. Our Campbell Chain facility in York, PA even conducts chain sling schools, free of charge.

Each of our eleven authorized repair facilities has technical and sales support ready to assist you in resolving your overhead lifting needs. Which further proves what we have said all along: Dependable chain slings, strong national service network.

# Rated Loads For Grade 80 (System 8) Alloy Steel Chain Slings

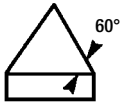
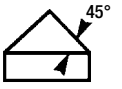
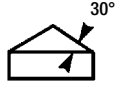
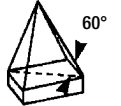
## Rated Load for Grade 80 Alloy Steel Chain Slings

Chain Size Nominal		Single Leg Sling - 90° - Horizontal Loading		Rated load Double Leg Sling and Single Basket at Horizontal Angle						Triple and Quadruple Leg Sling and Double Basket at Horizontal Angle					
				60°		45°		30°		60°		45°		30°	
															
in.	mm	lb	kg	lb	kg	lb	kg	lb	kg	lb	kg	lb	kg	lb	kg
7/32	5.5	2,100	950	3,600	1,650	3,000	1,350	2,100	950	5,500	2,450	4,400	2,000	3,200	1,450
9/32	7	3,500	1,600	6,100	2,750	4,900	2,250	3,500	1,600	9,100	4,150	7,400	3,400	5,200	2,400
3/8	10	7,100	3,200	12,300	5,550	10,000	4,500	7,100	3,200	18,400	8,300	15,100	6,800	10,600	4,800
1/2	13	12,000	5,400	20,800	9,450	17,000	7,700	12,000	5,400	31,200	14,150	25,500	11,550	18,000	8,200
5/8	16	18,100	8,200	31,300	14,200	25,600	11,600	18,100	8,200	47,000	21,300	38,400	17,400	27,100	12,300
3/4	20	28,300	12,800	49,000	22,250	40,000	18,150	28,300	12,800	73,500	33,400	60,000	27,250	42,400	19,300
7/8	22	34,200	15,500	59,200	26,850	48,400	21,900	34,200	15,500	88,900	40,250	72,500	32,900	51,300	23,250
1	26	47,700	21,600	82,600	37,500	67,400	30,600	47,700	21,600	123,900	56,250	101,200	45,950	71,500	32,500
1-1/4	32	72,300	32,800	125,200	56,800	102,200	46,400	72,300	32,800	187,800	85,200	153,400	69,600	108,400	49,200

## Rated Loads for Grade 80 Alloy Steel Chain Slings - Choker Hitches

Chain Size Nominal		Single Leg		Double Leg and Single Baskets						Triple and Quadruple Leg; Double Baskets					
		90°		60°		45°		30°		60°		45°		30°	
in.	mm	lb	kg	lb	kg	lb	kg	lb	kg	lb	kg	lb	kg	lb	kg
7/32	5.5	1,700	750	2,900	1,300	2,400	1,100	1,700	750	4,400	1,950	3,500	1,600	2,550	1,150
9/32	7	2,800	1,300	5,000	2,200	3,900	1,800	2,800	1,300	7,300	3,300	5,900	2,700	4,150	1,900
3/8	10	5,700	2,550	9,800	4,450	8,000	3,650	5,700	2,550	14,700	6,650	12,100	5,450	8,500	3,850
1/2	13	9,600	4,300	16,600	7,550	13,600	6,150	9,600	4,300	25,000	11,300	20,400	9,250	14,400	6,550
5/8	16	14,500	6,550	25,000	11,350	20,500	9,300	14,500	6,550	37,600	17,050	30,700	13,900	21,700	9,850
3/4	20	22,600	10,250	39,200	17,800	32,000	14,500	22,600	10,250	58,800	26,700	48,000	21,800	33,900	15,450
7/8	22	27,400	12,400	47,400	21,500	38,700	17,500	27,400	12,400	71,100	32,200	58,000	26,300	41,000	18,600
1	26	38,200	17,300	66,100	30,000	53,900	24,500	38,200	17,300	99,100	45,000	81,000	36,750	57,200	26,000
1-1/4	32	57,800	26,250	100,200	45,450	81,800	37,100	57,800	26,250	150,200	68,150	122,700	55,700	86,700	39,350



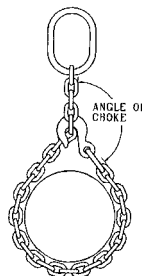

Note: Angle of choke should be greater than 120°



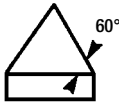
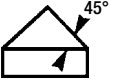

# Rated Loads For Grade 80 (System 8) Alloy Steel Chain Slings

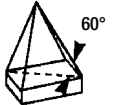
## Rated Load for Grade 80 Alloy Steel Chain Slings

Chain Size Nominal		Single Leg Sling - 90° - Horizontal Loading		Rated load Double Leg Sling and Single Basket at Horizontal Angle						Triple and Quadruple Leg Sling and Double Basket at Horizontal Angle					
				60°		45°		30°		60°		45°		30°	
															
in.	mm	lb	kg	lb	kg	lb	kg	lb	kg	lb	kg	lb	kg	lb	kg
7/32	5.5	2,100	950	3,600	1,650	3,000	1,350	2,100	950	5,500	2,450	4,400	2,000	3,200	1,450
9/32	7	3,500	1,600	6,100	2,750	4,900	2,250	3,500	1,600	9,100	4,150	7,400	3,400	5,200	2,400
3/8	10	7,100	3,200	12,300	5,550	10,000	4,500	7,100	3,200	18,400	8,300	15,100	6,800	10,600	4,800
1/2	13	12,000	5,400	20,800	9,450	17,000	7,700	12,000	5,400	31,200	14,150	25,500	11,550	18,000	8,200
5/8	16	18,100	8,200	31,300	14,200	25,600	11,600	18,100	8,200	47,000	21,300	38,400	17,400	27,100	12,300
3/4	20	28,300	12,800	49,000	22,250	40,000	18,150	28,300	12,800	73,500	33,400	60,000	27,250	42,400	19,300
7/8	22	34,200	15,500	59,200	26,850	48,400	21,900	34,200	15,500	88,900	40,250	72,500	32,900	51,300	23,250
1	26	47,700	21,600	82,600	37,500	67,400	30,600	47,700	21,600	123,900	56,250	101,200	45,950	71,500	32,500
1 1/4	32	72,300	32,800	125,200	56,800	102,200	46,400	72,300	32,800	187,800	85,200	153,400	69,600	108,400	49,200

## Rated Loads for Grade 80 Alloy Steel Chain Slings - Choker Hitches

Chain Size Nominal		Single Leg		Double Leg and Single Baskets						Triple and Quadruple Leg; Double Baskets					
		90°		60°		45°		30°		60°		45°		30°	
in.	mm	lb	kg	lb	kg	lb	kg	lb	kg	lb	kg	lb	kg	lb	kg
7/32	5.5	1,700	750	2,900	1,300	2,400	1,100	1,700	750	4,400	1,950	3,500	1,600	2,550	1,150
9/32	7	2,800	1,300	5,000	2,200	3,900	1,800	2,800	1,300	7,300	3,300	5,900	2,700	4,150	1,900
3/8	10	5,700	2,550	9,800	4,450	8,000	3,650	5,700	2,550	14,700	6,650	12,100	5,450	8,500	3,850
1/2	13	9,600	4,300	16,600	7,550	13,600	6,150	9,600	4,300	25,000	11,300	20,400	9,250	14,400	6,550
5/8	16	14,500	6,550	25,000	11,350	20,500	9,300	14,500	6,550	37,600	17,050	30,700	13,900	21,700	9,850
3/4	20	22,600	10,250	39,200	17,800	32,000	14,500	22,600	10,250	58,800	26,700	48,000	21,800	33,900	15,450
7/8	22	27,400	12,400	47,400	21,500	38,700	17,500	27,400	12,400	71,100	32,200	58,000	26,300	41,000	18,600
1	26	38,200	17,300	66,100	30,000	53,900	24,500	38,200	17,300	99,100	45,000	81,000	36,750	57,200	26,000
1-1/4	32	57,800	26,250	100,200	45,450	81,800	37,100	57,800	26,250	150,200	68,150	122,700	55,700	86,700	39,350

Note: Angle of choke should be greater than 120°

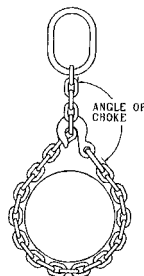

# Rated Loads For Grade 100 (System 10) Alloy Steel Chain Slings

## Rated Load for Grade 100 Alloy Steel Chain Slings

Chain Size Nominal		Single Leg Sling - 90° - Horizontal Loading		Rated load Double Leg Sling and Single Basket at Horizontal Angle						Triple and Quadruple Leg Sling and Double Basket at Horizontal Angle					
				60°		45°		30°		60°		45°		30°	
				Double at 60°		Double at 45°		Double at 30°		Quad at 60°		Quad at 45°		Quad at 30°	
in.	mm	lb	kg	lb	kg	lb	kg	lb	kg	lb	kg	lb	kg	lb	kg
9/32	7	4,300	1,950	7,400	3,400	6,100	2,750	4,300	1,950	11,200	5,050	9,100	4,150	6,400	2,950
3/8	10	8,800	4,000	15,200	6,950	12,400	5,650	8,800	4,000	22,900	10,400	18,700	8,500	13,200	6,000
1/2	13	15,000	6,800	26,000	11,800	21,200	9,600	15,000	6,800	39,000	17,650	31,800	14,450	22,500	10,200
5/8	16	22,600	10,300	39,100	17,750	32,000	14,500	22,600	10,300	58,700	26,650	47,900	21,750	33,900	15,400
3/4	20	35,300	16,000	61,100	27,700	49,900	22,650	35,300	16,000	91,700	41,550	74,900	33,950	53,000	24,000
7/8	22	42,700	19,400	74,000	33,500	60,400	27,350	42,700	19,400	110,900	50,250	90,600	41,050	64,000	29,050

## Rated Loads for Grade 100 Alloy Steel Chain Slings - Choker Hitches

Chain Size Nominal		Single Leg		Double Leg and Single Baskets						Triple and Quadruple Leg; Double Baskets					
		90°		60°		45°		30°		60°		45°		30°	
in.	mm	lb	kg	lb	kg	lb	kg	lb	kg	lb	kg	lb	kg	lb	kg
9/32	7	3,500	1,600	6,100	2,750	4,900	2,250	3,500	1,600	9,100	4,150	7,400	3,400	5,200	2,400
3/8	10	7,100	3,200	12,300	5,550	10,000	4,550	7,100	3,200	18,400	8,300	15,100	6,800	10,600	4,800
1/2	13	12,000	5,400	20,800	9,450	17,000	7,700	12,000	5,400	31,200	14,150	25,500	11,550	18,000	8,200
5/8	16	18,100	8,200	31,300	14,200	25,600	11,600	18,100	8,200	47,000	21,300	38,400	17,400	27,100	12,300
3/4	20	28,300	12,800	49,000	22,250	40,000	18,150	28,300	12,800	73,500	33,400	60,000	27,250	42,400	19,300
7/8	22	34,200	15,500	59,200	26,850	48,400	21,900	34,200	15,500	88,900	40,250	72,500	32,900	51,300	23,250

Note: Angle of choke should be greater than 120°

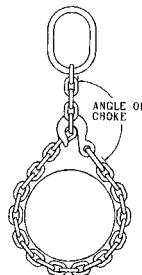

## Cam-Alloy Chain Slings

Campbell manufactures a complete line of standard sling assemblies, as well as assemblies to customer specifications. This work is done at authorized Campbell Sling Service Centers located in strategic areas of the country to provide maximum customer service.



## Important Chain Terms

### WORKING LOAD LIMIT

The “working load limit” (rated capacity) is the maximum combined static and dynamic load in pounds or kilograms which should ever be applied to the product in service, even when the product is new, and when the load is uniformly applied in direct tension to the product.

### PROOF TEST

The “proof test” is a quality control test applied to chain for the purpose of verifying weld and material quality. It is the minimum force in pounds or newtons that the chain has withstood in direct tension as part of the manufacturing process. Proof testing assures that the chain is more than capable of performing at its rated working load limit. Proof test loads are a manufacturing integrity test and shall not be used as criteria for service or design purposes. All Campbell chain and components are proof tested in accordance with the applicable ASTM, NACM, OSHA and AISI/ASME requirements.

## Certificate of Test and Identification Tags

Campbell provides information in several forms that enables purchasers and users to operate safely and effectively in conformity with OSHA requirements. The drop forged Identification Tag is attached to the Master End Coupling link of each chain sling and provides the following lifetime information:

- Grade
- Working Load Limit (at a specific angle of lift)
- Size
- Serial number
- Reach
- Type

A Certificate of Test is provided for every Campbell manufactured chain sling. The Campbell Certificate contains all of the information provided on the identification tag, plus the Proof Test load as required by OSHA regulations.



## Basic Types of Chain Slings

Slings are designated throughout the industry by the symbols.

### First Symbol (Basic Type - number of legs)

- S** Single Chain Sling with master link and hook, or hook each end.
- C** Single Choker Chain Sling with master link each end. No hooks.
- D** Double Chain Sling with standard master link and hooks.
- T** Triple Chain Sling with standard master link and hooks.
- Q** Quadruple Chain Sling with standard master link and hooks.
- SB** Single basket
- DB** Double basket

### Second Symbol (Type of master link, end link or type of hook)

- O** Standard Oblong Master Link – Recommended for all types.

### Third Symbol (Type of Hooks)

- S** Sling Hook
- G** Grab Hook
- CG** Cradle Grab Hook
- F** Foundry Hook
- J** Hook
- SL** Self-locking Hook

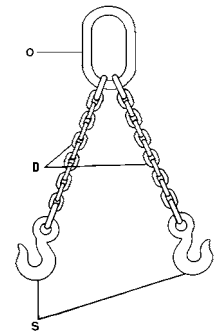

## How to Order Chain Slings

1. Determine the maximum load to be lifted.
2. Refer to the following pages and choose the proper type of chain sling (single, double etc.) dictated by the size, shape and weight of the load.
3. Estimate the approximate angle between a leg of the sling and the load during operation.
4. Select the proper attachments (hooks and master links) for your chain sling.
5. Determine the overall reach from bearing point on master link to bearing point on attachment.
6. Refer to the Working Load Limit Chart and to your predetermined angle of the type sling you have selected.
7. Choose the chain size which meets your requirements.
8. When ordering, be sure you give complete information as to the size, reach and attachments required.

*Note: Angle to the load on multiple leg slings will be 60° or greater as long as the distance between lifting eyes of load is not greater than reach shown on identification tag.*

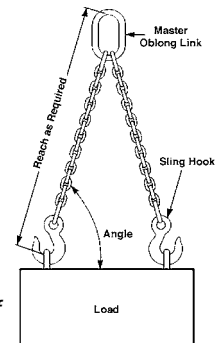

# Inspection, Care and Proper Use of Chain Slings

Campbell welded chain products and components are designed and built for rugged lasting service. As with any quality product certain precautions and standards of treatment should be observed. Proper care will extend the useful life of the product.

## INSTRUCTIONS REGARDING COMPONENTS & FITTINGS

Components, such as master links and hooks, should have at least the same working load limit (rated capacity) as the chain with which they are used. If not, the sling shall be rated to the capacity of the weakest component. Campbell offers a full line of Cam-Alloy® and Quik-Alloy® sling components engineered specifically to be compatible with our alloy chain products.

## WARNINGS AND CAUTIONS

- The use of chain, slings, and components are subject to certain hazards that cannot be met by mechanical or manufacturing means, but only by the exercise of intelligence, care, and common sense
- Sling use is subject to the Occupational Safety & Health Administration (OSHA 29 CFR 1910.184) and American Society for Mechanical Engineers (ASME B30.9) safety standards, requiring the sling user to conduct safe working practices and perform inspections
- Do not exceed the working load limit of the sling or any component
- Chemically active environments may adversely affect chain slings. Do not use in highly acidic or caustic environments. Campbell should be contacted if the sling will be exposed to chemically active environments during use
- High and low temperatures will affect chain slings. Campbell should be contacted if temperatures below -20°F (-29°C) will be experienced. The **Effect of Elevated Temperature on the Working Load Limit of Alloy Chain** chart shows the reduction in strength that occurs when chain slings are used at or have been exposed to temperatures above 400°F (204°C)
- Never field weld or repair a chain sling. Chain slings should only be repaired by a qualified repair facility
- See information under the Care, Inspection, and Proper Use sections

## INSPECTION

OSHA and ASME safety standards require the user to conduct:

- Frequent Inspections: A visual inspection for damage, which should be performed each day the sling is used.
- Periodic Inspections: A complete link by link and component inspection. Periodic inspection intervals vary depending on sling usage and conditions, but must occur at least annually. Written records of periodic inspections are required. The slings should be inspected for the presence damage. The sling should immediately be removed from service if any of the following conditions are present:
  - Missing or unreadable identification tag
  - Cracks in the chain or any component
  - Excessive nicks, gouges or wear. Chain should be removed from service if the thickness at any point on the link is below the value shown in the **Cam-Alloy Chain Minimum Allowable Thickness** chart. All other components should be removed from service if any dimension is worn more than 10% from the original dimension

## Cam-Alloy Chain - Minimum Allowable Thickness

Chain Size		Cat. No. Drum	Actual Size Stock Dia.		Min. Allowable Thickness on Any	
in.	mm		in.	mm	in.	mm
$\frac{9}{32}$	7	0405212	.282	7	.239	6.07
$\frac{3}{8}$	10	0405412	.402	10	.342	8.69
$\frac{1}{2}$	13	0405512	.522	13	.443	11.26
$\frac{5}{8}$	16	0405612	.643	16	.546	13.87
$\frac{3}{4}$	20	0405712	.802	20	.687	17.45
$\frac{7}{8}$	22	0405812	.881	22	.750	19.05
1	26	0401612	1.000	25	.887	22.53
$1\frac{1}{4}$	32	0402012	1.250	32	1.091	27.71

- Stretched, bent, twisted, or distorted chain links or components
- Excessive corrosion
- Evidence of heat damage
- Evidence of field welding or weld spatter
- Any other condition which questions the integrity of the chain sling
- Any side movement of the Quik Alloy Coupling Link Pin could indicate excessive wear of the pin or link half and be cause for removal from service
- Depending on the severity of use and environment, individual Quik-Alloy components should be disassembled so that load pins may be thoroughly inspected

## CARE

- Chain slings should be stored in a clean and dry area, preferably on a rack, in order to extend their life
- Chain slings should not be stored in areas where they would be subject to damage, corrosion, chemical attack, or extreme temperatures
- Clean slings periodically, as dust and grit can accelerate wear
- During use, chain slings should not be dragged over abrasive surfaces. Loads should not be rested on the chain sling to avoid damage

## PROPER USE

To protect the operators, the load, and the sling, the following safe practices should be followed. Campbell also recommends compliance with the OSHA and ASME safety standard practices.

- Select a sling suitable for the load, type of hitch, angle of loading, and environment. The hooks and master links should be of a size to fit the intended connections
- Avoid shock loading
- Pad all sharp edges or corners in contact with the sling to prevent damage to either the sling or the load
- Balance the load to prevent shifting, to maintain control of the load, and to prevent overloading of any leg in a multiple leg sling
- Rig so that the load is properly seated in the hooks and master link. Avoid tip loading of hooks and side loading of master links
- Avoid twisting or kinking of sling legs
- Never knot chain legs
- Horizontal angles less than 30° should not be used without consulting Campbell or a qualified person
- For choker hitches, angles of choke greater than 120° should not be used without consulting Campbell or a qualified person. Choker hitches reduce the working load limit by 20% (See pages 186 & 187)
- For basket hitches, the minimum recommended diameter of the load is 6 times the nominal chain diameter. The attached D/d chart shows the reduction in the WLL for D/d ratios less than 6.

## Effect of Elevated Temperature on the Working Load Limit of Alloy Chain

Temperature		Grade of Chain			
		Grade 80 (System8)		Grade 100 (System 10)	
(F°)	(C°)	Reduction of Working Load Limit WHILE AT Temperature	Reduction of Working Load Limit AFTER EXPOSURE to Temperature	Reduction of Working Load Limit WHILE AT Temperature	Reduction of Working Load Limit AFTER EXPOSURE to Temperature
< 400°	< 204°	None	None	None	None
400°	204°	10%	None	15%	None
500°	260°	15%	None	25%	5%
600°	316°	20%	5%	30%	15%
700°	371°	30%	10%	40%	20%
800°	427°	40%	15%	50%	25%
900°	482°	50%	20%	60%	30%
1000°	538°	60%	25%	70%	35%

>1000° >538° OSHA requires that any chain sling which has experienced temperatures in excess of 1000° F be removed from service.





## Cam-Alloy Chain Slings

### How Lifting Angles Reduce Working Load Limits of Slings

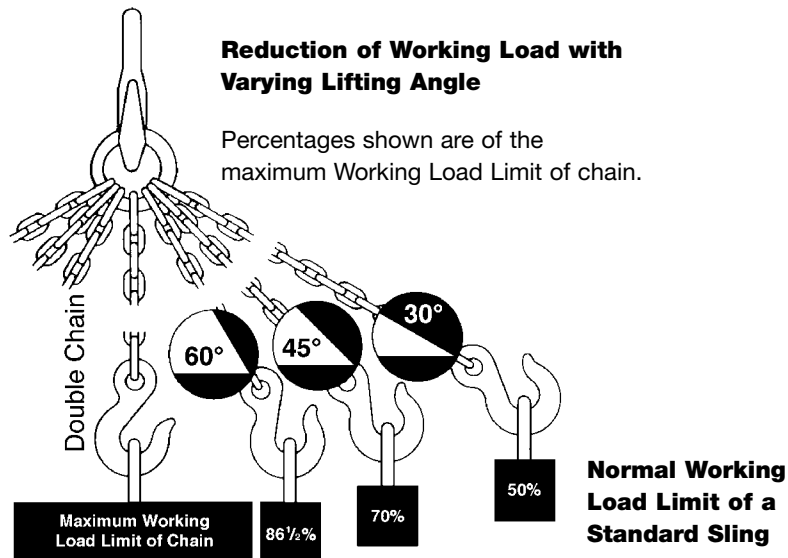

## Cam-Alloy Chain Specifications

Cam-Alloy steel chain is electrically welded alloy steel embodying the latest manufacturing technology. Alloy provides a superior chain sling with high tensile strength and excellent wear resistance. The following chains meet or exceed all existing OSHA, ANSI, ASME, NACM and ASTM specification requirements.

The Cam-Alloy chain and attachments used in fabricating Campbell chain slings offer a design factor of 4 to 1. System 8 is Campbell's trade name for Grade 80 chain. System 10 is Campbell's trade name for Grade 100 chain.

Trade Size	Nominal Dimensions (in. and mm)										Drum	Working Load Limit		Feet/ Drum	Lb/ 100ft.	Links/ ft.
	Material Diameter		Inside Dimensions				Cat. No.	UPC No. 020418	lb	kg						
	in.	mm	Grade	Length		Width										
9/32	7	100	.29	7	.86	22	.41	10	0405212	182204	4300	1950	500	74	13.8	
5/16	8	80	.32	8	.94	24	.46	12	0400512	063367	4500	2000	500	92	12.8	
5/16	8	100	.33	8	1.01	26	.50	13	0405312	245510	5700	2600	500	104	12	
3/8	10	100	.40	10	1.22	31	.57	14	0405412	182211	8800	3990	500	148	10.0	
1/2	13	100	.52	13	1.57	40	.75	19	0405512	182228	15,000	6800	300	250	7.8	
5/8	16	100	.64	16	1.93	49	.87	22	0405612	182235	22,600	10,250	200	379	6.5	
3/4	20	100	.80	20	2.42	61	1.09	28	0405712	182242	35,300	16,000	100	610	4.9	
7/8	22	100	.88	22	2.70	69	1.28	31	0405812	063497	42,700	19,400	100	775	4.4	
1	26	80	1.00	25	2.80	71	1.40	36	0401612	063510	47,700	21,600	100	965	4.3	
1 1/4	32	80	1.25	32	3.50	89	1.75	44	0402012	063534	72,300	32,800	60	1525	3.5	

The last digit of the catalog number changes to a 1 if a non-standard quantity is ordered.

**NOTICE: The product specifications and dimensions are as accurate as possible at the time of printing. However, because we are constantly improving the quality and design of our product, they can change without notice.**

Purchasers please note that all "Warnings and Cautions" apply to chain, components and fittings, as well as chain slings. Purchasers are responsible for conveying the "Warnings and Cautions" including the "Inspection, Care and Proper Use" section information to the end user. Campbell denies any liability for damage that results from use in excess of the working load limit or any abuse or misuse of the product. Any questions concerning the use of Campbell products may be directed to your Apex Tool Group Sales Representative or Customer Service.

## Cam-Alloy Chain Slings Single Types: S and C

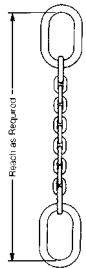

Type C0

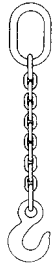

Type S0S

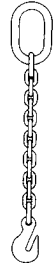

Type S0G

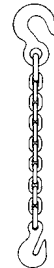

Type S0G

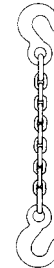

Type S0S

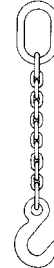

Type S0F

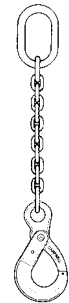

Type S0SL

Chain Size		System	Oblong Link							Working Load Limit	
			Nominal Size Material		Inside Dimensions						
			in.	mm	Width		Length				
9/32	7	10	37/64	15	2 1/2	64	5	127	4,300	1,950	
3/8	10	10	13/16	21	3	76	6	152	8,800	4,000	
1/2	13	10	1 1/8	29	4	102	8	203	15,000	6,800	
5/8	16	10	1 1/8	29	4	102	8	203	22,600	10,300	
3/4	20	10	1 1/4	32	4	102	8	203	35,300	16,000	
7/8	22	10	1 5/8	41	5 1/4	133	10 1/2	267	42,700	19,400	
1	26	8	1 7/8	48	6	152	12	305	47,700	21,600	
1 1/4	32	8	2	51	7	178	14	356	72,300	32,800	

Dimensions are approximate. Single chain slings are available in other combinations. These items are made to order.

## Cam-Alloy Chain Slings Double Type: D

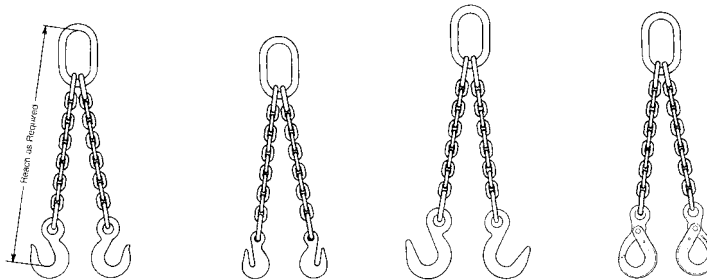

Chain Size		System	Oblong Master Link							Working Load Limit					
			Nominal Size Material		Inside Dimensions				Double at 60°		Double at 45°		Double at 30°		
			in.	mm	Width		Length		lb	kg	lb	kg	lb	kg	
9/32	7	10	37/64	15	2 1/2	64	5	127	7,400	3,400	6,100	2,700	4,300	1,950	
3/8	10	10	13/16	21	3	76	6	152	15,200	6,900	12,400	6,900	8,800	3,990	
1/2	13	10	1 1/8	29	4	102	8	203	26,000	11,800	21,200	9,600	15,000	6,800	
5/8	16	10	1 1/4	32	4	102	8	203	39,100	17,700	32,000	14,500	22,600	10,300	
3/4	20	10	1 5/8	41	5 1/4	133	10 1/2	267	61,100	27,700	49,900	22,600	35,300	16,000	
7/8	22	10	1 7/8	48	6	152	12	305	74,000	33,500	60,400	27,350	42,700	19,400	
1	26	8	2	51	7	178	14	356	82,600	37,900	67,400	31,000	47,700	21,600	
1 1/4	32	8	2 1/4	57	8	203	16	406	125,200	56,800	102,200	46,400	72,300	32,800	

Dimensions are approximate. Double chain slings are available in other combinations. These items are made to order.



## Cam-Alloy Chain Slings Triple Type: T

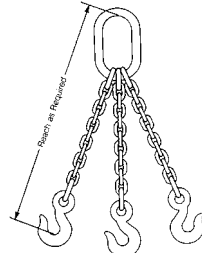

Type TOS

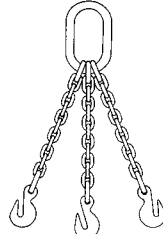

Type TOG



Type TOSL

Chain Size		System	Oblong Master Link							Working Load Limit						
			Nominal Size Material		Inside Dimensions					60°		45°		30°		
					Width		Length			Triple at 60°		Triple at 45°		Triple at 30°		
in.	mm	in.	mm	in.	mm	in.	mm	in.	mm	lb	kg	lb	kg	lb	kg	
9/32	7	10	13/16	21	3	76	6	152			11,200	5,100	9,100	4,100	6,450	2,900
3/8	10	10	1 1/8	29	4	102	8	203			22,800	10,300	18,600	8,400	13,200	6,000
1/2	13	10	1 1/4	32	4	102	8	203			39,000	17,700	31,800	14,400	22,500	10,200
5/8	16	10	1 5/8	41	5 1/4	133	10 1/2	267			58,700	26,600	47,900	21,700	33,900	15,400
3/4	20	10	1 7/8	48	6	152	12	305			91,700	41,600	74,900	34,000	53,000	24,000
7/8	22	10	2 1/4	57	8	203	16	406			110,900	50,250	90,600	41,050	64,000	29,050
1	26	8	2 1/4	57	8	203	16	406			123,900	56,900	101,200	46,500	71,500	32,800
1 1/4	32	8	2 3/4	70	9	229	16	406			187,800	85,200	153,400	69,600	108,400	49,200

Dimensions are approximate. Triple chain slings are available in other combinations. These items are made to order.

## Cam-Alloy Chain Slings Quadruple Type: Q

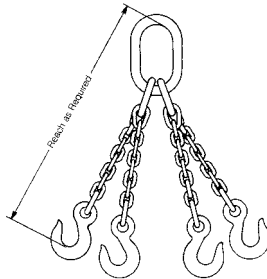

Type QOS

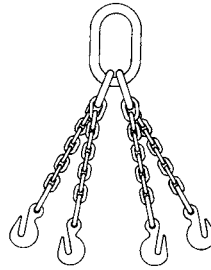

Type QOG



Type QOSL

Chain Size		System	Oblong Master Link						Master Coupling Link						Working Load Limit									
			Nominal Size Material		Inside Dimensions				Nominal Size Material		Inside Dimensions				60°		45°		30°					
					Width		Length				Width		Length		Quad at 60°		Quad at 45°		Quad at 30°					
in.	mm	in.	mm	in.	mm	in.	mm	in.	mm	in.	mm	in.	mm	in.	mm	in.	mm	lb	kg	lb	kg	lb	kg	
9/32	7	10	13/16	21	3	76	6	152	17/32	13	1 1/2	38	2 5/8	67					11,200	5,100	9,100	4,100	6,450	2,900
3/8	10	10	1 1/8	29	4	102	8	203	25/32	20	1 5/8	41	2 7/8	73					22,800	10,300	18,600	8,400	13,200	6,000
1/2	13	10	1 1/4	32	4	102	8	203	1	25	3	76	5	127					39,000	17,700	31,800	14,400	22,500	10,200
5/8	16	10	1 5/8	41	5 1/4	133	10 1/2	267	1 1/4	32	4	102	6	152					58,700	26,600	47,900	21,700	33,900	15,400
3/4	20	10	1 7/8	48	6	152	12	305	1 1/2	38	4	102	6	152					91,700	41,600	74,900	34,000	53,000	24,000
7/8	22	10	2 1/4	57	8	203	16	406	1 3/4	44	4	102	6	152					110,900	50,250	90,600	41,050	64,000	29,050
1	26	8	2 1/4	57	8	203	16	406	1 7/8	48	5	127	7	178					123,900	56,900	101,200	46,500	71,500	32,800
1 1/4	32	8	2 3/4	70	9	229	16	406	2 1/8	54	6	152	9	229					187,800	85,200	153,400	69,600	108,400	49,200

Dimensions are approximate. Quadruple chain slings are available in other combinations. **NOTE:** In practice hooks on "Q" slings are in the plane opposite that shown.

† See Oblong Master Link Sub-Assembly for complete dimensions. These items are made to order.

## Miscellaneous Cam-Alloy Chain Slings Types Single Adjustable

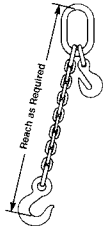

Style A



Style B

Standard with 1 foot of chain in short leg.

Chain Size	in.	mm	System	Oblong Master Link					Working Load Limit at 90°	
				Nominal Size Material		Inside Dimensions				
				in.	mm	Width	Length		lb	kg
9/32	7	10	37/64	15	2 1/2	64	5	127	4,300	1,950
3/8	10	10	13/16	21	3	76	6	152	8,800	4,000
1/2	13	10	1 1/8	29	4	102	8	203	15,000	6,800
5/8	16	10	1 1/8	29	4	102	8	203	22,600	10,300
3/4	20	10	1 1/4	32	4	102	8	203	35,300	16,000
7/8	22	10	1 5/8	41	5 1/4	133	10 1/2	267	42,700	19,400
1	26	8	1 7/8	48	6	152	12	305	47,700	21,600
1 1/4	32	8	2	51	7	178	14	356	72,300	32,800

Dimensions are approximate. These items are made to order.

## Cam-Alloy Chain Slings Single Adjustable Loop

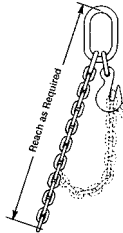

Style A

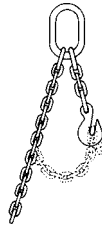

Style B

Standard with 1 foot of chain in short leg.

Chain Size	in.	mm	System	Oblong Master Link					Working Load Limit at 60°	
				Nominal Size Material		Inside Dimensions				
				in.	mm	Width	Length		lb	kg
9/32	7	10	37/64	15	2 1/2	64	5	127	7,400	3,400
3/8	10	10	13/16	21	3	76	6	152	15,200	6,900
1/2	13	10	1 1/8	29	4	102	8	203	26,000	11,800
5/8	16	10	1 1/4	32	4	102	8	203	39,100	17,700
3/4	20	10	1 5/8	41	5 1/4	133	10 1/2	267	61,100	27,700
7/8	22	10	1 7/8	48	6	152	12	305	74,000	33,500
1	26	8	2	51	7	178	14	356	82,600	37,900
1 1/4	32	8	2 1/4	57	8	203	16	406	125,200	56,800

For other angles of lift, refer to type "D" sling specifications. Dimensions are approximate. These items are made to order.

## Cam-Alloy Chain Slings Double Adjustable

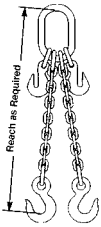

Style A



Style B

Standard with 1 foot of chain in short leg.

Chain Size	in.	mm	System	Oblong Master Link					Working Load Limit at 60°	
				Nominal Size Material		Inside Dimensions				
				in.	mm	Width	Length		lb	kg
9/32	7	10	37/64	15	2 1/2	64	5	127	7,400	3,400
3/8	10	10	13/16	21	3	76	6	152	15,200	6,900
1/2	13	10	1 1/8	29	4	102	8	203	26,000	11,800
5/8	16	10	1 1/4	32	4	102	8	203	39,100	17,700
3/4	20	10	1 5/8	41	5 1/4	133	10 1/2	267	61,100	27,700
7/8	22	10	1 7/8	48	6	152	12	305	74,000	33,500
1	26	8	2	51	7	178	14	356	82,600	37,900

For other angles of lift, refer to type "D" sling specifications. Dimensions are approximate. These items are made to order.

## Cam-Alloy Chain Slings Double Adjustable Loop

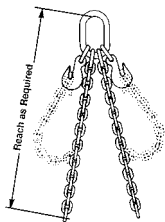

Style A

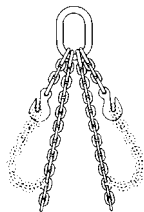

Style B

Standard with 1 foot of chain in short leg.

Chain Size	in.	mm	System	Oblong Master Link					Working Load Limit at 60°	
				Nominal Size Material		Inside Dimensions				
				in.	mm	Width	Length		lb	kg
9/32	7	10	13/16	21	3	76	6	152	11,200	5,100
3/8	10	10	1 1/8	29	4	102	8	203	22,800	10,300
1/2	13	10	1 1/4	32	4	102	8	203	39,000	17,700
5/8	16	10	1 5/8	41	5 1/4	133	10 1/2	267	58,700	26,600
3/4	20	10	1 7/8	48	6	152	12	305	91,700	41,600
7/8	22	10	2 1/4	57	8	203	16	406	110,900	50,250
1	26	8	2 1/4	57	8	203	16	406	123,900	56,900

For other angles of lift, refer to type "D" sling specifications. Dimensions are approximate. These items are made to order.



## Cam-Alloy Chain Sling Single and Double Basket

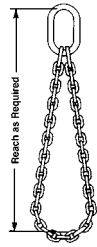

Single Basket

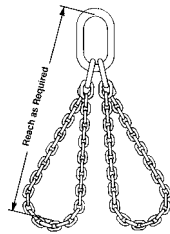

Double Basket

Chain Size	in.	mm	System	Oblong Master Link					Working Load Limit at 60°	
				Nominal Size Material		Inside Dimensions			lb	kg
				in.	mm	Width	Length			
9/32	7	10	37/64	15	2 1/2	64	5	127	7,400	3,400
3/8	10	10	13/16	21	3	76	6	152	15,200	6,900
1/2	13	10	1/8	29	4	102	8	203	26,000	11,800
5/8	16	10	1/4	32	4	102	8	203	39,100	17,700
3/4	20	10	5/8	41	5 1/4	133	10 1/2	267	61,100	27,700
7/8	22	10	1 7/8	48	6	152	12	305	74,000	33,500
1	26	8	2	51	7	178	14	356	82,600	37,900
1 1/4	32	8	2 1/4	57	8	203	16	406	125,200	56,800

Chain Size	in.	mm	System	Oblong Master Link					Working Load Limit at 60°	
				Nominal Size Material		Inside Dimensions			lb	kg
				in.	mm	Width	Length			
9/32	7	10	13/16	21	3	76	6	152	11,200	5,100
3/8	10	10	1/8	29	4	102	8	203	22,800	10,300
1/2	13	10	1/4	32	4	102	8	203	39,000	17,700
5/8	16	10	5/8	41	5 1/4	133	10 1/2	267	58,700	26,600
3/4	19	10	1 7/8	48	6	152	12	305	91,700	41,600
7/8	22	10	2 1/4	57	8	203	16	406	110,900	50,250
1	26	8	2 1/4	57	8	203	16	406	123,900	56,900

For other angles of lift, refer to Type "D" for single basket slings and Type "Q" for double basket slings. Dimensions are approximate. These items are made to order.

## Cam-Alloy Chain Sling Single and Double Endless Basket



Single Endless Basket

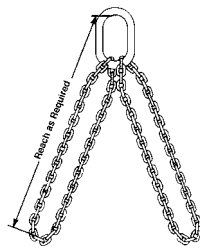

Double Endless Basket

Chain Size	in.	mm	System	Oblong Master Link					Working Load Limit at 60°	
				Nominal Size Material		Inside Dimensions			lb	kg
				in.	mm	Width	Length			
9/32	7	10	37/64	15	2 1/2	64	5	127	4,300	1,950
3/8	10	10	13/16	21	3	76	6	152	8,800	3,990
1/2	13	10	1/8	29	4	102	8	203	15,000	6,800
5/8	16	10	1/8	29	4	102	8	203	22,600	10,250
3/4	20	10	1/4	32	4	102	8	203	35,300	16,000
7/8	22	10	5/8	41	5 1/4	133	10 1/2	267	42,700	19,400
1	26	8	1 7/8	48	6	152	12	305	47,700	21,600
1 1/4	32	8	2	51	7	178	14	356	72,300	32,800

Chain Size	in.	mm	System	Oblong Master Link					Working Load Limit at 60°	
				Nominal Size Material		Inside Dimensions			lb	kg
				in.	mm	Width	Length			
9/32	7	10	13/16	21	3	76	6	152	15,200	6,900
3/8	10	10	1/8	29	4	102	8	203	26,000	11,800
1/2	13	10	1/4	32	4	102	8	203	39,100	17,700
5/8	16	10	5/8	41	5 1/4	133	10 1/2	267	61,100	27,700
3/4	20	10	1 7/8	48	6	152	12	305	74,000	33,500
7/8	22	10	2 1/4	57	8	203	16	406	125,200	56,800
1	26	8	2 1/4	57	8	203	16	406	125,200	56,800

For other angles of lift, refer to Type "D" for single basket slings and Type "Q" for double basket slings. Dimensions are approximate. These items are made to order.

### ⚠️ ADVERTENCIA

- Para prevenir la posibilidad de una lesión personal seria:
- **NO EXCEDA** los límites de carga de las cadenas o componentes.
  - **NO LA UTILICE** para cargar hacia arriba o para izar.
  - **NO LA UTILICE** si la cadena o los componentes están visualmente distorsionados o gastados.

### ⚠️ WARNING

- To prevent the possibility of serious bodily injury:
- **DO NOT EXCEED** the working load limits for chain or components.
  - **DO NOT USE** for overhead lifting or hoisting.
  - **DO NOT USE** if the chain or components are visibly distorted or worn.

## Cam-Alloy Chain Slings Double with Links Only

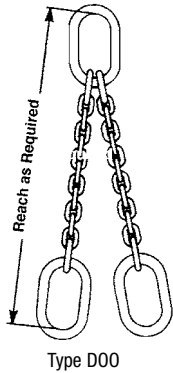

Chain Size	in.	mm	System	Oblong Master Link					Standard Oblong Link					Working Load Limit at 60°			
				Nominal Size Material		Inside Dimensions			Nominal Size Material		Inside Dimensions						
				in.	mm	Width	Length		in.	mm	Width	Length					
9/32	7	10	10	37/64	15	2 1/2	64	5	127	37/64	15	2 1/2	64	5	127	7,400	3,400
3/8	10	10	10	13/16	21	3	76	6	152	13/16	21	3	76	6	152	15,200	6,900
1/2	13	10	10	1 1/8	29	4	102	8	203	1 1/8	29	4	102	8	203	26,000	11,800
5/8	16	10	10	1 1/4	32	4	102	8	203	1 1/8	29	4	102	8	203	39,100	17,700
3/4	20	10	10	1 5/8	41	5 1/4	133	10 1/2	267	1 1/4	32	4	102	8	203	61,100	27,700
7/8	22	10	10	1 7/8	48	6	152	12	305	1 1/2	38	5 1/4	133	10 1/2	267	74,000	33,500
1	26	8	8	2	51	7	178	14	356	1 3/4	44	6	152	12	305	82,600	37,900
1 1/4	32	8	8	2 1/4	57	8	203	16	406	2	51	7	178	14	356	125,200	56,800

Dimensions and weights are approximate. For other angles of lift, refer to Type "D" slings. These items are made to order.

## Cam-Alloy Chain Shortener

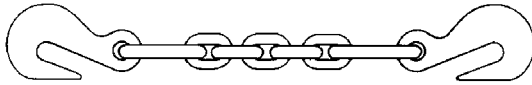

Chain Size		System	Reach	Working Load Limit	
in.	mm			lb	kg
9/32	7	10	1'1"	4,300	1,950
3/8	10	10	1'3"	8,800	4,000
1/2	13	10	1'8"	15,000	6,800
5/8	16	10	2'0"	22,600	10,300
3/4	20	10	2'4"	35,300	16,000
7/8	22	10	2'8"	42,700	19,400
1	26	8	3'1"	47,700	21,600
1 1/4	32	8	3'10"	72,300	32,800

Dimensions are approximate. These items are made to order.

## Cam-Alloy Chain Slings Attachment, One End Only

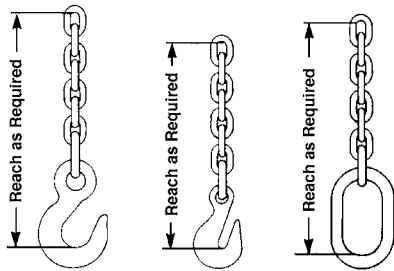

Chain Size		System	Working Load Limit	
in.	mm		lb	kg
9/32	7	10	4,300	1,950
3/8	10	10	8,800	4,000
1/2	13	10	15,000	6,800
5/8	16	10	22,600	10,300
3/4	20	10	35,300	16,000
7/8	22	10	42,700	19,400
1	26	8	47,700	21,600
1 1/4	32	8	72,300	32,800

Dimensions are approximate. These items are made to order.

## How Off-Center (Tip) Loading Reduces Working Load Limits of 1/2" - Cam-Alloy Sling Hooks

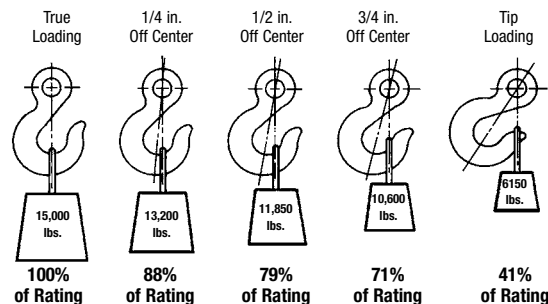



## Cam-Alloy Sling Hooks

- For Use with Grade 80/100 Chain Slings
- 4 to 1 Design Factor
- Meet or Exceed All Requirements of ASME B30.9 and B30.10
- 100% Proof Tested in Accordance with ASTM A952
- Additionally Hallmarked with "USA" and Date Code
- Made in the USA
- DO NOT EXCEED THE WORKING LOAD LIMIT

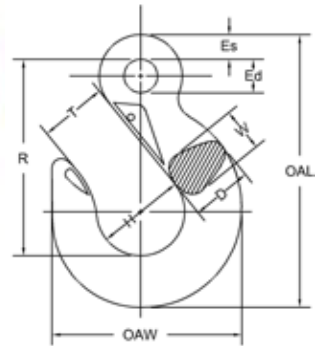

Chain Size	Catalog No.	UPC No. 020418	Hook No.	Grade	Working Load Limit	Weight Each	Shelf Pack
9/32 in	5646415	222320	C-80	100	4300 lb	1.30 lb	25
3/8 in	5646615	221583	C-81	100	8800 lb	2.10 lb	10
1/2 in	5646815	222856	C-82	100	15000 lb	5.42 lb	-
5/8 in	5647015	225109	C-83	100	22600 lb	10.00 lb	-
3/4 in	5647215	225093	C-84	100	35300 lb	15.10 lb	-
7/8 in	5645415	152962	C-85	100	42700 lb	21.00 lb	-
1 in	5641615	078859	C-86	80	47700 lb	21.98 lb	-

Chain Size	Catalog No.	D Dim.	Ed Dim.	Es Dim.	H Dim.	OAL	OAW	R Dim.	T Dim.	W Dim.
9/32 in	5646415	1.14 in	0.75 in	0.44 in	1.50 in	5.56 in	3.59 in	4.50 in	1.25 in	0.75 in
3/8 in	5646615	1.46 in	0.813 in	0.594 in	2.13 in	6.59 in	4.50 in	4.75 in	1.62 in	1.05 in
1/2 in	5646815	2 in	1.13 in	0.804 in	2.25 in	8.37 in	5.65 in	5.70 in	1.88 in	1.42 in
5/8 in	5647015	2.42 in	1.31 in	0.875 in	2.62 in	10.47 in	6.67 in	7.47 in	2.34 in	1.54 in
3/4 in	5647215	2.91 in	1.50 in	1.00 in	3.00 in	11.59 in	7.77 in	8.00 in	2.53 in	1.83 in
7/8 in	5645415	2.88 in	2.00 in	1.12 in	3.75 in	13.38 in	8.75 in	9.75 in	3.18 in	1.88 in
1 in	5641615	3.50 in	1.94 in	1.38 in	4.25 in	14.56 in	9.59 in	10.18 in	3.25 in	2.38 in

## Cam-Alloy Sling Hooks with Latches

- For Use with Grade 80/100 Chain Slings
- 4 to 1 Design Factor
- Meet or Exceed All Requirements of ASME B30.9 and B30.10
- 100% Proof Tested in Accordance with ASTM A952
- Additionally Hallmarked with "USA" and Date Code
- Integrated Latch Engages Tip of Hook
- Made in the USA
- DO NOT EXCEED THE WORKING LOAD LIMIT

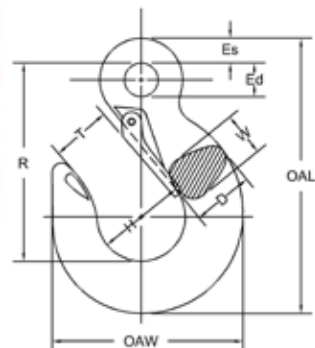

Chain Size	Catalog No.	UPC No. 020418	Hook No.	Grade	Working Load Limit	Weight Each	Shelf Pack
9/32 in	5646495	222313	C-90	100	4300 lb	1.24 lb	20
3/8 in	5646695	221590	C-91	100	8800 lb	2.20 lb	10
1/2 in	5646895	222870	C-92	100	15000 lb	5.57 lb	-

Chain Size	Catalog No.	D Dim.	Ed Dim.	Es Dim.	H Dim.	OAL	OAW	R Dim.	T Dim.	W Dim.
9/32 in	5646495	1.14 in	0.75 in	0.44 in	1.50 in	5.56 in	3.59 in	4.50 in	0.875 in	0.75 in
3/8 in	5646695	1.46 in	0.813 in	0.594 in	2.13 in	6.59 in	4.50 in	4.75 in	1.314 in	1.05 in
1/2 in	5646895	2.00 in	1.13 in	0.804 in	2.25 in	8.37 in	5.65 in	5.70 in	1.50 in	1.42 in

## Sling Hook Replacement Latches (New Style)



- Replacement Latches for Cam-Alloy & Quik-Alloy Sling Hooks
- New Latch Design Fits Newer Integrated Tip Sling Hooks

Chain Size	Catalog No.	UPC No. 020418	Cam-Alloy Sling Hook	Cam-Alloy Sling Hook with Latch	Quik-Alloy Sling Hook	Quik-Alloy Sling Hook with Latch	Latch Marking	Weight Each
9/32 in	7506495	223853	5646415	5646495	5746415	5746495	CC-4	0.08 lb
3/8 in	7506695	223846	5646615	5646695	5746615	5746695	CC-5	0.08 lb
1/2 in	7506895	225161	5646815	5646895	5746815	5746895	CC-7	0.14 lb
5/8 in	7507095	225178	5647015	-	5747015	5747095	CC-8	0.18 lb
3/4 in	7507295	225154	5647215	-	5747215	5747295	CC-9	0.52 lb



## Cam-Alloy and Quik-Alloy Latches (Old Style)

- Replacement Latches for Older Cam-Alloy® and Quik-Alloy® Sling Hooks
- Clapper Latch Design Fits Older Style Non-Integrated Tip Sling Hooks

Chain Size	Catalog No.	UPC No. 020418	Cam-Alloy Sling Hook	Cam-Alloy Sling Hook with Latch	Quik-Alloy Sling Hook	Quik-Alloy Sling Hook with Latch
9/32 in	3990401	072758	5644415	5644495	5744415	5744495
3/8 in	3990601	072772	5644615	5644695	5744615	5744695
1/2 in	3990701	072789	5644815	5644895	5744815	5744895
5/8 in & 3/4 in	3991001	072819	5645015 & 5645215	5645095 & 5645295	5745015 & 5745215	5745095 & 5745295
7/8 in & 1 in	3991409	177163	5645415 & 5641615	5645495 & 5641695	-	-



## Cam-Alloy Foundry Hooks

- For Use with Grade 80/100 Chain Slings
- 4 to 1 Design Factor
- Meet or Exceed All Requirements of ASME B30.9 and B30.10
- 100% Proof Tested in Accordance with ASTM A952
- Additionally Hallmarked with "USA" and Date Code
- Made in the USA
- DO NOT EXCEED THE WORKING LOAD LIMIT

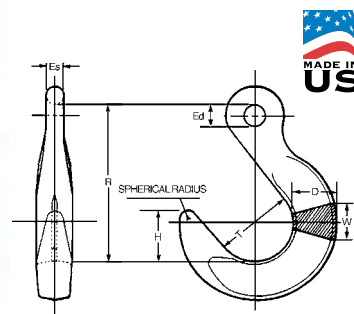

Chain Size	Catalog No.	UPC No. 020418	Hook No.	Grade	Working Load Limit	Weight Each	D Dim.	Ed Dim.	Es Dim.	H Dim.	R Dim.	T Dim.	W Dim.	Spherical Radius
9/32 in	5664415	182457	C-498	100	4300 lb	2.20 lb	1.3 in	0.62 in	0.47 in	1.56 in	4.75 in	2.50 in	1.00 in	0.25 in
3/8 in	5664615	182464	C-499	100	8800 lb	3.90 lb	1.56 in	0.75 in	0.62 in	1.87 in	5.75 in	3.00 in	1.25 in	0.31 in
1/2 in	5664815	182471	C-500	100	15000 lb	6.70 lb	1.81 in	1.00 in	0.75 in	2.25 in	6.87 in	3.50 in	1.50 in	0.37 in
5/8 in	5665015	182488	C-501	100	22600 lb	10.50 lb	2.33 in	1.25 in	0.87 in	2.62 in	8.06 in	4.00 in	1.75 in	0.44 in
3/4 in	5665215	182495	C-502	100	35300 lb	15.60 lb	2.81 in	1.50 in	1.00 in	3.00 in	9.25 in	4.50 in	2.00 in	0.50 in
7/8 in	5665415	152948	C-503	100	42700 lb	24.00 lb	3.08 in	1.84 in	1.12 in	3.37 in	10.37 in	5.00 in	2.25 in	0.56 in
1 in	5661615	078965	C-504	80	47700 lb	34.10 lb	3.25 in	2.09 in	1.25 in	3.75 in	11.56 in	5.50 in	2.50 in	0.62 in
1-1/4 in	5662015	078972	C-505	80	72300 lb	52.50 lb	3.88 in	2.47 in	1.37 in	4.25 in	12.87 in	6.00 in	3.00 in	0.75 in





## Cam-Alloy Grab Hooks

- For Use with Grade 80/100 Chain Slings
- 4 to 1 Design Factor
- Meet or Exceed All Requirements of ASME B30.9 and B30.10
- 100% Proof Tested in Accordance with ASTM A952
- Additionally Hallmarked with "USA" and Date Code
- Made in the USA
- Note: Use of Chain in a Grab Hook May Reduce the Design Factor of the Chain by up to 20%
- DO NOT EXCEED THE WORKING LOAD LIMIT

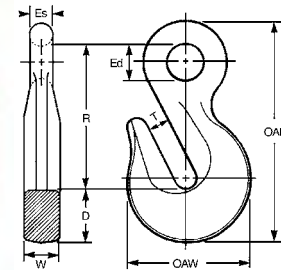

Chain Size	Catalog No.	UPC No. 020418	Hook No.	Grade	Working Load Limit	Weight Each	Shelf Pack	D Dim.	Ed Dim.	Es Dim.	OAL	OAW	R Dim.	T Dim.	W Dim.
9/32 in	5624415	182303	C-72	100	4300 lb	0.60 lb	50	0.81 in	0.56 in	0.37 in	3.69 in	1.87 in	2.50 in	0.37 in	0.59 in
3/8 in	5624615	182310	C-73	100	8800 lb	0.90 lb	30	1.16 in	0.75 in	0.44 in	4.00 in	2.56 in	2.41 in	0.50 in	0.66 in
1/2 in	5624815	182327	C-75	100	15000 lb	2.80 lb	20	1.44 in	1.12 in	0.56 in	5.40 in	3.50 in	3.40 in	0.66 in	0.88 in
5/8 in	5625015	182334	C-76	100	22600 lb	3.70 lb	-	1.75 in	1.22 in	0.69 in	6.66 in	4.25 in	4.22 in	0.78 in	1.12 in
3/4 in	5625215	182341	C-77	100	35300 lb	7.50 lb	-	2.12 in	1.44 in	1.00 in	8.28 in	5.18 in	5.15 in	0.94 in	1.38 in
7/8 in	5625415	152979	C-78	100	42700 lb	11.20 lb	-	2.44 in	1.75 in	1.00 in	10.44 in	5.68 in	7.00 in	1.06 in	1.62 in
1 in	5621615	078651	C-79	80	47700 lb	18.50 lb	-	3.00 in	1.87 in	1.12 in	12.14 in	6.75 in	7.98 in	1.19 in	1.81 in

## Self-locking Eye Hooks

- Meet or Exceed All Requirements of ASME B30.9 and B30.10
- Fatigue and 100% Proof Tested in Accordance with ASTM A952
- Additionally Hallmarked with "USA" and Date Code
- Meets the Intent of OSHA Regulation 1926.550(g)(4)(iv)(b)
- Latch Closes Automatically Under Load
- Eye Style is Designed to Accommodate Heavy Duty Wire Rope Thimbles
- Stamped with Recommended Wire Rope Size
- Working Load Limit Rating of 5 to 1 to Meet Design Requirements of Wire Rope Slings
- Made in the USA
- DO NOT EXCEED THE WORKING LOAD LIMIT

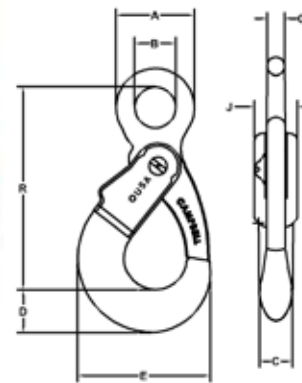

Chain Size	Catalog No.	UPC No. 020418	Working Load Limit 4 to 1	For Wire Rope Size	Working Load Limit 5 to 1	Weight Each	Shelf Pack
9/32 in	5648495	193262	4300 lb	7/16 in	3800 lb	2.25 lb	-
3/8 in	5648695	193279	8800 lb	1/2 in	7000 lb	4.00 lb	-
1/2 in	5648895	193286	15000 lb	5/8 in	12000 lb	8.65 lb	1
5/8 in	5649095	193293	22600 lb	7/8 in	18000 lb	13.80 lb	1

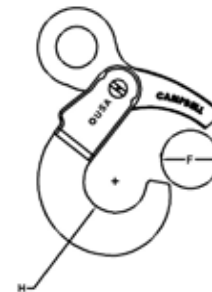

Chain Size	Catalog No.	A Dim.	B Dim.	C Dim.	D Dim.	E Dim.	F Dim.	G Dim.	H Dim.	J Dim.	R Dim.
9/32 in	5648495	1.875 in	1.00 in	0.938 in	1.02 in	3.594 in	1.625 in	0.438 in	0.875 in	1.25 in	5.468 in
3/8 in	5648695	2.375 in	1.375 in	1.125 in	1.250 in	4.312 in	1.875 in	0.578 in	1.063 in	1.50 in	6.50 in
1/2 in	5648895	3.188 in	1.688 in	1.312 in	1.796 in	5.404 in	2.250 in	0.688 in	1.281 in	1.75 in	8.75 in
5/8 in	5649095	3.50 in	2.00 in	1.50 in	2.169 in	6.50 in	2.375 in	0.75 in	1.50 in	2.00 in	10.00 in



## Self-Locking Swivel Hooks

- Meet or Exceed All Requirements of ASME B30.9 and B30.10
- Fatigue and 100% Proof Tested in Accordance with ASTM A952
- Additionally Hallmarked with "USA" and Date Code
- Meets the Intent of OSHA Regulation 1926.550(g)(4)(iv)(b)
- Latch Closes Automatically Under Load
- Working Load Limit Rating of 5 to 1 to Meet Design Requirements of Wire Rope Slings
- Made in the USA
- DO NOT EXCEED THE WORKING LOAD LIMIT
- HOOK IS NOT DESIGNED TO SWIVEL UNDER LOAD

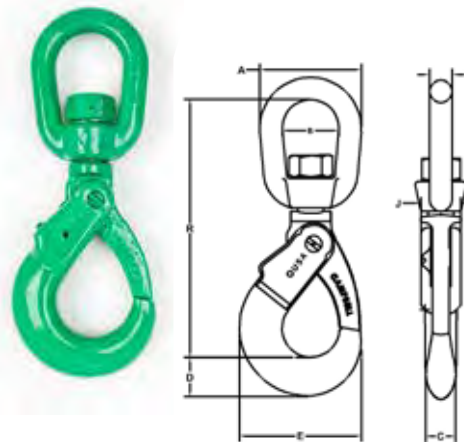

Chain Size	Catalog No.	UPC No. 020418	Working Load Limit 4 to 1	For Wire Rope Size	Working Load Limit 5 to 1	Weight Each
9/32 in	5798495	226830	4300 lb	7/16 in	3800 lb	3.35 lb
3/8 in	5798695	226847	8800 lb	1/2 in	7000 lb	5.80 lb
1/2 in	5798895	226878	15000 lb	5/8 in	12000 lb	12.95 lb
5/8 in	5799095	226861	22600 lb	7/8 in	18000 lb	21.00 lb

Chain Size	Catalog No.	A Dim.	B Dim.	C Dim.	D Dim.	E Dim.	F Dim.	G Dim.	H Dim.	J Dim.	R Dim.
9/32 in	5798495	3.00 in	1.75 in	0.938 in	1.02 in	3.594 in	1.625 in	0.625 in	0.875 in	1.25 in	7.688 in
3/8 in	5798695	3.50 in	2.00 in	1.125 in	1.25 in	4.312 in	1.875 in	0.75 in	1.063 in	1.50 in	8.813 in
1/2 in	5798895	4.50 in	2.50 in	1.312 in	1.796 in	5.404 in	2.25 in	1.00 in	1.281 in	1.75 in	11.25 in
5/8 in	5799095	5.625 in	3.50 in	1.50 in	2.169 in	6.50 in	2.375 in	1.25 in	1.50 in	2.00 in	13.438 in

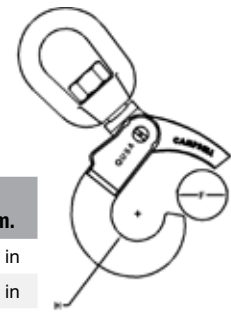

## Cam-Alloy Oblong Master Links

- For Use with Grade 80/100 Chain Slings, Wire Rope and Synthetic Assemblies
- 5 to 1 Design Factor
- Meet or Exceed All Requirements of ASME B30.26
- 100% Proof Tested in Accordance with ASTM A952
- Hallmarked with "USA", Date Code, Link No. and Material Diameter
- Made in the USA
- DO NOT EXCEED THE WORKING LOAD LIMIT



Link No.	Cat. No.	Material Diameter (A)	Inside Width (B)	Inside Length (C)	Working Load Limit 5 to 1	Used with Single Type S & C	Used with Double Type D	Used with Triple or Quad Type T or Q
CO-0	5685615	13/32 in	1.50 in	3.00 in	4200 lb	7/32 in	7/32 in	-
CO-1	5683215	5/8 in	2.50 in	5.00 in	8600 lb	9/32 in	9/32 in	7/32 in
CO-2	5683315	13/16 in	3.00 in	6.00 in	17600 lb	3/8 in	3/8 in	9/32 in
CO-3	5683415	1-1/8 in	4.00 in	8.00 in	30000 lb	1/2 in or 5/8 in	1/2 in	3/8 in
CO-4	5683515	1-1/4 in	4.00 in	8.00 in	45200 lb	3/4 in	5/8 in	1/2 in
CO-5	5683615	1-5/8 in	5.25 in	10.50 in	70600 lb	7/8 in	3/4 in	5/8 in
CO-6	5683715	1-7/8 in	6.00 in	12.00 in	105900 lb	1 in	7/8 in	3/4 in
CO-7	5687015	2 in	7.00 in	14.00 in	102600 lb	1-1/4 in or 1-1/2 in	1 in	-
CO-8	5687215	2-1/4 in	8.00 in	16.00 in	144600 lb	-	1-1/4 in or 1-1/2 in	7/8 in or 1 in

SLINGS



## Cam-Alloy Wide Oblong Master Links



- Wider Than Standard Master Links
- Usable with Quik-Alloy® Coupling Links for Double Leg Slings
- Wider Link Accommodates Heavy Wire Rope Thimbles in Multiple Leg Slings
- Grade 100 Chain Strength
- 5 to 1 Design Factor
- Meet or Exceed All Requirements of ASME B30.26
- 100% Proof Tested in Accordance with ASTM A952
- Hallmarked with “USA”, Date Code, Link No. and Material Diameter
- Made in the USA
- DO NOT EXCEED THE WORKING LOAD LIMIT

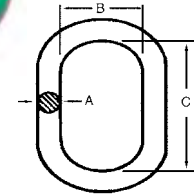

Link No.	Catalog No.	Material Dia. (A)	Inside Width (B)	Inside Length (C)	Working Load Limit 5 to 1	Shelf Pack
CW-2	5683315VW	7/8 in	4.00 in	6.50 in	17600 lb	1
CW-3	5683415VW	1-1/8 in	4.25 in	7.50 in	30000 lb	1
CW-4	5683515VW	1-3/8 in	5.50 in	9.50 in	45200 lb	1
CW-5	5683615VW	1-5/8 in	5.875 in	10.50 in	70600 lb	1

## Cam-Alloy Oblong, Master Link Sub-Assemblies



- For Construction of Triple, Quad and Double Basket Slings
- 5 to 1 Design Factor
- Meet or Exceed All Requirements of ASME B30.26
- 100% Proof Tested in Accordance with ASTM A952
- Master Link Hallmarked with “USA”, Date Code, Link No. and Material Diameter
- Made in the USA
- DO NOT EXCEED THE WORKING LOAD LIMIT

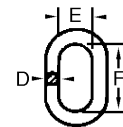
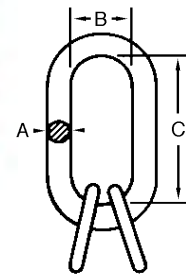

Chain Size	Catalog No.	UPC No. 020418	Working Load Limit 5 to 1	Weight Each	Oblong Master Link Material Dia. (A)	Oblong Master Link Inside Width (B)
9/32 in	5682215	182501	12900 lb	4.40 lb	13/16 in	3 in
3/8 in	5682315	182846	26400 lb	9.50 lb	1-1/8 in	4 in
1/2 in	5682415	182518	45000 lb	16.00 lb	1-1/4 in	4 in
5/8 in	5682515	182525	67800 lb	31.75 lb	1-5/8 in	5-1/4 in
3/4 in	5682615	182532	105900 lb	50.00 lb	1-7/8 in	6 in
7/8 in	5682715	167409	128100 lb	85.00 lb	2-1/4 in	8 in

Chain Size	Catalog No.	Oblong Master Link Inside Length (C)	Master Coupling Link Material Dia. (D)	Master Coupling Link Inside Width (E)	Master Coupling Link Inside Length (F)
9/32 in	5682215	6 in	17/32 in	1-1/2 in	2-3/4 in
3/8 in	5682315	8 in	25/32 in	1-9/16 in	2-7/8 in
1/2 in	5682415	8 in	1 in	3 in	5 in
5/8 in	5682515	10-1/2 in	1-1/4 in	4 in	6 in
3/4 in	5682615	12 in	1-1/2 in	4 in	6 in
7/8 in	5682715	16 in	1-3/4 in	4 in	6 in

## Quik-Alloy Chain Slings

The Campbell Quik-Alloy system provides proof tested and certified components for easily and quickly assembling all of the popular types of chain slings plus many special slings.

Hooks and coupling links have rotating load pins that resist bending and offer shear values equivalent to the chain. The open design of the hooks allows for easy inspection. All Quik-Alloy components are sized and identified according to the chain with which they are to be used. They meet or exceed all OSHA, ANSI, and ASME specifications.

## How to Design Quik-Alloy Chain Slings

1. Determine the maximum LOAD to be lifted.
2. Choose the TYPE of sling assembly necessitated by the size and dimension of the load.
3. Estimate the approximate ANGLE to the load in which the legs of the assembly will be positioned for operation.
4. Determine the SIZE OF CHAIN ATTACHMENTS by referring to the Assembly Tables that follow. On multi-leg slings, if the distance between the points of attachment equals the reach of the sling, the angle is approximately 60°
5. Determine the overall REACH (see illustration). Use the Assembly Tables that follow to determine length of Cam-Alloy chain to order.
6. Attach field identification tag to all slings.  
One box of 50 - No. 7503506.

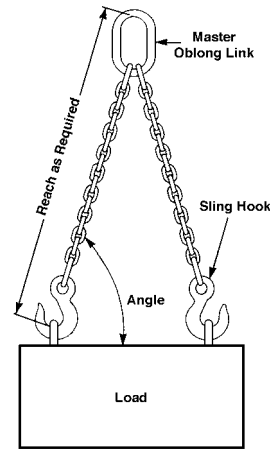

For any problem involving reach, angle of lift or working load limit, consult your local Campbell distributor. Remember to use only Campbell “Quik-Alloy” components in assembling chain slings.

SUBSTITUTION OF ANY COMPONENTS WITH PARTS NOT INDICATED ON THE CHART COULD SERIOUSLY DIMINISH THE WORKING LOAD OF THE ASSEMBLY. Do not use any coupling links to repair damaged or broken chain. It is imperative that such chain be replaced.

## How to Assemble Quik-Alloy Coupling Links

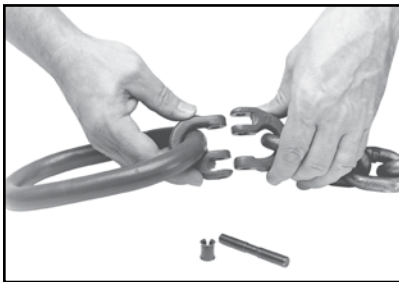

1. Loop one half of body over the master link at the flat embossed area, the other half through the chain. Fit together.



2. Place stud assembly and alloy locking pin in link as shown.



3. Drive the locking pin in until the snap ring engages the recessed portion of the pin. (Link is disassembled by simply driving locking pin out.)



# How to Use Quik-Alloy Chain Sling Assembly Tables

If the overall reach of your sling is determined to be more than five feet, subtract five feet, then add this difference to the “chain needed” length on the Assembly Table. If overall reach is less than five feet, subtract reach from five feet. Then subtract the difference from the “chain needed” length in the Assembly Table. All measurements are based on using Quik-Alloy hooks (not Cam-Alloy).

WHEN USING QUIK-ALLOY HOOKS (NOT CAM-ALLOY HOOKS), BE SURE THAT EACH LEG OF A DOUBLE SLING HAS THE SAME, EVEN (DIVISIBLE BY TWO) NUMBER OF LINKS. For triple or quad slings, each leg should have odd numbers of links to compensate for coupling links on master link sub-assembly. When cutting, if the required reach falls within a link, LEAVE THAT LINK. Reach measurements are given as a minimum. Never cut less than specified reach.

## Quik-Alloy Chain Sling Assembly Tables

Chain Size	9/32	7	3/8	10	1/2	13	5/8	16	3/4	19
------------	------	---	-----	----	-----	----	-----	----	-----	----

### Single Chain Slings: Types S and C



Working Load Limit	lb	kg	lb	kg	lb	kg	lb	kg	lb	kg
4,300	3,405	1,952	8,800	3,995	15,000	6,810	22,600	10,260	35,300	16,026
Master Link Number	CO-1		CO-2		CO-3		CO-3		CO-4	
Cat.No.	5683215		5683315		5683415		5683515		5683615	
	5746415		5746615		5746815		5747015		5747015	
	5724415		5724615		5724815		5725015		5725215	
	5726415		5726615		5726815		5727015			
	5779225		5779235		5779245		5779255		5779165	
Chain needed for 5' reach	4'1"		3'10"		3'7"		3'5"		3'3"	
	4'3"		4'0"		3'9"		3'8"		3'6"	

### Double Chain Slings: Type D

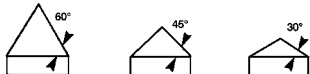

Working Load Limit	lb	kg	lb	kg	lb	kg	lb	kg	lb	kg
60°	7,500	3,405	15,200	6,901	26,000	7,704	39,100	17,751	61,100	27,739
45°	6,100	2,769	12,400	5,630	21,200	9,625	32,000	14,528	49,900	22,655
30°	4,300	1,952	8,800	3,995	15,000	6,810	22,600	10,260	35,300	16,026
Master Link Number	CO-1		CO-2		CO-3		CO-4		CO-5	
Cat.No.	5683215		5683315		5683415		5683515		5683615	
	5746415		5746615		5746815		5747015		5747015	
	5724415		5724615		5724815		5725015		5725215	
	5726415		5726615		5726815		5727015			
	5779225		5779235		5779245		5779255		5779165	
Chain needed for 5' reach	4'1"		3'10"		3'7"		3'5"		3'1"	
	4'3"		4'0"		3'9"		3'8"		3'3"	

### Triple Chain Slings: Type T and Quad Chain Slings: Type Q

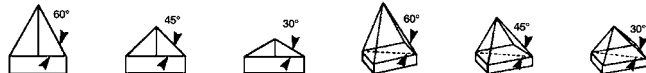

Working Load Limit	lb	kg	lb	kg	lb	kg	lb	kg	lb	kg
60°	11,200	5,085	22,800	10,351	39,000	17,706	58,700	26,650	91,700	41,632
45°	9,100	4,131	18,600	8,444	31,800	14,437	47,900	21,747	74,900	34,005
30°	6,450	2,928	13,200	5,993	22,500	10,215	33,900	15,391	53,000	24,062
Master Link Number	CO-2		CO-3		CO-4		CO-5		CO-6	
Cat.No.	5682215		5682315		5682415		5682515		5682615	
	5746415		5746615		5746815		5747015		5747015	
	5724415		5724615		5724815		5725015		5725215	
	5726415		5726615		5726815		5727015			
	5779225		5779235		5779245		5779255		5779165	
Chain needed for 5' reach	3'10"		3'6"		3'2"		2'10"		2'5"	
	3'11"		3'8"		3'4"		2'10"		2'8"	

SLINGS



## Quik-Alloy Coupling Links

- For Connecting Chain to Components in the Fabrication of Chain Slings
- For Use with Grade 80/100 Chain Slings
- 4 to 1 Design Factor
- Meet or Exceed All Requirements of ASME B30.9
- 100% Proof Tested in Accordance with ASTM A952
- 3/4" Through 1-1/4" Coupling Links Utilize A Barrel Style Oversized Retainer
- Made in the USA
- Per ASME B30.9, Section 9.1.3 "Mechanical Coupling Links Shall Not Be Used Within the Body of An Alloy Chain Sling to Connect Two Pieces of Chain"
- DO NOT EXCEED THE WORKING LOAD LIMIT

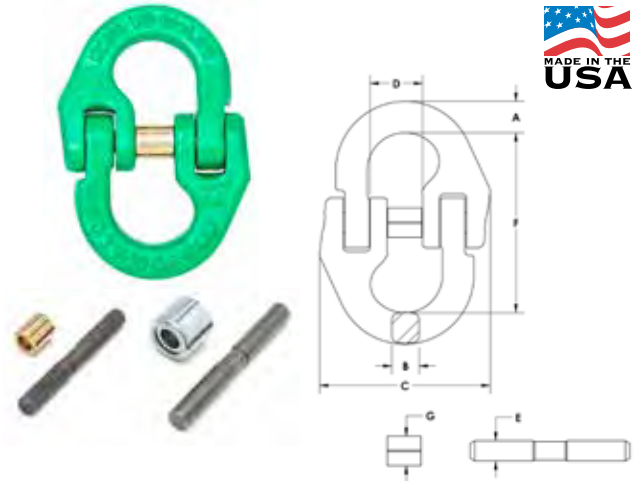

Chain Size	Catalog No.	UPC No. 020418	Grade	Material Diameter	Working Load Limit	Weight Each	Shelf Pack	A Dim.	B Dim.	C Dim.	D Dim.	E Dim.	F Dim.	G Dim.
7/32 in	5770315	079993	80	1/2 in	2100 lb	0.10 lb	1	17/64 in	7/32 in	15/16 in	7/16 in	5/32 in	1-17/32 in	3/8 in
9/32 in	5779225	288890	100	37/64 in	4300 lb	0.26 lb	-	3/8 in	11/32 in	23/32 in	9/16 in	13/64 in	2-13/64 in	5/16 in
3/8 in	5779235	288623	100	13/16 in	8800 lb	0.69 lb	-	1/2 in	7/16 in	2-3/8 in	13/16 in	5/16 in	2-3/4 in	7/16 in
1/2 in	5779245	288913	100	1-3/16 in	15000 lb	1.56 lb	-	11/16 in	9/16 in	3 in	1-1/32 in	25/64 in	3-3/8 in	5/8 in
5/8 in	5779255	288937	100	1-5/16 in	22600 lb	2.51 lb	-	13/16 in	23/32 in	3-7/8 in	1-9/32 in	15/32 in	4-1/8 in	11/16 in
3/4 in	5779165	182785	100	1-11/16 in	35300 lb	4.05 lb	-	15/16 in	61/64 in	4-5/8 in	1-9/16 in	9/16 in	4-3/4 in	-
7/8 in	5779175	152931	100	1-7/8 in	42700 lb	8.00 lb	-	1-3/16 in	1-1/16 in	5-3/8 in	1-13/16 in	41/64 in	5-5/16 in	-
1 in	5771615	080067	80	2-1/8 in	47700 lb	9.50 lb	-	1-15/64 in	1-9/64 in	5-7/8 in	2-1/32 in	11/16 in	5-7/8 in	-
1-1/4 in	5772015	080074	80	2-11/32 in	72300 lb	16.62 lb	-	1-1/2 in	1-3/8 in	7-3/8 in	2-9/32 in	15/16 in	6-15/16 in	-

## Quik-Alloy Coupling Link Pins and Retainers

- Replacement Pins and Retainers for Quik-Alloy Coupling Links



Chain Size	Catalog No.	UPC No. 020418	Grade	Weight Each	Shelf Pack
9/32 in	5785425	288906	100	0.02 lb	10
3/8 in	5785435	288630	100	0.06 lb	10
1/2 in	5785445	288920	100	0.11 lb	10
5/8 in	5785455	288944	100	0.17 lb	5
3/4 in	5784465	182839	100	0.35 lb	5
7/8 in	5784165	181740	100	0.58 lb	-





## Quik-Alloy Sling Hooks, Regular

- For Use with Grade 80/100 Chain Slings
- 4 to 1 Design Factor
- Meet or Exceed All Requirements of ASME B30.9 and B30.10
- 100% Proof Tested in Accordance with ASTM A952
- Additionally Hallmarked with "USA" and Date Code
- Made in the USA
- DO NOT EXCEED THE WORKING LOAD LIMIT

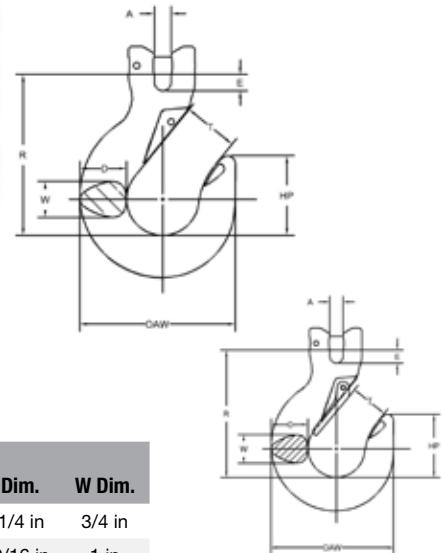

Chain Size	Catalog No.	UPC No. 020418	Grade	Working Load Limit	Weight Each	Shelf Pack
9/32 in	5746415	222344	100	4300 lb	1.50 lb	20
3/8 in	5746615	221606	100	8800 lb	3.10 lb	10
1/2 in	5746815	222863	100	15000 lb	6.45 lb	-
5/8 in	5747015	225123	100	22600 lb	10.20 lb	-
3/4 in	5747215	225147	100	35300 lb	17.60 lb	-

Chain Size	Catalog No.	A Dim.	D Dim.	E Dim.	Load Pin Diameter	HP	OAW	R Dim.	T Dim.	W Dim.
9/32 in	5746415	5/16 in	1-1/8 in	11/32 in	3/8 in	1.78 in	3-7/8 in	3-3/4 in	1-1/4 in	3/4 in
3/8 in	5746615	7/16 in	1-7/16 in	1/2 in	1/2 in	2-3/8 in	4-1/2 in	4-3/4 in	1-9/16 in	1 in
1/2 in	5746815	9/16 in	2 in	5/8 in	5/8 in	3 in	6 in	5-3/4 in	1-7/8 in	1-3/8 in
5/8 in	5747015	23/32 in	2-3/8 in	3/4 in	3/4 in	3 in	6-9/16 in	7 in	2-3/8 in	1-1/2 in
3/4 in	5747215	13/16 in	2-7/8 in	7/8 in	15/16 in	3-3/8 in	7-3/4 in	7-3/4 in	2-1/2 in	1-3/4 in

## Quik-Alloy Sling Hooks, Latched

- For Use with Grade 80/100 Chain Slings
- 4 to 1 Design Factor
- Meet or Exceed All Requirements of ASME B30.9 and B30.10
- 100% Proof Tested in Accordance with ASTM A952
- Additionally Hallmarked with "USA" and Date Code
- Made in the USA
- DO NOT EXCEED THE WORKING LOAD LIMIT

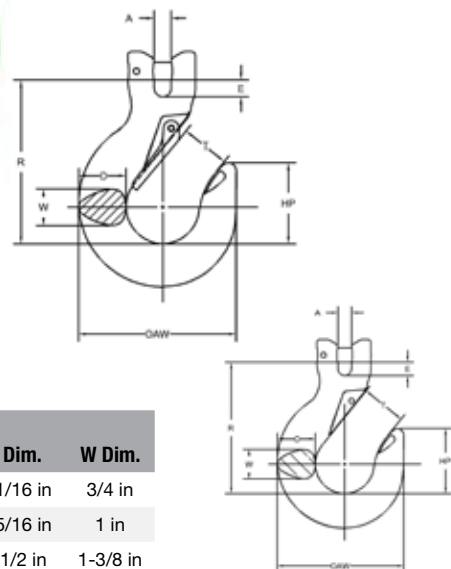

Chain Size	Catalog No.	UPC No. 020418	Grade	Working Load Limit	Weight Each	Shelf Pack
9/32 in	5746495	222337	100	4300 lb	1.60 lb	20
3/8 in	5746695	221576	100	8800 lb	3.10 lb	10
1/2 in	5746895	222849	100	15000 lb	6.60 lb	-
5/8 in	5747095	225130	100	22600 lb	10.50 lb	-
3/4 in	5747295	225116	100	35300 lb	18.00 lb	-

Chain Size	Catalog No.	A Dim.	D Dim.	E Dim.	Load Pin Dia.	HP	OAW	R Dim.	T Dim.	W Dim.
9/32 in	5746495	5/16 in	1-1/8 in	11/32 in	3/8 in	1.78 in	3-7/8 in	3-3/4 in	1-1/16 in	3/4 in
3/8 in	5746695	7/16 in	1-7/16 in	1/2 in	1/2 in	2-3/8 in	4-1/2 in	4-3/4 in	1-5/16 in	1 in
1/2 in	5746895	9/16 in	2 in	5/8 in	5/8 in	3 in	6 in	5-3/4 in	1-1/2 in	1-3/8 in
5/8 in	5747095	23/32 in	2-3/8 in	3/4 in	3/4 in	3 in	6-9/16 in	7 in	1-3/4 in	1-1/2 in
3/4 in	5747295	13/16 in	2-7/8 in	7/8 in	15/16 in	3-3/8 in	7-3/4 in	7-3/4 in	2-3/16 in	1-3/4 in



## Quik-Alloy Grab Hooks

- For Use with Grade 80/100 Chain Slings
- 4 to 1 Design Factor
- Meet or Exceed All Requirements of ASME B30.9 and B30.10
- 100% Proof Tested in Accordance with ASTM A952
- Additionally Hallmarked with "USA" and Date Code
- Made in the USA
- DO NOT EXCEED THE WORKING LOAD LIMIT

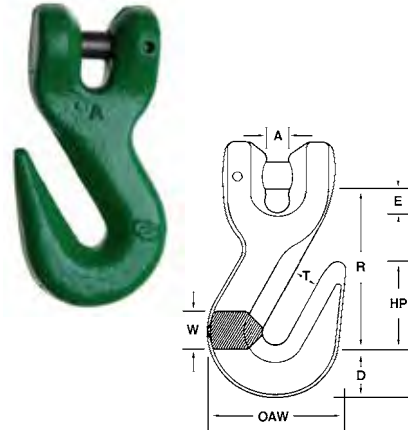

Chain Size	Catalog No.	UPC No. 020418	Grade	Working Load Limit	Weight Each	Shelf Pack
9/32 in	5724415	182600	100	4300 lb	0.60 lb	50
3/8 in	5724615	182617	100	8800 lb	1.60 lb	20
1/2 in	5724815	182624	100	15000 lb	3.50 lb	10
5/8 in	5725015	182631	100	22600 lb	5.40 lb	-
3/4 in	5725215	182648	100	35300 lb	12.40 lb	-

Chain Size	Catalog No.	A Dim.	D Dim.	E Dim.	Load Pin Dia.	HP	OAW	R Dim.	T Dim.	W Dim.
9/32 in	5724415	5/16 in	13/16 in	11/32 in	3/8 in	1-1/4 in	2 in	2-11/32 in	3/8 in	5/8 in
3/8 in	5724615	7/16 in	1-1/4 in	1/2 in	1/2 in	1-5/8 in	2-13/16 in	2-29/32 in	1/2 in	3/4 in
1/2 in	5724815	9/16 in	1-1/2 in	5/8 in	5/8 in	2 in	3-1/2 in	3-23/32 in	21/32 in	15/16 in
5/8 in	5725015	23/32 in	1-3/4 in	3/4 in	3/4 in	2-5/8 in	4-1/8 in	4-7/16 in	25/32 in	1-7/32 in
3/4 in	5725215	13/16 in	2-1/8 in	7/8 in	7/8 in	3-1/4 in	4-7/8 in	5-1/8 in	31/32 in	1-3/8 in

## Quik-Alloy Cradle Grab Hooks

- For use with all Grade 80/100 Chain Slings
- Superior Design Retains 100% of Working Load when used in Choking Applications
- 4:1 Design Factor; Meet or Exceed All Requirements for ASME B30.9 and B30.10
- 100% Proof Tested in Accordance with ASTM A952
- Fatigue Tested
- Forged Hallmarks include Size, Grade, "Campbell", Date Code, and "USA"
- Made in the USA
- DO NOT EXCEED THE WORKING LOAD LIMIT

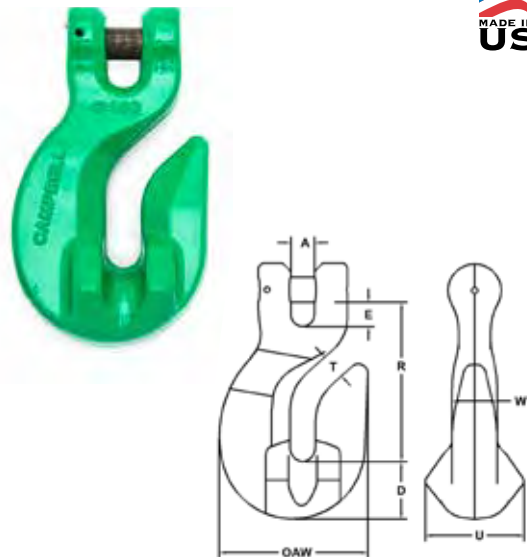

Chain Size	Catalog No.	UPC No. 020418	Grade	Working Load Limit	Weight Each
9/32 in, 5/16 in	5726415	296222	100	5700 lb	1.25 lb
3/8 in	5726615	296215	100	8800 lb	2.40 lb
1/2 in	5726815	296208	100	15000 lb	5.17 lb
5/8 in	5727015	296192	100	22600 lb	8.53 lb

Chain Size	Catalog No.	A Dim.	D Dim.	E Dim.	Load Pin Dia.	OAW	R Dim.	T Dim.	U Dim.	W Dim.
9/32 in, 5/16 in	5726415	11/32 in	27/32 in	3/8 in	3/8 in	2-9/32 in	2-23/32 in	7/16 in	1-15/32 in	3/4 in
3/8 in	5726615	15/32 in	1-9/32 in	15/32 in	1/2 in	2-31/32 in	3-3/16 in	17/32 in	2-1/32 in	13/16 in
1/2 in	5726815	5/8 in	1-15/32 in	19/32 in	5/8 in	3-11/16 in	4-1/4 in	23/32 in	2-13/32 in	1-1/16 in
5/8 in	5727015	23/32 in	1-3/4 in	3/4 in	3/4 in	4-17/32 in	4-27/32 in	25/32 in	3 in	1-3/8 in

SLINGS





## Self-Locking Clevis Hooks

- Meets the Intent of Osha Regulation 1926.550(g)(4)(iv)(b)
- Meet or Exceed All Requirements of ASME B30.9 and B30.10
- Fatigue and 100% Proof Tested in Accordance with ASTM A952
- Additionally Hallmarked with "USA" and Date Code
- Latch Closes Automatically Under Load
- Trigger Assembly is Completely Replaceable
- Made in the USA
- DO NOT EXCEED THE WORKING LOAD LIMIT

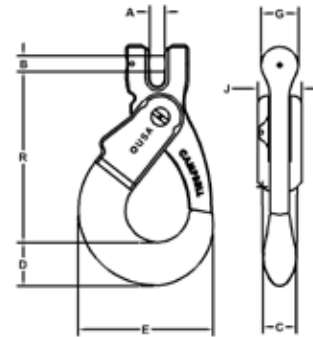

Chain Size	Catalog No.	UPC No. 020418	Grade	Working Load Limit	Weight Each	Shelf Pack
9/32 in	5748495	193309	100	4300 lb	2.35 lb	-
3/8 in	5748695	193316	100	8800 lb	4.10 lb	-
1/2 in	5748895	193323	100	15000 lb	8.75 lb	1
5/8 in	5749095	193330	100	22600 lb	13.30 lb	1

Chain Size	Catalog No.	A Dim.	B Dim.	C Dim.	D Dim.	E Dim.	F Dim.	G Dim.	H Dim.	J Dim.	R Dim.
9/32 in	5748495	0.312 in	0.375 in	0.938 in	1.02 in	3.594 in	1.625 in	1.00 in	0.875 in	1.25 in	4.688 in
3/8 in	5748695	0.438 in	0.500 in	1.125 in	1.25 in	4.312 in	1.875 in	1.125 in	1.063 in	1.50 in	5.563 in
1/2 in	5748895	0.563 in	0.625 in	1.312 in	1.796 in	5.404 in	2.25 in	1.50 in	1.281 in	1.75 in	6.844 in
5/8 in	5749095	0.719 in	0.750 in	1.500 in	2.169 in	6.50 in	2.375 in	1.625 in	1.50 in	2.00 in	8.25 in

## Self-locking Hook Repair Kits

- Trigger Repair Kit for Clevis, Eye and Swivel Self Locking Hooks
- Repair Kit Contents:
  - Pivot Pin
  - Drive Pins (2)
  - Trigger
  - Trigger Spring
  - Spring Alignment Insert (9/32 & 3/8 Kits Only)



Hook Size	Catalog No.	UPC No. 020418	Weight Each
9/32 in	5788495	207518	0.10 lb
3/8 in	5788695	207525	0.20 lb
1/2 in	5788895	210600	1.00 lb
5/8 in	5789095	211874	0.55 lb



## Cam-Alloy "S" Hooks

- Made of Heat-Treated Alloy Steel
- Proof Tested to 2 Times the Working Load Limit
- Meet Proof Test and Design Factor for Use in Alloy Chain Slings
- Working Load Limit is Embossed on the S-Hook Body
- Finish is Self Colored
- Made in the USA
- DO NOT EXCEED THE WORKING LOAD LIMIT

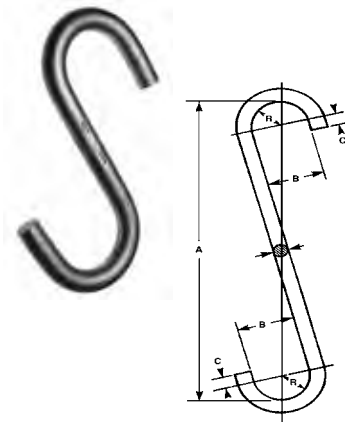

Trade Size	Catalog No.	UPC No. 020418	A Dim.	B Dim.	C Dim.	R Dim.	Working Load Limit	Weight Each
9/32 in	5610405	078262	2.75 in	0.75 in	0.38 in	0.38 in	250 lb	0.07 lb
3/8 in	5610605	078279	4.13 in	1.13 in	0.56 in	0.56 in	500 lb	0.34 lb
1/2 in	5610805	078286	5.50 in	1.50 in	0.75 in	0.75 in	1000 lb	0.59 lb
5/8 in	5611005	078293	7.00 in	1.88 in	0.94 in	0.94 in	1500 lb	1.24 lb
3/4 in	5611205	078309	8.25 in	2.25 in	1.13 in	1.13 in	2000 lb	2.31 lb
1 in	5611605	078323	11.00 in	3.00 in	1.50 in	1.50 in	3200 lb	4.45 lb

## Cam-Alloy "J" Hooks

- Forged Alloy Steel
- Proof Tested to 2 Times the Working Load Limit
- Self Colored Finish
- Made in the USA
- DO NOT EXCEED THE WORKING LOAD LIMIT

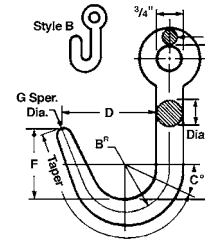

Cat. No.	UPC No. 020418	Style	Material Diameter	Working Load Limit	Weight Each	B Dim.	C (Angle)	D Dim.	E Dim.	F Dim.	G Dim.	H Dim.
5616215	078484	A	3/4 in	2250 lb	0.85 lb	1.31 in	25 °	2.69 in	4.38 in	2.06 in	0.38 in	0.467 in
5616615	078491	B	1 in	3600 lb	2.37 lb	2.00 in	90 °	3.64 in	6.75 in	4.00 in	0.28 in	0.467 in
5616616	189777	A	1 in	3600 lb	2.38 lb	2.00 in	90 °	4.13 in	6.75 in	3.88 in	0.28 in	0.467 in

## Field I.D. Tags

- Designed for Field Attachment
- Pre-Stamped for Easy Addition of Reach, Working Load Limit, Chain Size, Chain Grade and Serial Number
- Tag Measures 1 1/2" X 4 1/8" X 5/32" Thick and Has A 1/16" Diameter Hole
- Cut at Top of Tag Allows You to Attach to Sling Link
- Also Available Solid (Without Split)
- Box of 50 Tags (Order Unit is "Carton")



7503506

7503506C

Catalog No.	UPC No. 020418	Type	Quantity Per Package	Weight Per Carton (Lbs)	Shelf Pack
7503506	135309	Split	50	12.80 lb	1
7503506C	217319	Solid	50	12.80 lb	1

**CLAMPS**

GXL Clamps ..... 157  
GX Clamps ..... 158  
E Clamps..... 161  
Plate Clamps..... 163  
Drum Lifters..... 165  
Drum Deheaders..... 166



## Campbell® Clamps

Though it began manufacturing operations in 1866, Campbell first made its lightweight, rugged plate lifting clamp in 1938. It was designed by an Englishman named Volz. Because it incorporated forged parts of heat treated, alloy steel, the Campbell clamp earned a worldwide reputation for reliability and long life. It is widely used by steel mills, warehouses and fabricating shops and is much preferred because its forged parts give increased strength yet are lightweight.

## Campbell Lifting Clamps

Campbell clamps are known and used throughout the world for lifting, conveying and positioning of sheet, plate, weldments and structurals. The heavier the load, the tighter they grip. Parts are drop forged for strength, dependability and long life, and all clamps are individually proof tested. Replacement parts are available when needed. If you have any doubts as to the clamp best suited to your application, contact your Apex Tool Group salesman.

*NOTICE: The product specifications and dimensions are as accurate as possible at the time of printing. However, because we are constantly improving the quality and design of our products, they can change without notice.*

All Working Load Limits are expressed in Metric Tons.  
1 Metric Ton = 2,204.6 lbs.

### WARNING

1. Do not exceed Working Load Limit stamped on Clamp body.
2. Inspect clamp before each lift.
3. **Stand clear of load when lifting.**
4. Position clamp to balance load.
5. Insert plate or unit to full depth of throat opening.
6. Lift slowly and smoothly. Do not jerk load.
7. Do not lift more than one plate or sheet at a time.
8. Do not use a damaged clamp.
9. Read manufacturer's instructions before using clamps.
10. Do not use any Campbell clamp to lift tapered plates or beams.
11. When lifting plates with a hardness over 43 Rockwell C/400 BRINELL, use non-marring clamps only.
12. Campbell clamps are designed to be used at temperatures between 0°F and 200°F.

## Inspection, Maintenance & Repair

It is important to establish a regular procedure for clamp inspection. Frequency of inspection will depend upon the amount of use the clamp receives. Campbell clamps are built to withstand rough treatment, however, grit, dirt, sludge and mud should be removed. This may be done easily by immersing the entire clamp in a can of degreaser and leaving it there overnight. Also, periodic oiling of all pins and rivets will improve performance and help to extend the life of the clamp. You may wish to maintain a written record, indicating inspection dates, condition of the clamp on each of those dates, and any repairs made. Inspection records should be reviewed periodically.

### ADVERTENCIA

- Las mordazas en este catálogo no fueron diseñadas para ser utilizadas como conexión permanente de una placa o de otros objetos.
- El agarre depende de la fricción y de la presión entre ambas piezas. Si no se les da mantenimiento adecuado a las superficies de agarre y se utiliza la mordaza de manera inadecuada se puede caer la carga.
- Tenga mucha precaución cuando se va a elevar carga por encima de objetos o donde una falla puede ocasionar daños a la propiedad o lesiones personales.
- Lea los instructivos de uso y de mantenimiento.

### WARNING

- The clamps in this catalog are not intended to serve as a permanent connection to a plate or other object.
- The grip depends on friction and a camming action. If the gripping surfaces are not properly maintained and the clamp is improperly used, the load may fall.
- Use extreme caution where overhead lifting is involved or where a failure could cause property damage or personal injury.
- Read maintenance materials and use instructions.



## Inspection Procedure

### 1. Cams – These are the parts likely to receive most wear.

The amount of wear, of course, bears a direct relationship to the use the cam receives. Continued usage of plates of the same thickness will result in wear in only one area of the working surface of the cam, and will eventually require that the cam be replaced. The harder the plate is, the sooner the cam will be worn. A simple visual inspection of the cam is all that is required in most cases. The surfaces of the cam should be compared with unused surfaces. If any one tooth is worn or chipped more than 50% along the length of its crown, the cam should be replaced.

*Note: The Pad and Cam should be replaced at the same time.*

### 2. Pads – The pads of “GX” and “E” clamps are held in with a bolt and can be replaced simply by removing the bolt.

If any one tooth is worn or chipped more than 50% along the length of its crown, the pad should be replaced.

*Note: The Pad and Cam should be replaced at the same time.*

### 3. Spread Jaw – Check the throat width of the clamp.

At zero grip, the cam should be in full contact with the pad. If the width at the base (where the pad is located) is greater than the width at the top, the clamp has been overloaded and should be replaced.

*Warning: Do not weld on the clamp body, as this may destroy the original heat treatment.*

### 4. Linkage and Shackle Inspection – To remove the linkage from a “GX” clamp, remove the load pins from the body.

The pins do not rotate, and under normal load do not require

replacement. They should be inspected for bending, which is caused by overloads, and replaced as needed. Inspect the shackle for bending at the rivet, which is an indication of side pull. If this is a recurrent fault, use a chain connector on the clamp.

### 5. Rivet Inspection— Rivets may require replacement when a very loose connection is detected.

Linkage should normally be free working. Should a rivet hole in the shackle, radius link or connecting link become stretched or enlarged (usually resulting from overloading), those parts should be replaced. It is advisable to replace the rivet as well. To replace any worn parts, drive rivets out over a relief opening, such as a small section of pipe or the opening in a vise.

*Warning: Do not weld or substitute bolts for rivets. Check connecting links to ascertain that they are not bent.*

### 6. Spring inspection – The spring should be of sufficient strength to hold the cam against the pad.

If it is not, the spring should be replaced. In the case of the “E” clamp, the spring should be replaced if it fails to provide initial pressure at near zero grip.

### 7. Chains – Chains supplied with clamps should also be inspected carefully.

To do this, use a Campbell wear gauge. Inspect chains link by link, checking for distorted, stretched or cracked links, nicks or gouges, pitted links and excessive wear of bearing surfaces and barrels.



#### ADVERTENCIA

Para prevenir la posibilidad de una lesión personal seria:

- **NO EXCEDA** los límites de carga de las cadenas o componentes.
- **NO LA UTILICE** para cargar hacia arriba o para izar.
- **NO LA UTILICE** si la cadena o los componentes están visualmente distorsionados o gastados.



#### WARNING

To prevent the possibility of serious bodily injury:

- **DO NOT EXCEED** the working load limits for chain or components.
- **DO NOT USE** for overhead lifting or hoisting.
- **DO NOT USE** if the chain or components are visibly distorted or worn.

## GXL Clamps

- Available in a 1/2, 1, and 2 Metric Ton Capacities
- Can Be Used for Both Vertical and Horizontal to Vertical Lifting Through 180°
- Drop Forged and Heat Treated Components, with Gripping Surfaces of Case Hardened Alloy Steel.
- Exclusive Feature is a Patented Wear Indicator System. When Any of the Cam's Straight Line, Convex Teeth Are Flattened Between Unique Wear Indicator Grooves, It is Time to Change the Cam.
- Note: The Pad and Cam Should Be Replaced at the Same Time
- Newly Designed "Cam Engaging Locking Lever" Keeps the Cam in Contact with the Plate. the Tension Arm and Spring Mechanism Facilitate Attaching and Removing the Clamp. These Clamps Will Not Lift Plate When in the "Lever Open" Position
- Clamps Are 100% Proof Tested and Certificate of Test Supplied with Each Clamp
- Minimum WLL of at Least 10% of the Maximum WLL
- Warning: NEVER Tamper with a Clamps Tension Arm or Spring Mechanism During a Lift.

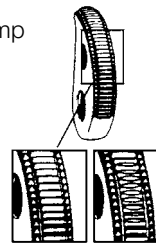
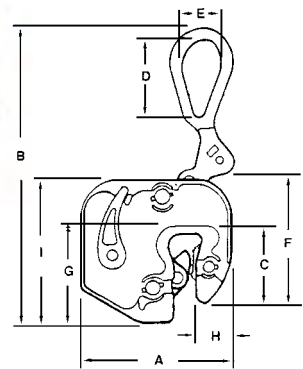

Catalog No.	UPC No. 020418	Grip Range	Working Load Limit (Metric Tons)	Weight Each
6422012	187049	1/16 to 5/8 in.	1/2 t	5.50 lb
6422001	185687	1/16 to 3/4 in.	1 t	8.00 lb
6422002	187032	1/16 to 7/8 in.	2 t	10.50 lb

Catalog No.	Grip Range	A Dim.	B Dim.	C Dim.	D Dim.	E Dim.	F Dim.	G Dim.	H Dim.	I Dim.
6422012	1/16 to 5/8 in.	5-15/16 in	10 in	2-1/8 in	2-5/8 in	2 in	4 in	3-1/4 in	1-3/16 in	5-3/16 in
6422001	1/16 to 3/4 in.	6-9/16 in	11-1/4 in	3-13/16 in	3-1/16 in	2-1/16 in	5 in	3-5/8 in	1-5/8 in	5-7/8 in
6422002	1/16 to 7/8 in.	7-1/4 in	12-1/8 in	2-9/16 in	3-5/16 in	2-1/4 in	4-7/8 in	3-1/2 in	1-5/8 in	5-15/16 in

## Repair Kits for "GXL" Clamps

- Replacement Part Kits for All "GXL" Style Clamps
- Kits Contain All Necessary Parts for Shackle or Cam/Pad Replacement
- Shackle Kit Includes: 1 Shackle, 1 Radius Link, 1 T-Spring, 2 Connecting Links, 1 Radius Link Pin, 1 Pivot, 1 Lever, 1 E-Spring, 2 Sel-Locs, 3 Linkage Rivets, 1 Drive Pin
- Note: Shackle Kit is Supplied Pre-Assembled for Easier Installation
- Cam/Pad Kit Includes: 1 Cam, 1 Pad, 1 Cam Pin, 1 Pad Pin, 1 T-Spring, 1 E-Spring, 1 Rivet, 4 Sel-Locs
- Note: The Cam and Pad Should Be Replaced at the Same Time

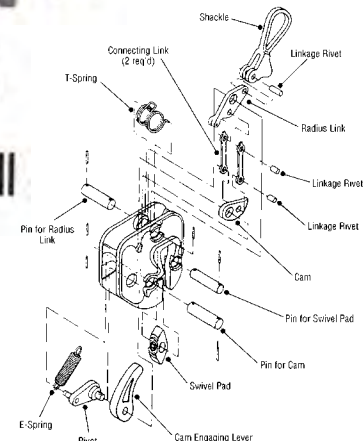

Catalog No.	UPC No. 020418	Part Name	For Use With Clamp Capacity	Weight Each
6506200	210204	Shackle Kit	GX	3.00 lb
6506201	210211	Cam/Pad Kit	GX	0.50 lb
6506210	210228	Shackle Kit	-	3.00 lb
6506211	210235	Cam/Pad Kit	-	1.00 lb
6506220	210242	Shackle Kit	-	3.80 lb
6506221	210259	Cam/Pad Kit	-	1.20 lb

CLAMPS



## GX Clamps

- Features Drop-Forged and Heat Treated Body and Components
- Can Be Used for Both Vertical and Horizontal to Vertical Lifting Through 180°
- Exclusive Feature is a Patented Wear Indicator System. When Any of the Cam's Straight Line, Convex Teeth Are Flattened Between Unique Wear Indicator Grooves, It is Time to Change the Cam.
- Note: The Pad and Cam Should Be Replaced at the Same Time
- Clamps Are 100% Proof Tested and Certificate of Test Supplied with Each Clamp
- Minimum WLL of at Least 10% of the Maximum WLL

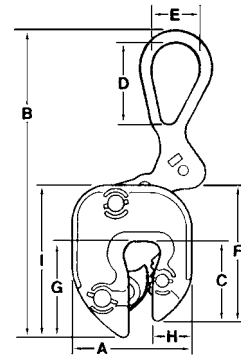

Catalog No.	UPC No. 020418	Grip Range	Working Load Limit (Metric Tons)	Weight Each
6423000	172199	1/16 to 5/8 in.	1/2 t	4.00 lb
6423920	175657	5/8 to 1-1/8 in.	1/2 t	5.00 lb
6423005	172205	1/16 to 3/4 in.	1 t	8.00 lb
6423923	175664	3/4 to 1-3/8 in.	1 t	9.00 lb
6423010	172229	1/16 to 1 in.	3 t	17.00 lb
6423925	175671	1 to 1-3/4 in.	3 t	20.00 lb
6423015	177583	1/2 to 2 in.	5 t	40.00 lb

Catalog No.	Grip Range	A Dim.	B Dim.	C Dim.	D Dim.	E Dim.	F Dim.	G Dim.	H Dim.	I Dim.
6423000	1/16 to 5/8 in.	4 in	9-1/2 in	2-3/16 in	2-3/4 in	2 in	4-1/8 in	2-7/8 in	1-3/8 in	4-7/8 in
6423920	5/8 to 1-1/8 in.	5 in	9-1/2 in	2-3/16 in	2-5/8 in	2 in	4-1/8 in	2-7/8 in	1-5/8 in	4-7/8 in
6423005	1/16 to 3/4 in.	4-3/4 in	11-1/4 in	3-1/16 in	3-1/16 in	2-1/16 in	5-1/4 in	3-5/8 in	1-5/8 in	5-7/8 in
6423923	3/4 to 1-3/8 in.	5-7/8 in	11-1/4 in	3-1/16 in	3-1/16 in	2-1/16 in	5-1/4 in	3-5/8 in	1-5/8 in	5-7/8 in
6423010	1/16 to 1 in.	6 in	14 in	3-9/16 in	3-13/16 in	3 in	6-3/4 in	4-7/16 in	2 in	7-5/8 in
6423925	1 to 1-3/4 in.	7-1/4 in	14 in	3-9/16 in	3-13/16 in	3 in	6-3/4 in	4-7/16 in	2-1/4 in	7-5/8 in
6423015	1/2 to 2 in.	8-7/8 in	20 in	4-11/16 in	5 in	3-15/16 in	8-3/4 in	5-15/16 in	3-13/16 in	9-15/16 in

## Short Leg Structural “GX” Clamps

- Designed for a Secure Bite on Small or Odd Shaped, Wide Flanged Beams
- Can Be Used for Both Vertical and Horizontal to Vertical Lifting Through 180°
- Put Short Leg Under Plate When Lifting From Horizontal to Vertical
- Replacement Parts Are Same As for Standard “GX” Clamps
- Note: The Pad and Cam Should Be Replaced at the Same Time
- Clamps Are 100% Proof Tested and Certificate of Test Supplied with Each Clamp
- Minimum WLL of at Least 10% of the Maximum WLL

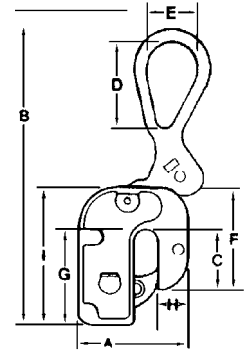

Catalog No.	UPC No. 020418	Grip Range	Working Load Limit (Metric Tons)	Weight Each
6423100	177330	1/16 to 5/8 in.	1/2 t	4.25 lb
6423105	177347	1/16 to 3/4 in.	1 t	8.00 lb
6423108	183041	1/16 to 7/8 in.	2 t	10.00 lb
6423110	177354	1/16 to 1 in.	3 t	18.00 lb

Catalog No.	Grip Range	A Dim.	B Dim.	C Dim.	D Dim.	E Dim.	F Dim.	G Dim.	H Dim.	I Dim.
6423100	1/16 to 5/8 in.	4 in	9-1/2 in	2-1/8 in	2-5/8 in	2 in	4-1/16 in	2-7/8 in	1-3/8 in	4-3/4 in
6423105	1/16 to 3/4 in.	4-3/4 in	11-5/16 in	2-5/8 in	3-1/16 in	2-1/16 in	4-7/8 in	3-9/16 in	1-21/32 in	5-13/16 in
6423108	1/16 to 7/8 in.	5-1/8 in	12-1/8 in	2-5/8 in	3-5/16 in	2-1/4 in	5 in	3-9/16 in	1-5/8 in	5-15/16 in
6423110	1/16 to 1 in.	6 in	15-1/16 in	3-7/16 in	3-13/16 in	3 in	6-9/16 in	4-3/16 in	2 in	7-5/16 in

## Repair Kits for “GX” Clamps

- Replacement Part Kits for All “GX” Style Clamps
- Kits Contain All Necessary Parts for Shackle or Cam/Pad Replacement
- Shackle Kit Includes: 1 Shackle, 1 Radius Link, 1 T-Spring, 2 Connecting Links, 1 Radius Link Pin, 3 Linkage Rivets, 4 Sel-Locs
- Note: Shackle Kit is Supplied Pre-Assembled for Easier Installation
- Cam/Pad Kit Includes: 1 Cam, 1 Pad, 1 Cam Pin, 1 Pad Pin, 1 T-Spring, 1 Rivet, 4 Sel-Locs
- Note: The Cam and Pad Should Be Replaced at the Same Time



Catalog No.	UPC No. 020418	Part Name	For Use With Clamp Capacity	Weight Each
6506000	210013	Shackle Kit	1/2 TON	1.00 lb
6506001	210020	Cam/Pad Kit	1/2 TON	0.50 lb
6506010	210037	Shackle Kit	1 TON	1.00 lb
6506011	210044	Cam/Pad Kit	1 TON	0.80 lb
6506020	210051	Shackle Kit	2 TON	1.00 lb
6506021	210068	Cam/Pad Kit	2 TON	1.50 lb
6506030	210075	Shackle Kit	3 TON	6.00 lb
6506031	210082	Cam/Pad Kit	3 TON	4.00 lb
6506050	210099	Shackle Kit	5 TON	15.00 lb
6506051	210105	Cam/Pad Kit	5 TON	4.50 lb

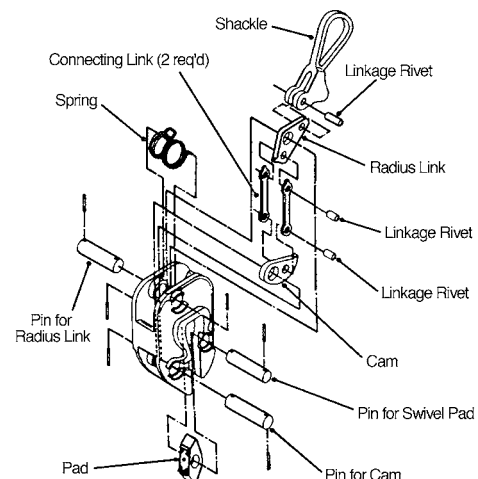





## Chain Connector Clamps

- "GX" Style Chain Connector Clamp
- Clamp Comes Fitted with Chain Connector in Place of the Clamp Shackle
- Use of This Clamp Increases the Flexibility of Multiple Leg Chain Slings
- Clamp is Made of Drop Forged and Heat Treated Alloy Steel
- Minimum WLL of at Least 10% of the Maximum WLL



Catalog No.	UPC No. 020418	Style	Grip Range	Working Load Limit (Metric Tons)	Weight Each
6423900	175947	Regular "GX"	1/16 to 5/16 in.	1/2 t	4.50 lb
6423905	175954	Regular "GX"	1/16 to 3/4 in.	1 t	9.00 lb
6423805	177378	Short Leg Structural "GX"	1/16 to 3/4 in.	1 t	10.00 lb

## GX Rubber Pad (Non-Marring) Clamps

- Has A Rubber Covered Pad
- Cam of Relatively Smooth Metal Conditioned to Grip Tightly
- Should Be Used for Lifting Smooth Polished Plates and/or Hard Plates Over 43 Rockwell C/400 Brinnell
- Lifts Heavy Plates with Minimum Marring
- Clamps Are 100% Proof Tested and Certificate of Test Supplied with Each Clamp
- Minimum WLL of at Least 10% of the Maximum WLL



Catalog No.	UPC No. 020418	Grip Range	Working Load Limit (Metric Tons)	Weight Each	Shelf Pack
6423600	175916	1/16 to 3/8 in.	1/2 t	6.00 lb	-
6423605	175923	1/16 to 5/8 in.	1 t	22.00 lb	1

## Repair Kits for "GX" Rubber Pad Clamps

- Replacement Part Kits for All "GX Rubber Pad" Style Clamps
- Kits Contain All Necessary Parts for Shackle or Cam/Pad Replacement
- Shackle Kit Includes: 1 Shackle, 1 Radius Link, 1 T-Spring, 2 Connecting Links, 1 Radius Link Pin, 3 Linkage Rivets, 2 Sel-Locs
- Note: Shackle Kit is Supplied Pre-Assembled for Easier Installation
- Cam/Pad Kit Includes: 1 Cam, 1 Rubber Pad, 1 Cam Pin, 1 Pad Pin, 1 T-Spring, 1 Rivet, 4 Sel-Locs, 3 Screws
- Note: The Cam and Pad Should Be Replaced at the Same Time



Catalog No.	UPC No. 020418	Part Name	For Use With Clamp Capacity	Weight Each
6506060	210280	Shackle Kit	1/2 TON	1.20 lb
6506061	210297	Cam/Pad Kit	1/2 TON	1.00 lb
6506070	210266	Shackle Kit	1 TON	1.50 lb
6506071	210273	Cam/Pad Kit	1 TON	1.50 lb

## Sharp Leg “GX” Style Clamps

- Designed to Lift Stacked Plates From Horizontal to Vertical Positions in A 90° Arc (Not 180°)
- Long Sharp Leg Can Be Driven Between Top Two Plates to Fully Engage the Clamp
- Clamps Are 100% Proof Tested and Certificate of Test Supplied with Each Clamp
- Minimum WLL of at Least 10% of the Maximum WLL
- Replacement Parts Are Same As for Standard “GX” Clamps

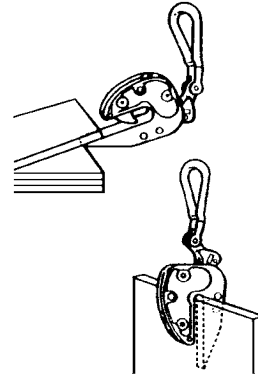

Catalog No.	UPC No. 020418	Grip Range	Working Load Limit (Metric Tons)	Weight Each
6423500	175534	1/16 to 5/8 in.	1/2 t	5.00 lb
6423505	175541	1/16 to 3/4 in.	1 t	9.00 lb

## Locking “E” Clamps

- Clamp Lifts From Either Horizontal or Vertical Position
- Clamps Turn Plates Through 90°
- Locks Open or Closed with a Lever
- Has Large Throat That Gives a Secure Bite and Wide Grip Range
- Clamps Are 100% Proof Tested and Certificate of Test Supplied with Each Clamp
- Minimum WLL of at Least 10% of the Maximum WLL
- Note: Be Sure Clamp is in Lock Closed Position Before Making Lift
- Warning: NEVER Tamper with a Clamps Tension Arm or Spring Mechanism During a Lift. DO NOT Add Rope or Other Material to the Lock Mechanism to Lengthen.

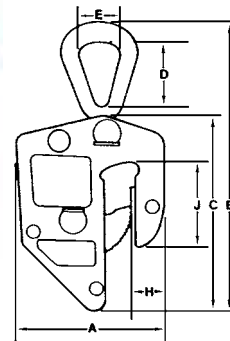

Catalog No.	UPC No. 020418	Model No.	Grip Range	Working Load Limit (Metric Tons)	Weight Each	A Dim.	B Dim.	C Dim.	D Dim.	E Dim.	H Dim.	J Dim.
6420701	096112	3E	0 to 1-1/4 in.	3 t	20.00 lb	7-1/4 in	14-3/8 in	9-1/4 in	3-1/2 in	2 in	2 in	4-3/8 in
6420702	096129	5E	0 to 1-1/2 in.	5 t	28.00 lb	8-7/8 in	16 in	10-1/2 in	3-1/2 in	2-1/2 in	2-11/16 in	5 in
6420703	096136	5E	1-1/4 to 2-1/2 in.	5 t	33.00 lb	10-1/2 in	16-5/8 in	11-1/4 in	3-1/2 in	2-1/2 in	3-1/8 in	5-1/4 in
6420705	096150	8E	1/2 to 2-1/2 in.	8 t	81.00 lb	14-1/8 in	22-3/4 in	15-3/4 in	5 in	3-1/2 in	4-7/8 in	8-1/2 in



## Repair Kits for Locking “E” Clamps

- Replacement Part Kits for All “E” Style Clamps
- Kits Contain All Necessary Parts for Shackle or Cam/Pad Replacement
- Shackle Kit Includes: 1 Shackle, 1 Shackle Bolt, 1 Nut, 1 Cotter Pin
- Cam/Pad Kit w/ Tension Arm Includes: 1 Cam, 1 Pad, 1 Cam Bolt, 1 Pad Bolt, 2 Nuts, 2 Rivets, 1 Drive Pin, 1 Spring, 1 Chain Pull, 1 Chain Pull Clip, 1 Tension Arm, 2 Swivel Pins, 2 Cotter Pins
- Cam/Pad Kit Includes: 1 Cam, 1 Pad, 1 Cam Bolt, 1 Pad Bolt, 2 Nuts, 1 Rivet, 2 Cotter Pins
- Note: The Cam and Pad Should Be Replaced at the Same Time

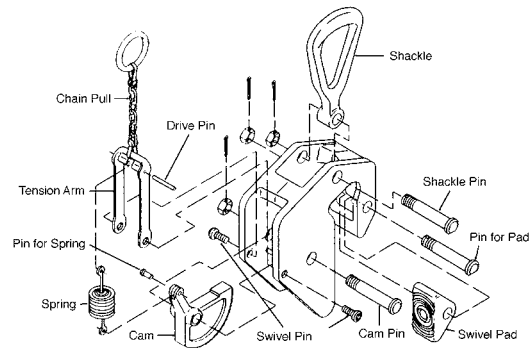

Catalog No.	UPC No. 020418	Part Name	For Use With Clamp Capacity	Grip Range	Weight Each	Shelf Pack
6507030	210440	Shackle Kit	3 TON	All Grips	3.50 lb	-
6507031	210457	Cam/Pad/Tension Arm Kit	3 TON	All Grips	5.00 lb	-
6507032	227684	Cam/Pad Kit	3 TON	All Grips	2.50 lb	1
6507050	210464	Shackle Kit	5 TON	All Grips	3.70 lb	-
6507051	210471	Cam/Pad/Tension Arm Kit	5 TON	All Grips	5.60 lb	-
6507052	227691	Cam/Pad Kit	5 TON	All Grips	4.50 lb	1
6507080	210488	Shackle Kit	8 TON	1/2 - 2 1/2 in.	8.10 lb	-
6507081	210495	Cam/Pad/Tension Arm Kit	8 TON & 12 TON	All Grips	16.50 lb	-
6507082	210426	Shackle Kit	8 TON & 12 TON	8 TON - 2 - 4 in. 12 TON - All Grips	8.10 lb	-
6507083	227677	Cam/Pad Kit	8 TON & 12 TON	All Grips	15.30 lb	1



## SAC (Screw-Adjusted Cam) Plate Clamps

- Recommended for Turning Plates From Horizontal to Vertical As Well As Through A 180° Arc
- The Convex, Serrated Cam Swivels on A Ball Joint So That the Area of Cam Engagement Increases As Load Increases
- Drop Forged Body and Shackle
- Clamps Are 100% Proof Tested and Certificate of Test Supplied with Each Clamp
- Minimum WLL of at Least 10% of the Maximum WLL
- Note: Clamp Features a Torque Limiting Handle to Prevent Overtightening. Screw Needs to Be Hand Tight Only! Do Not Overtighten.

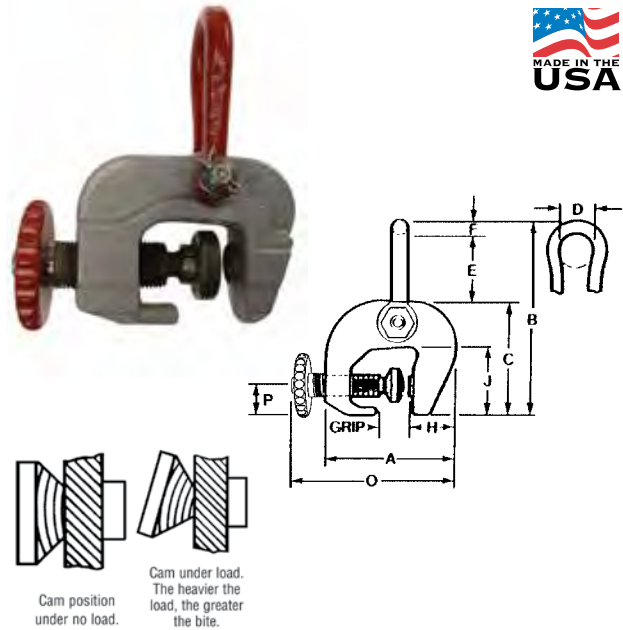

Catalog No.	UPC No. 020418	Model No.	Grip Range	Working Load Limit (Metric Tons)	Weight Each
6421000	096396	SAC-1	0 to 1 in.	1 t	6.25 lb
6421001	096402	SAC-3	0 to 2 in.	3 t	17.00 lb
6421002	096419	SAC-6	0 to 3 in.	6 t	39.00 lb

Catalog No.	A Dim.	B Dim.	C Dim.	D Dim.	E Dim.	F Dim.	H Dim.	J Dim.	O Dim.	P Dim.
6421000	5-1/4 in	7-3/4 in	4 in	1-3/4 in	2-7/8 in	1/2 in	1-1/2 in	2-1/4 in	6-1/4 in	1-23/64 in
6421001	7-3/4 in	10-1/2 in	6-1/2 in	1-7/8 in	3-3/8 in	3/4 in	2-3/8 in	3-3/4 in	9-1/4 in	1-13/16 in
6421002	10 in	14-1/4 in	8-1/4 in	3-1/4 in	4-1/2 in	1-1/8 in	3 in	4-1/2 in	12 in	2-1/4 in

## Repair Kits for SAC Clamps

- Replacement Part Kits for All "SAC" Style Clamps
- Kits Contain All Necessary Parts for Shackle, Screw and Handle or Cam/Pad Replacement
- Cam/Pad Kit Includes: 1 Cam, 1 Pad, 1 Pad Bolt, 1 Nut, 1 Washer
- Screw w/Handle Kit Includes: 1 Screw, 1 Handle
- Shackle w/Bolt Kit Includes: 1 Shackle, 1 Bolt, 1 Nut, 1 Cotter Key
- Note: The Cam and Pad Should Be Replaced at the Same Time

Catalog No.	UPC No. 020418	Part Name	For Use With Clamp Capacity	Weight Each
6501000	210112	Cam/Pad Kit	SAC - 1	0.40 lb
6501101	211942	Screw w/Handle Kit	SAC - 1	1.65 lb
6501111	211959	Shackle w/Bolt Kit	SAC - 1	1.00 lb
6501010	210129	Cam/Pad Kit	SAC - 3	0.80 lb
6501011	211904	Screw w/Handle Kit	SAC - 3	4.25 lb
6501012	211911	Shackle w/Bolt Kit	SAC - 3	2.80 lb
6501020	210136	Cam/Pad Kit	SAC - 6	1.50 lb
6501021	211928	Screw w/Handle Kit	SAC - 6	6.35 lb
6501022	211935	Shackle w/Bolt Kit	SAC - 6	8.35 lb





## Duplex Hand Grip Clamps

- Designed to Carry or Pull Any Object That Will Fit Into Its Jaws
- Features One Piece Cast Alloy Body for Strength and Durability
- Grips and Releases Automatically

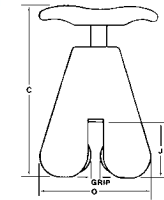
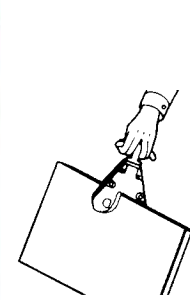

Catalog No.	UPC No. 020418	Grip Range	Handle Length	C Dim.	J Dim.	O Dim.	Weight Each	Shelf Pack
6421801	096693	0 to 5/16 in.	2 in	6 in	1-7/8 in	3-3/4 in	1.15 lb	-
6421802	096709	0 to 5/16 in.	Eye Nut	8 in	1-7/8 in	3-3/4 in	2.10 lb	-
6421803	096716	0 to 5/16 in.	6 in	12 in	1-7/8 in	3-3/4 in	2.00 lb	-
6421805	096723	0 to 5/16 in.	10 in	16 in	1-7/8 in	3-3/4 in	3.00 lb	-
6421806	096730	0 to 5/16 in.	18 in	23 in	1-7/8 in	3-3/4 in	4.00 lb	1

## Horizontal Plate Clamp

- One Person Can Handle Plates with This Clamp
- Dual Springs Hold Cam on the Work While the Second Clamp is Placed
- Sold in Pairs Only
- Clamps Are 100% Proof Tested and Certificate of Test Supplied with Each Clamp

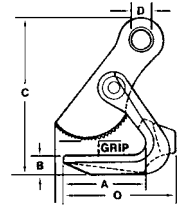
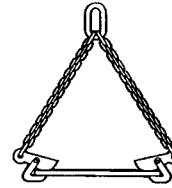

Catalog No.	UPC No. 020418	Model No.	Grip Range	Working Load Limit (Metric Tons)	Cam Width	A Dim.	B Dim.	C Dim.	D Dim.	O Dim.	Weight Per Pair (lbs)
6421701	096686	6H	0 to 1-1/2 in.	6 t	3/4 in	4-1/2 in	1 in	8 in	1 in	7-1/2 in	28.00 lb

## Repair Parts for Horizontal Plate Clamp

- Replacement Kit for Horizontal Plate Clamps
- Cam Kit Includes: 1 Cam, 1 Cam Bolt, 2 Springs, 2 Nuts



Catalog No.	UPC No. 020418	Part Name	For Use With Clamp Capacity	Weight Each
6501700	210433	Cam Kit	Horizontal Plate	5.00 lb

## Single Drum Lifter, No. 52

- Lifts Steel Drums With or Without Heads Removed
- Drums Can Be Lifted From Either Horizontal or Vertical Positions and Then Reversed
- Snaps Onto Drum and is Held There By Its Spring-Loaded Cam Even When There is No Load
- Note: This Clamp is Not Suitable for Lifting Plates or Sheets

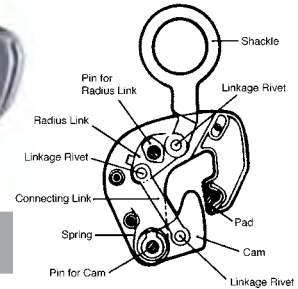

Catalog No.	UPC No.	Model No.	Working Load Limit (Metric Tons)	Overall Width	Bearing to Pad Center	I.D. Of Eye	Bead Recess	Max. Jaw Opening	Weight Each
6410101	095634	52	1/2 t	5 in	6 in	1-3/4 in	1/2 in x 3/4 in	7/8 in	4.75 lb

## Repair Kit for Drum Lifter, No. 52

- Replacement Parts for All "No. 52 & No. 252" Drum Lifter Clamps
- Kits Contain All Necessary Parts for Cam/Pad Replacement
- Cam/Pad Kit Includes: 1 Cam, 1 Pad, 2 Cam Pins, 1 Pad Bolt, 1 Spring, 1 Nut, 2 Cotter Keys



Catalog No.	UPC No.	Model No.	Part Name	For Use With Clamp Capacity	Weight Each
6505011	099823	No. 52 and No. 252	Cam, Pad, Rivet and Spring	Drum Lifter	0.23 lb

## Chain Sling for Drums, No. 13

- Double Sling Assembly Consisting of 9/32 " Alloy Chain, Two No. 52 Drum Lifter Clamps and CO-1 Master Link
- Chain Legs Connected By Quik-Alloy® Coupling Links
- Working Load Limit Rated at 60°



Catalog No.	UPC No.	Model No.	Working Load Limit (Metric Tons)	Overall Length	Alloy Chain Size	Clamp Used	Weight Each
6410301	095665	13	1 t	27 in	9/32 in	6410101	13.00 lb



## Twin Drum Lifter, No. 252

- Handles Both Regular and Resealable Drums Without Damaging Bead
- A Recess on Short Leg of Clamps Accommodates the Bead of Resealable Drums
- See No. 52 Drum Lifter for Replacement Parts

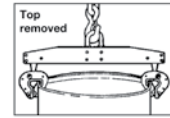
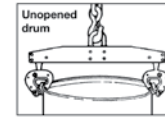

Catalog No.	UPC No.	Model No.	Grip Range	Working Load Limit (Metric Tons)	Overall Length	Weight Each
6410401	095672	252	17-1/2 to 25 in.	1 t	28 in	22.75 lb

## Drum Deheader, No. 138

- All Parts Are Drop Forged and Heat Treated
- Cuts the Heads Out of Steel Drums Without Leaving Dangerous Edges
- Blade and Fulcrum Are Detachable
- For Initial Cut, Tool Has Point in Rear and Striking Surface in Front
- Available with Either Alloy Blade or Non-Sparking Blade
- Drum Deheader Operating Instructions:
  - 1) Open Handles, Place Blade on Top of Steel Drum So That Pivot is on Outside, Below Lip of Drum, Close Handles.
  - 2) Pry Down So Point of Blade Pierces Lid. If Needed, While Prying Down, Strike Back of Blade with Hammer.
  - 3) Lift Handle Slightly, Slide Deheader Forward, Pry Downwards to Cut Lid Further.



Catalog No.	UPC No.	Model No.	Part Name	Length	Weight Each
6410701	095719	138	Deheader with Alloy Balde	24 in	5.50 lb
6410702	095726	139	Deheader with Non-Sparking Blade	24 in	5.50 lb

## Repair Parts for Drum Deheader, No. 138

- Replacement Blade for No.138 and No.139 Drum Deheaders

Catalog No.	UPC No.	Part Name	Weight Each
6500140	098123	Alloy Blade	0.50 lb
6500141	098130	Non-Sparking Blade	0.50 lb



## CHAINS

CATALOG NUMBER		PAGE	CATALOG NUMBER		PAGE
0120202.....	7	0143326.....	9	0304024.....	26
0120232.....	7	0143336.....	9	0309526.....	27
0120300.....	7	0143426.....	9	0310124.....	21
0120302.....	7	0143436.....	9	0310224.....	21
0120322.....	7	0143516.....	9	0310324.....	21
0120330.....	7	0143526.....	9	0310424.....	21
0120332.....	7	0143536.....	9	0311024.....	21
0120400.....	7	0143626.....	9	0312014.....	21
0120402.....	7	0143636.....	9	0312024.....	21
0120422.....	7	0150902.....	11	0313024.....	21
0120430.....	7	0180412.....	12	0314024.....	21
0120432.....	7	0180422.....	12	0315014.....	21
0120500.....	7	0180432.....	12	0315024.....	21
0120502.....	7	0180512.....	12	0320224.....	22
0120522.....	7	0180522.....	12	0320324.....	22
0120530.....	7	0180532.....	12	0321024.....	22
0120532.....	7	0180612.....	12	0322014.....	22
0120600.....	7	0180632.....	12	0322026.....	23
0120602.....	7	0180812.....	12	0324024.....	22
0120622.....	7	0180832.....	12	0325034.....	22
0120630.....	7	0181012.....	12	0329500.....	23
0120632.....	7	0181032.....	12	0330124.....	23
0120732.....	7	0181092.....	14	0330126.....	25
0120802.....	7	0181212.....	12	0330224.....	23
0120822.....	7	0181413.....	13	0330324.....	23
0120832.....	7	0181423.....	13	0330424.....	23
0121002.....	7	0181513.....	13	0331024.....	23
0121032.....	7	0181523.....	13	0331026.....	25
0121202.....	7	0181613.....	13	0332023.....	25
0121232.....	7	0181623.....	13	0332024.....	23
0128102.....	10	0184416.....	13	0332426.....	25
0128132.....	10	0184516.....	13	0333024.....	23
0128232.....	10	0184536.....	13	0334024.....	23
0128302.....	10	0184616.....	13	0335024.....	23
0128332.....	10	0184636.....	13	0335026.....	25
0128432.....	10	0187232.....	14	0336015.....	25
0129332.....	11	0192411.....	20	0339626.....	27
0129432.....	11	0192711.....	20	0340324.....	26
0129532.....	11	0192911.....	20	0400512.....	19
0129632.....	11	0193111.....	20	0401612.....	19
0140323.....	8	0193311.....	20	0402012.....	19
0140333.....	8	0200356.....	8	0405212.....	19
0140423.....	8	0213505.....	41	0405312.....	19
0140433.....	8	0222525.....	42	0405412.....	19
0140523.....	8	0222625.....	42	0405512.....	19
0140533.....	8	0222725.....	42	0405612.....	19
0140623.....	8	0222925.....	42	0405712.....	19
0140633.....	8	0223025.....	42	0405812.....	19
0140823.....	8	0226615.....	42	0406812.....	15
0143226.....	9	0226625.....	42	0407512.....	15
		0231912.....	44	0407612.....	15
		0231916.....	44	0407712.....	15



CATALOG NUMBER	PAGE	CATALOG NUMBER	PAGE	CATALOG NUMBER	PAGE
0510410.....	16	0713627.....	37	0742034.....	28
0510412.....	15	0717017.....	36	0743024.....	28
0510413.....	16	0719017.....	36	0744024.....	28
0510426.....	17	0719027.....	36	0744027.....	29
0510510.....	16	0720127.....	32	0744037.....	29
0510512.....	15	0720427.....	32	0745024.....	28
0510513.....	16	0720428.....	35	0745037.....	29
0510526.....	17	0721627.....	33	0750124.....	30
0510610.....	16	0721667.....	33	0750224.....	30
0510612.....	15	0721727.....	33	0750227.....	32
0510613.....	16	0722000.....	35	0750324.....	30
0510626.....	17	0722002.....	35	0750424.....	30
0510712.....	15	0722003.....	35	0751034.....	30
0510810.....	16	0722004.....	35	0752023.....	31
0510812.....	15	0722006.....	35	0752024.....	30
0513572.....	43	0722007.....	35	0752034.....	30
0513574.....	43	0722010.....	35	0752426.....	31
0513575.....	43	0722027.....	32	0754034.....	30
0513576.....	43	0722087.....	32	0754126.....	31
0513578.....	44	0722127.....	10	0754326.....	31
0513660.....	43	0722227.....	10	0758034.....	30
0513665.....	43	0722327.....	10	0762024.....	31
0513667.....	43	0722427.....	29	0800824.....	32
0513765.....	43	0722527.....	22	0801024.....	32
0514632.....	17	0722627.....	32	0801224.....	32
0514732.....	17	0722827.....	24	0801424.....	32
0514832.....	17	0722927.....	27	0801624.....	32
0514932.....	17	0722957.....	27	0871014.....	29
0516531.....	18	0723167.....	26	0872014.....	29
0516631.....	18	0723169.....	28	0880844.....	34
0520612.....	18	0723227.....	32	0890824.....	34
0520812.....	18	0723367.....	21	0890827.....	34
0521012.....	18	0723388.....	22	0890844.....	34
0635211.....	20	0723427.....	29	0892524.....	34
0635311.....	20	0723627.....	24	0892527.....	34
0702024.....	45	0723727.....	34	0893524.....	34
0710227.....	37	0723817.....	30	0893527.....	34
0710317.....	36	0724027.....	33	0893544.....	34
0710517.....	36	0724527.....	24	0893574.....	34
0710717.....	36	0724627.....	32	0894024.....	34
0711017.....	35	0725027.....	10	0894074.....	34
0711077.....	35	0726427.....	32	0895024.....	34
0711917.....	37	0726627.....	22	0895314.....	35
0712017.....	36	0726727.....	21	0898014.....	35
0712517.....	36	0726827.....	24	0990646.....	38
0712577.....	36	0740224.....	28	0990647.....	38
0713027.....	37	0740234.....	28	0990836.....	38
0713117.....	36	0740237.....	29	0990837.....	38
0713177.....	36	0741024.....	28	0990846.....	38
0713187.....	36	0741034.....	28	0990847.....	38
0713217.....	36	0741037.....	29	0990856.....	38
0713277.....	36	0742024.....	28	0990857.....	38



CATALOG NUMBER	PAGE	CATALOG NUMBER	PAGE	CATALOG NUMBER	PAGE
B7675109	67	T7550403	65	T7615602	59
B7675119	67	T7550404	65	T7615802	59
B7675129	67	T7550421	65	T7615902	59
B7675404	66	T7550501	65	T7616202	56
B7675414	66	T7550502	65	T7616302	59
B7675424	66	T7551522	65	T7616402	59
B7675444	66	T7600311	57	T7616412	59
B7675454	66	T7600511	57	T7616602	59
B7679034	65	T7600531	57	T7620334	60
B7679035	65	T7600561	57	T7620534	60
T3898910	51	T7601201	57	T7620614	60
T3898917	51	T7601311	57	T7620794	58;59
T3898934	51	T7601451	57	T7620804	60
T3898936	51	T7601461	57	T7620934	58;59
T3898954	51	T7601801	58;59	T7625004	60
T3898956	51	T7601912	58;59	T7625014	60
T3898976	51	T7602301	58;59	T7625104	60
T3899720	51	T7602611	58;59	T7625114	60
T3899724	51	T7603211	58;59	T7625124	60
T3899728	51	T7603441	58;59	T7625204	60
T3899733	51	T7603911	58;59	T7625304	60
T3899736	51	T7604002	58;59	T7625314	60
T3899744	51	T7604622	58;59	T7625324	60
T3899752	51	T7605501	57	T7625404	60
T3899760	51	T7605511	57	T7625434	60
T3899768	51	T7605521	57	T7625504	60
T3899776	51	T7605701	57	T7625604	60
T3899910	52	T7605801	57	T7625614	60
T3899913	52	T7605811	57	T7630406	63
T3899916	52	T7605821	57	T7630416	63
T3899919	52	T7606001	57	T7630426	63
T4900324	49	T7606011	57	T7630436	63
T4900424	49	T7606021	57	T7630446	63
T4900524	49	T7606031	57	T7630506	63
T4900624	49	T7606102	58;59	T7630526	63
T4900824	49	T7606301	58;59	T7630536	63
T5423300	50	T7606502	58;59	T7630546	63
T5423301	50	T7606801	58;59	T7630556	63
T5423302	50	T7607301	58;59	T7631204	61
T5800124	50	T7607306	58;59	T7631304	61
T5901024	55	T7607401	58;59	T7631324	61
T5950024	50	T7610102	59	T7631404	61
T5950124	50	T7610832	59	T7631414	61
T5950324	50	T7615012	59	T7631434	61
T5950724	50	T7615102	59	T7631524	61
T5950924	50	T7615202	59	T7631534	61
T7550301	65	T7615302	59	T7631604	61
T7550302	65	T7615312	59	T7631614	61
T7550303	65	T7615402	59	T7631704	61
T7550304	65	T7615412	59	T7631804	61
T7550401	65	T7615422	59	T7633002	68
T7550402	65	T7615502	59	T7633003	68

CATALOG NUMBER	PAGE	CATALOG NUMBER	PAGE	CATALOG NUMBER	PAGE
T7633004.....	68	T7665012.....	55	T9503315.....	70;91
T7637502.....	68	T7665032.....	55	T9503415.....	70;91
T7637503.....	68	T7665042.....	55	T9503515.....	70;91
T7637504.....	68	T7670409.....	67	T9504315.....	71;93
T7640302.....	56	T7670419.....	67	T9504415.....	71;93
T7640322.....	56	T7670429.....	67	T9504515.....	71;93
T7645000.....	61	T7670439.....	67	T9600335.....	68
T7645006V.....	62	T7670449.....	67	T9600435.....	68
T7645016V.....	62	T7670459.....	67	T9600535.....	68
T7645026V.....	62	T7670479.....	67	T9600635.....	68
T7645036V.....	62	T7670489.....	67	T9600835.....	68
T7645046V.....	62	T7670499.....	67	T9601035.....	68
T7645066V.....	62	T7670609.....	67	T9601235.....	68
T7645068V.....	62	T7670619.....	67	T9601635.....	68
T7645074V.....	62	T7670629.....	67	T9620108.....	69
T7645106V.....	62	T7670639.....	67	T9620115.....	69
T7645116V.....	62	T7670649.....	67	T9620121.....	69
T7645126V.....	62	T7670659.....	67	T9620122.....	69
T7645136V.....	62	T7670669.....	67	T9620308.....	69
T7645146V.....	62	T7670904.....	66	T9620315.....	69
T7645156V.....	62	T7670914.....	66	T9620322.....	69
T7655002.....	64	T7670924.....	66	T9630335.....	68;97
T7655012.....	64	T7670944.....	66	T9630435.....	68;97
T7655022.....	64	T7670954.....	66	T9630535.....	68;97
T7655032.....	64	T7691800.....	66	T9630635.....	68;97
T7655042.....	64	T7691801.....	66	T9630835.....	68;97
T7655052.....	64	T7691802.....	66	T9640335.....	69
T7655062.....	64	T7691803.....	66	T9640405.....	53
T7655100.....	64	T7691804.....	66	T9640435.....	69
T7655112.....	64	T9001424.....	70;91	T9640505.....	53
T7655120.....	64	T9001524.....	70;91	T9640535.....	69
T7655132.....	64	T9001624.....	70;91	T9640605.....	53
T7655142.....	64	T9001824.....	70;91	T9640635.....	69
T7655202.....	64	T9101424.....	71;93	T9640705.....	53
T7655212.....	64	T9101524.....	71;93	T9640805.....	53
T7655222.....	64	T9101624.....	71;93	T9640835.....	69
T7655312.....	64	T9101824.....	71;93	T9641005.....	53
T7655402.....	65	T9401424.....	71;93	T9641035.....	69
T7655404.....	65	T9401524.....	71;93	T9641205.....	53
T7655412.....	65	T9401624.....	71;93	T9641235.....	69
T7655422.....	65	T9401824.....	71;93	T9641405.....	53
T7660841.....	55	T9420405.....	53	T9641435.....	69
T7661152.....	55	T9420505.....	53	T9641605.....	53
T7661361.....	55	T9420605.....	53	T9641635.....	69
T7662114.....	55	T9420705.....	53	T9641805.....	53
T7662154.....	55	T9420805.....	53	T9642005.....	53
T7662322.....	55	T9421005.....	53	T9700424.....	71;93
T7662342.....	55	T9501424.....	70;91	T9700524.....	71;93
T7662351.....	55	T9501524.....	70;91	T9700624.....	71;93
T7662372.....	55	T9501624.....	70;91	T9700824.....	71;93
T7663550.....	55	T9501805.....	52		
T7665001.....	55	T9501824.....	70;91		

## FITTINGS

CATALOG NUMBER	PAGE
3625115.....	101
3625135.....	101
3625215.....	101
3625235.....	101
3625315.....	101
3625335.....	101
3625415.....	101
3625435.....	101
3625515.....	101
3625535.....	101
3625615.....	101
3625635.....	101
3626115.....	101
3626215.....	101
3626315.....	101
3630435.....	97
3630535.....	97
3630635.....	97
3630835.....	97
3631035.....	97
3631235.....	97
3631435.....	97
3631635.....	97
3632035.....	97
3640435.....	98
3640535.....	98
3640635.....	98
3640835.....	98
3641035.....	98
3641235.....	98
3641435.....	98
3641635.....	98
3642035.....	98
3899500.....	90
3899501.....	90
3912905IL.....	89
3913105IL.....	89
3913205IL.....	89
3914205IL.....	88
3914235IL.....	88
3914305IL.....	88
3914335IL.....	88
3914405IL.....	88
3914435IL.....	88
3914505IL.....	88
3914535IL.....	88;89
3914705IL.....	88;89
3914735IL.....	88;89
3914905IL.....	88;89
3915105IL.....	88;89

CATALOG NUMBER	PAGE	CATALOG NUMBER	PAGE
3915205IL.....	88;89	4500424.....	92
3922715IL.....	89	4500504.....	92
3922915IL.....	89	4500505.....	92
3923115IL.....	89	4500524.....	92
3923215IL.....	89	4500604.....	92
3923415IL.....	89	4500605.....	92
3924215IL.....	88	4500624.....	92
3924315IL.....	88	4500804.....	92
3924415IL.....	88	4500805.....	92
3924515IL.....	88;89	4501005.....	92
3924715IL.....	88;89	4503315.....	92
3924915IL.....	88;89	4503415.....	92
3925115IL.....	88;89	4503515.....	92
3925215IL.....	88;89	4503615.....	92
3925415IL.....	88;89	4503715.....	92
3940705IL.....	86	4503815.....	92
3940905IL.....	86	4503915.....	92
3941105IL.....	86	4530734.....	90
3941105PL.....	86	4530735.....	90
3942205IL.....	87	4530935.....	90
3942305IL.....	87	5200404.....	110
3942405IL.....	87	5200434.....	110
3942505IL.....	87	5200504.....	110
3942705IL.....	87	5200534.....	110
3942905IL.....	87	5200604.....	110
3943205IL.....	87	5200634.....	110
3950415IL.....	86	5200804.....	110
3950515IL.....	86	5200834.....	110
3950715IL.....	86	5201004.....	110
3951115IL.....	86	5201034.....	110
3951115PL.....	86	5201234.....	110
3951215IL.....	86	5205634.....	111
3951215PL.....	86	5205834.....	111
3951415PL.....	86	5206035.....	111
3952215IL.....	87	5206235.....	111
3952315IL.....	87	5206435.....	111
3952415IL.....	87	5208805.....	110
3952515IL.....	87	5209005.....	110
3952715IL.....	87	5209205.....	110
3952915IL.....	87	5390435.....	78;79
3953115IL.....	87	5390635.....	78;79
3953115PL.....	87	5390695.....	80
3953215IL.....	87	5390835.....	78;79
3953215PL.....	87	5390895.....	80
4403315.....	94	5391035.....	78;79
4403415.....	94	5391095.....	80
4403515.....	94	5391235.....	78;79
4403615.....	94	5391295.....	80
4403715.....	94	5391435.....	78;79
4403815.....	94	5391495.....	80
4500404.....	92	5391635.....	78;79
4500405.....	92	5391695.....	80

CATALOG NUMBER	PAGE	CATALOG NUMBER	PAGE	CATALOG NUMBER	PAGE
5391835.....	78;79	5413235.....	82	6250527.....	106;107
5392035.....	78;79	5413295.....	83	6250528.....	106;107
5392095.....	80	5414035.....	82	6250529.....	106;107
5392235.....	78;79	5420505.....	84	6250533.....	106;107
5392295.....	80	5420605.....	84	6250534.....	106;107
5392435.....	78;79	5420705.....	84	6260201.....	99
5392495.....	80	5420805.....	84	6260202.....	99
5392835.....	78;79	5430535.....	84	6260203.....	99
5392895.....	80	5430635.....	84	6260205.....	99
5393235.....	78;79	5430835.....	84	6260206.....	99
5393295.....	80	5431035.....	84	6260207.....	99
5394035.....	78;79	5431635.....	84	6260208.....	99
5394095.....	80	6250101.....	108	6260209.....	99
5410335.....	82	6250103.....	108	6260210.....	99
5410405.....	81	6250105.....	108	6260301.....	99
5410435.....	82	6250106.....	108	6260301N.....	99
5410505.....	81	6250107.....	108	6260302.....	99
5410535.....	82	6250111.....	108	6260302N.....	99
5410605.....	81	6250302.....	108	6260303.....	99
5410635.....	82	6250303.....	108	6260303N.....	99
5410695.....	83	6250305.....	108	6260304.....	99
5410705.....	81	6250306.....	108	6260304N.....	99
5410735.....	82	6250307.....	108	6312035.....	48
5410805.....	81	6250309.....	108	6312036.....	48
5410835.....	82	6250313.....	108	6402104.....	83
5410895.....	83	6250315.....	108	6402106.....	83
5411005.....	81	6250324.....	108	6402107.....	83
5411035.....	82	6250328.....	108	6402108.....	83
5411095.....	83	6250403.....	107	6402110.....	83
5411205.....	81	6250405.....	107	6402112.....	83
5411235.....	82	6250406.....	107	6402406.....	80
5411295.....	83	6250407.....	107	6402408.....	80
5411405.....	81	6250409.....	107	6402410.....	80
5411435.....	82	6250427.....	107	6403002.....	76
5411495.....	83	6250501.....	106;107	6403003.....	76
5411605.....	81	6250502.....	106;107	6403004.....	76
5411635.....	82	6250503.....	106;107	6403006.....	76
5411695.....	83	6250505.....	106;107	6403008.....	76
5411805.....	81	6250506.....	106;107	6990234.....	75
5411835.....	82	6250507.....	106;107	6990334.....	75
5412005.....	81	6250510.....	106;107	6990434.....	75
5412035.....	82	6250511.....	106;107	6990534.....	75
5412095.....	83	6250513.....	106;107	6990634.....	75
5412205.....	81	6250514.....	106;107	6990734.....	75
5412235.....	82	6250515.....	106;107	6990834.....	75
5412295.....	83	6250516.....	106;107	6990934.....	75
5412405.....	81	6250519.....	106;107	6991034.....	75
5412435.....	82	6250520.....	106;107	6991234.....	75
5412495.....	83	6250521.....	106;107	6991434.....	75
5412805.....	81	6250522.....	106;107	6991634.....	75
5412835.....	82	6250523.....	106;107	6991834.....	75
5413205.....	81	6250524.....	106;107	6992034.....	75



## SLINGS

CATALOG NUMBER	PAGE
3990401.....	143
3990601.....	143
3990701.....	143
3991001.....	143
3991409.....	143
5610405.....	153
5610605.....	153
5610805.....	153
5611005.....	153
5611205.....	153
5611605.....	153
5616215.....	153
5616615.....	153
5616616.....	153
5621615.....	144
5624415.....	144
5624615.....	144
5624815.....	144
5625015.....	144
5625215.....	144
5625415.....	144
5641615.....	142
5645415.....	142
5646415.....	142
5646495.....	142
5646615.....	142
5646695.....	142
5646815.....	142
5646895.....	142
5647015.....	142
5647215.....	142
5648495.....	144
5648695.....	144
5648895.....	144
5649095.....	144
5661615.....	143
5662015.....	143
5664415.....	143
5664615.....	143
5664815.....	143
5665015.....	143
5665215.....	143
5665415.....	143
5682215.....	146
5682315.....	146
5682415.....	146
5682515.....	146
5682615.....	146
5682715.....	146
5683215.....	145

CATALOG NUMBER	PAGE
5683315.....	145
5683315VW.....	146
5683415.....	145
5683415VW.....	146
5683515.....	145
5683515VW.....	146
5683615.....	145
5683615VW.....	146
5683715.....	145
5685615.....	145
5687015.....	145
5687215.....	145
5724415.....	151
5724615.....	151
5724815.....	151
5725015.....	151
5725215.....	151
5726415.....	151
5726615.....	151
5726815.....	151
5727015.....	151
5746415.....	150
5746495.....	150
5746615.....	150
5746695.....	150
5746815.....	150
5746895.....	150
5747015.....	150
5747095.....	150
5747215.....	150
5747295.....	150
5748495.....	152
5748695.....	152
5748895.....	152
5749095.....	152
5770315.....	149
5771615.....	149
5772015.....	149
5779165.....	149
5779175.....	149
5779225.....	149
5779235.....	149
5779245.....	149
5779255.....	149
5784165.....	149
5784465.....	149
5785425.....	149
5785435.....	149
5785445.....	149
5785455.....	149
5788495.....	152
5788695.....	152

CATALOG NUMBER	PAGE
5788895.....	152
5789095.....	152
5798495.....	145
5798695.....	145
5798895.....	145
5799095.....	145
7503506.....	153
7503506C.....	153
7506495.....	143
7506695.....	143
7506895.....	143
7507095.....	143
7507295.....	143

## CLAMPS

6410101.....	165
6410301.....	165
6410401.....	166
6410701.....	166
6410702.....	166
6420701.....	161
6420702.....	161
6420703.....	161
6420705.....	161
6421000.....	163
6421001.....	163
6421002.....	163
6421701.....	164
6421801.....	164
6421802.....	164
6421803.....	164
6421805.....	164
6421806.....	164
6422001.....	157
6422002.....	157
6422012.....	157
6423000.....	158
6423005.....	158
6423010.....	158
6423015.....	158
6423100.....	159
6423105.....	159
6423108.....	159
6423110.....	159
6423500.....	161
6423505.....	161
6423600.....	160
6423605.....	160
6423805.....	160



CATALOG NUMBER	PAGE
6423900.....	160
6423905.....	160
6423920.....	158
6423923.....	158
6423925.....	158
6500140.....	166
6500141.....	166
6501000.....	163
6501010.....	163
6501011.....	163
6501012.....	163
6501020.....	163
6501021.....	163
6501022.....	163
6501101.....	163
6501111.....	163
6501700.....	164
6505011.....	165
6506000.....	159
6506001.....	159
6506010.....	159
6506011.....	159
6506020.....	159
6506021.....	159
6506030.....	159
6506031.....	159
6506050.....	159
6506051.....	159
6506060.....	160
6506061.....	160
6506070.....	160
6506071.....	160
6506200.....	157
6506201.....	157
6506210.....	157
6506211.....	157
6506220.....	157
6506221.....	157
6507030.....	162
6507031.....	162
6507032.....	162
6507050.....	162
6507051.....	162
6507052.....	162
6507080.....	162
6507081.....	162
6507082.....	162
6507083.....	162



**Apex Tool Group**

**World Headquarters**

14600 York Road, Suite A  
Sparks, MD 21152  
Tel: 410-773-7800  
Fax: 410-472-2051

**Customer Service U.S.**

**TELEPHONE:**

North ..... 866-907-9706  
South ..... 866-907-9706  
Midwest ..... 866-907-9716  
West/SW ..... 866-907-9716  
Hardware ..... 919-362-1670

**FAX:**

North ..... 800-854-5137  
South ..... 800-854-5137  
Midwest ..... 800-546-7312  
West/SW ..... 800-546-7312  
Hardware ..... 877-387-0415  
Export ..... 919-387-2402

**Customer Service Canada**

Phone ..... 866-691-6212  
..... 705-728-3888  
Fax ..... 800-403-8665  
..... 705-728-6634



14600 York Road, Suite A  
Sparks, MD 21152  
[www.apextoolgroup.com](http://www.apextoolgroup.com)